

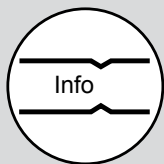

W katalogu tym znajdziesz szeroką gamę szybkozłączy i przewodów stosowanych w układach chłodzenia w Przetwórstwie Tworzyw Sztucznych.



Duńska firma TALKOB jest jednym z wiodących producentów szybkozłączy oraz elementów i akcesoriów do budowy układów chłodzenia form w przetwórstwie tworzyw sztucznych.

Nowoczesny park maszynowy oraz rygorystyczne przestrzeganie procedur produkcyjnych są podstawą wysokiej jakości oferowanych produktów, które czynią z firmy TALKOB rzetelnego i wiarygodnego partnera handlowego.

W wyniku stałych prac badawczych i konstrukcyjnych, prowadzonych przez wykwalifikowany personel firmy powstał unikalny produkt, jakim jest złącze z systemem SAFE-LOCK, w pełni odpowiadające najnowszemu, europejskim dyrektywom bezpieczeństwa.



Ważną cechą oferty firmy TALKOB jest jej kompleksowy charakter. W niniejszym katalogu znajdziecie Państwo trzy najpowszechniej stosowane systemy szybkozłącznie jak również ciekawą ofertę przewodów i akcesoriów.

Budowa szybkozłączy

korpus zaworu	mosiądz MS58
zawór	mosiądz MS58
tuleja ryglująca	mosiądz niklowany
część gwintowana	mosiądz MS58
kulki ryglujące	stal nierdzewna
sprężyna	stal nierdzewna
uszczelniania	Viton (FKM)
wtyczka	mosiądz lub stal nierdz.

Parametry szybkozłączy

ciśnienie robocze	20 bar
temperatura	do 200 °C

Parametry przewodów

ciśnienie robocze	15 bar
temp. max. dla przewodu z EPDM	+ 140 °C
temp. max. dla przewodu z NBR	+ 150 °C
temp. max. dla przewodu z PVC	+ 60 °C
temp. max. dla przewodu z SILOKONU	+ 170 °C
temp. max. dla przewodu z VITONU	+ 200 °C

Legenda piktogramów



- odporność temperaturowa



- przewód do wody,



- przewód do oleju,

Spis treści

Szybkozłącza z systemem bezpieczeństwa Safe-Lock		str. 1
Szybkozłącza w systemie niemieckim, profil EURO	serie 65, 90, 20	str. 2
Szybkozłącza w systemie amerykańskim, profil D-M-E	serie 70, 95, 50	str. 4
Szybkozłącza w systemie francuskim, profil FR	serie 80, 120	str. 6
Przewody		str. 8
Akcesoria		str. 10
Panele multizłączne		str. 13

Szybkozłącza z systemem bezpieczeństwa SAFE-LOCK są zaprojektowane i wytwarzane zgodnie w wymogami unijnej dyrektywy EU 97/23/EF załącznik nr.1.



Szybkozłącza z systemem SAFE-LOCK

- eliminują ryzyko wypadków
- uniemożliwiają rozłączenie pod ciśnieniem
- są dostępne w standardzie EURO i D-M-E
- kompatybilne z wtyczkami standardu EURO i D-M-E
- odporne na olej i wodę do temperatury 180 °C

Dlaczego należy stosować system SAFE-LOCK

Większość systemów chłodzenia w przetwórstwie tworzyw sztucznych pracuje w przedziale temperatur pomiędzy

80 a 170°C. Znaczna część stosowanych w tych układach szybkozłączy jest bezzaworowa. System Safe-Lock stanowi unikalne rozwiązanie, zabezpieczające operatora przez poparzeniem oraz innymi następstwami rozłączenia niezabezpieczonych właściwie układów chłodzenia.

Jak działa system SAFE-LOCK ?

Gniazdo szybkozłącza Safe-Lock zostało wyposażone w specjalny mechanizm blokujący możliwość wypięcia wtyczki jeżeli wewnątrz układu panuje ciśnienie.

Elastyczny pierścień, znajdujący się w tylnej części tulei ryglującej, pod wpływem ciśnienia przepływającego medium rozszerza się uniemożliwiając powrotny ruch tulei i uwolnienie wtyczki.

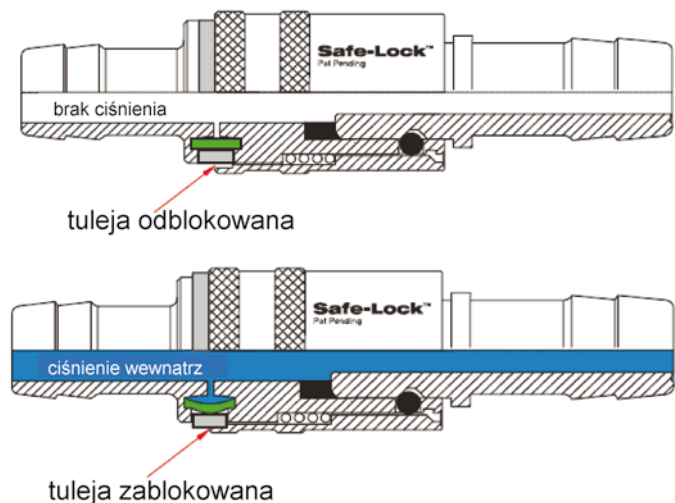

Bez strat przepływu

Stosując tradycyjne szybkozłącza, nieposiadające systemy Safe-Lock, aby uzyskać podobny poziom bezpieczeństwa niezbędne byłoby użycie zarówno gniazda jak i wtyczki z zaworem odcinającym. Takie rozwiązanie jest nie tylko dużo droższe ale również znacznie mniej efektywne ze względu na nieporównywalnie większe opory przepływu a co za tym idzie mniejszą sprawność układów chłodzenia.



Dostępność opcji SAFE-LOCK

Safe-Lock jest wyposażeniem opcjonalnym. Modele szybkozłączy dostępne w wersji Safe-Lock są oznaczone takim znakiem.



Chcąc zamówić produkt z mechanizmem Safe-Lock należy na końcu kodu produktu standardowego dodać oznaczenie ... SL

Gniazdo z tuleją na wąż



Seria	S	Kod - z zaworem	Kod - bez zaworu	D	L	A	L1
65	6	TL6510	TL6510OV	18	52	10 mm	22
90	9	TL9013	TL9013OV	23	61,5	13 mm	25
20	13	TL2019	TL2019OV	31	90	19 mm	32

 - Safe-Lock jest opcją (do kodu należy dodać - SL)

TL...

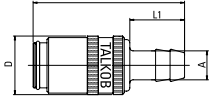

Gniazdo z tuleją na wąż / 90 stopni



Seria	S	Kod - z zaworem	Kod - bez zaworu	D	L	A	L1
65	6	TV6510/90	TV6510/90OV	18	41	10 mm	22
90	9	TV9013/90	TV9013/90OV	23	51	13 mm	28,5
20	13	TV2019/90	TV2019/90OV	32	78	19 mm	32

 - Safe-Lock jest opcją (do kodu należy dodać - SL)

TV.../90

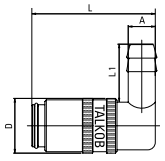

Gniazdo z tuleją na wąż / 45 stopni



Seria	S	Kod - z zaworem	Kod - bez zaworu	D	L	A	L1
65	6	TV6510/45	TV6510/45OV	18	52	10 mm	22
90	9	TV9013/45	TV9013/45OV	23	51	13 mm	25
20	13	TV2019/45	TV2019/45OV	32	78	19 mm	30

 - Safe-Lock jest opcją (do kodu należy dodać - SL)

TV.../45

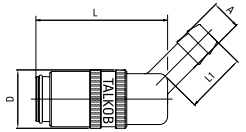

Gniazdo z gwintem zewnętrznym



Seria	S	Kod - z zaworem	Kod - bez zaworu	D	L	A	SW
65	6	TU65M14	TU65M14OV	18	48	M14 x 1,5	17
65	6	TU651/4	TU651/4OV	18	48	1/4"	17
65	6	TU653/8	TU653/8OV	18	48	3/8"	19
90	9	TU901/4	TU901/4OV	23	51,5	1/4"	22
90	9	TU90M16	TU90M16OV	23	51,5	M16 x 1,5	22
90	9	TU903/8	TU903/8OV	23	51,5	3/8"	22
90	9	TU901/2	TU901/2OV	23	54,5	1/2"	22
20	13	TU201/2	TU201/2OV	32	74	1/2"	30
20	13	TU203/4	TU203/4OV	32	78	3/4"	30
20	13	TU20M24	TU20M24OV	32	78	M24 x 1,5	30

 - Safe-Lock jest opcją (do kodu należy dodać - SL)

TU...

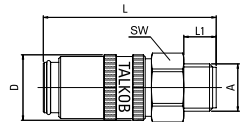

Gniazdo z gwintem wewnętrznym



Seria	S	Kod - z zaworem	Kod - bez zaworu	D	L	A	SW
65	6	TI651/4	TI651/4OV	18	41	1/4"	17
65	6	TI653/8	TI653/8OV	18	45	3/8"	19
90	9	TI901/4	TI901/4OV	23	46,5	1/4"	21
90	9	TI903/8	TI903/8OV	23	46,5	3/8"	21
90	9	TI90M16	TI90M16OV	23	46,5	M16 x 1,5	21

TI...

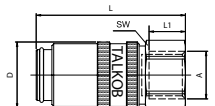

Gniazdo z gwintemzew. / 90 stopni



Seria	S	Kod - z zaworem	Kod - bez zaworu	D	L	A	SW
65	6	TVU65M14/90	TVU65M14/90OV	18	47	M14	17
65	6	TVU651/4/90	TVU651/4/90OV	18	47	1/4"	17
90	9	TVU90M16/90	TVU90M16/90OV	23	53,5	M16 x 1,5	22
20	13	TVU20M24/90	TVU20M24/90OV	32	80	M24 x 1,5	30

TVU.../90

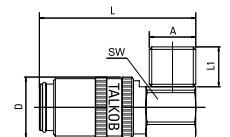

Gniazdo z gwintemzew. / 45 stopni



Seria	S	Kod - z zaworem	Kod - bez zaworu	D	L	A	SW
65	6	TVU65M14/45	TVU65M14/45OV	18	47	M14 x 1,5	17
65	6	TVU651/4/45	TVU651/4/45OV	18	47	1/4"	17
90	9	TVU90M16/45	TVU90M16/45OV	23	53,5	M16 x 1,5	22
20	13	TVU20M24/45	TVU20M24/45OV	32	80	M24 x 1,5	30

TVU.../45

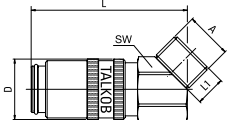

Mostek



Seria	S	Kod - z zaworem	Kod - bez zaworu	D	L	L1	D2
65	6		TS65125	18	43	125	8
65	6		TS65250	18	43	250	8
65	6		TS65500	18	43	500	8
90	9		TS90125	23	53	125	10
90	9		TS90250	23	53	250	10
90	9		TS90500	23	53	500	10
20	13		TS20160	32	80	160	14
20	13		TS20315	32	80	315	14
20	13		TS20500	32	80	500	14

TS...

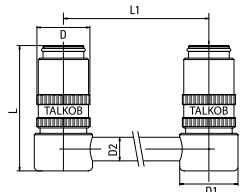

Szybkozłącza do form wtryskowych

typ niemiecki - 65, 90, 20



Wtyczka z gwintem zewnętrznym



Seria	S	Kod - z zaworem	Kod - bez zaworu	L	D	A	SW
65	6		TN65M8	24	9	M8 x 0,75	11
65	6		TN651/8	24	9	1/8"	11
65	6		TN65M10	24	9	M10 x 1	11
65	6		TN65M12	27	9	M12 x 1,5	14
65	6	TN65M14V	TN65M14	26	9	M14 x 1,5	15
65	6	TN651/4V	TN651/4	26	9	1/4"	15
65	6		TN653/8	30	9	3/8"	17
90	9		TN901/8	25	13,5	1/8"	14
90	9		TN90M14	26	13,5	M14 x 1,5	15
90	9		TN901/4	26	13,5	1/4"	15
90	9	TN901/4V		31	13,5	1/4"	15
90	9		TN90M16	26	13,5	M16 x 1,5	17
90	9	TN90M16V		30	13,5	M16 x 1,5	17
90	9		TN903/8	26	13,5	3/8"	17
90	9	TN903/8V		30	13,5	3/8"	17
20	13		TN201/2	47	19	1/2"	22
20	13		TN203/4	51	19	3/4"	27
20	13		TN20M24	51	19	M24 x 1,5	27

TN...

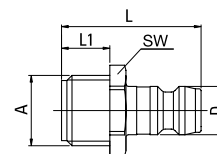

Wtyczka z gwintem zewnętrznym stal nierdzewna



Seria	S	Kod - z zaworem	Kod - bez zaworu	L	D	A	SW
65	6		TN65M8INOX	24	9	M8 x 0,75	11
65	6		TN651/8INOX	24	9	1/8"	11
65	6		TN65M10INOX	24	9	M10 x 1	11
65	6		TN651/4INOX	26	9	1/4"	15
90	9		TN901/4INOX	26	13,5	1/4"	15
90	9		TN903/8INOX	26	13,5	3/8"	17

TN...IONX

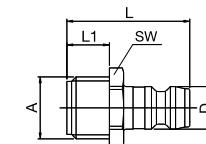

Wtyczka przedłużana 100 mm



Seria	S	Kod - z zaworem	Kod - bez zaworu	L	L1	A	SW
65	6		TN651/8/100	100	60	1/8"	11
65	6		TN651/4/100	100	60	1/4"	14
90	9		TN901/4/100	100	60	1/4"	14
90	9		TN903/8/100	100	60	3/8"	19

TN.../100

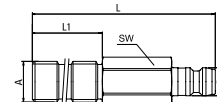

Wtyczka przedłużana bez gwintu



Seria	S	Kod - z zaworem	Kod - bez zaworu	L	L1	A	SW
65	6		TN6508/63	63	42	8	9
65	6		TN6508/100	100	79	8	9
65	6		TN6510/120	120	100	10	11
65	6		TN6510/240	240	220	10	11
65	6		TN6510/360	360	340	10	11
90	9		TN9014/150	150	125	14	15
90	9		TN9014/300	300	275	14	15
90	9		TN9014/450	450	425	14	15
20	13		TN2021/500	500	465	21	22
20	13		TN2021/800	800	765	21	22

TN.../...

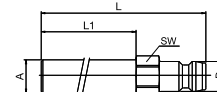

Wtyczka gwint, kątowna 90 stopni



Seria	S	Kod - z zaworem	Kod - bez zaworu	L	L2	A	SW
65	6		TNV65M8	27	28,5	M8 x 0,75	11
65	6		TNV651/8	27	28,5	1/8"	11
65	6		TNV65M10	27	28,5	M10 x 1	11
65	6		TNV651/4	27	28,5	1/4"	11
90	9		TNV90M14	34	32	M14 x 1,5	15
90	9		TNV901/4	34	32	1/4"	15
90	9		TNV903/8	34	32	3/8"	15
20	13		TNV20M24	47	54	M24 x 1,5	24
20	13		TNV201/2	47	54	1/2"	24

TNV...

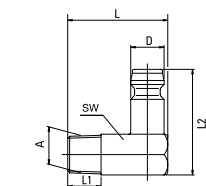

Wtyczka z tuleją do węża



Seria	S	Kod - z zaworem	Kod - bez zaworu	L	L1	A	D
65	6		TN6510	38	22	10 mm	9
90	9		TN9010	41	25	10 mm	13,5
90	9		TN9013	41	25	13 mm	13,5
20	13		TN2013	61	32	13 mm	19
20	13		TN2019	61	32	19 mm	19

TN...

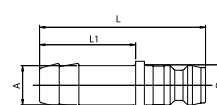

Wtyczka z gwintem wewnętrznym



Seria	S	Kod - z zaworem	Kod - bez zaworu	L	L1	A	SW
65	6		TNI651/8	24	7	1/8"	11
65	6		TNI651/4	27	8	1/4"	16
90	9		TNI901/4	33	8	1/4"	16

TNI...

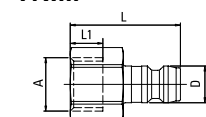

Szybkozłącza do form wtryskowych

D-M-E, typ amerykański - seria 70, 95, 50

Gniazdo z tuleją na wąż



Seria	S	Kod - z zaworem	Kod - bez zaworu	D	L	A	L1
70	6	TL7006	TL7006OV	18	46	6 mm	17
70	6	TL7010	TL7010OV	18	51	10 mm	22
95	9	TL9510	TL9510OV	24	64	10 mm	22
95	9	TL9513	TL9513OV	24	66,5	13 mm	25
50	16		TL5019OV	32	89	19 mm	32

TL...

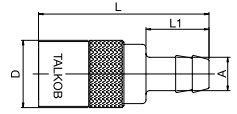

 - Safe-Lock jest opcją (do kodu należy dodać - SL)

Gniazdo z tuleją na wąż / 90 stopni



Seria	S	Kod - z zaworem	Kod - bez zaworu	D	L	A	L1
70	6	TV7006/90	TV7006/90OV	18	40	6 mm	19
70	6	TV7010/90	TV7010/90OV	18	40	10 mm	19
95	9	TV9510/90	TV9510/90OV	24	56	10 mm	19
95	9	TV9513/90	TV9513/90OV	24	56	13 mm	28,5
50	16		TV5019/90OV	32	77	19 mm	32

TV.../90

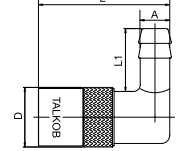

 - Safe-Lock jest opcją (do kodu należy dodać - SL)

Gniazdo z tuleją na wąż / 45 stopni



Seria	S	Kod - z zaworem	Kod - bez zaworu	D	L	A	L1
70	6	TV7006/45	TV7006/45OV	18	55,5	6 mm	19
70	6	TV7010/45	TV7010/45OV	18	55,5	10 mm	19
95	9	TV9510/45	TV9510/45OV	24	71	10 mm	19
95	9	TV9513/45	TV9513/45OV	24	75	13 mm	25
50	16		TV5019/45OV	32	77	19 mm	30

TV.../45

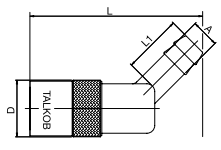

 - Safe-Lock jest opcją (do kodu należy dodać - SL)

Gniazdo z gwintem zewnętrznym



Seria	S	Kod - z zaworem	Kod - bez zaworu	D	L	A	SW
70	6	TU701/4	TU701/4OV	18	47	1/4"	17
70	6	TU703/8	TU703/8OV	18	47	3/8"	19
95	9	TU951/4	TU951/4OV	24	56,5	1/4"	22
95	9	TU953/8	TU953/8OV	24	56,5	3/8"	22
95	9	TU951/2	TU951/2OV	24	59,5	1/2"	22
50	16		TU501/2OV	32	73	1/2"	30
50	16		TU503/4OV	32	77	3/4"	30

TU...

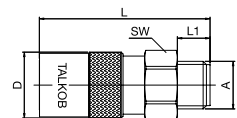

 - Safe-Lock jest opcją (do kodu należy dodać - SL)

Gniazdo z gwintem wewnętrznym



Seria	S	Kod - z zaworem	Kod - bez zaworu	D	L	A	SW
70	6	TI701/8	TI701/8OV	18	40	1/8"	17
70	6	TI701/4	TI701/4OV	18	40	1/4"	17
70	6	TI703/8	TI703/8OV	18	44	3/8"	19
95	9	TI951/4	TI951/4OV	24	51,5	1/4"	21
95	9	TI953/8	TI953/8OV	24	51,5	3/8"	21

TI...

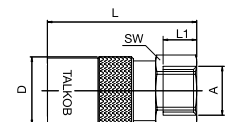

Gniazdo z gwintemzew. / 90 stopni



Seria	S	Kod - z zaworem	Kod - bez zaworu	D	L	A	SW
70	6	TVU701/4/45	TVU701/4/45OV	18	46	1/4"	17

TVU.../90

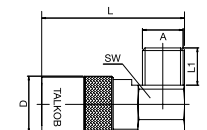

Gniazdo z gwintemzew. / 45 stopni



Seria	S	Kod - z zaworem	Kod - bez zaworu	D	L	A	SW
70	6	TVU701/4/45	TVU701/4/45OV	18	46	1/4"	17

TVU.../45

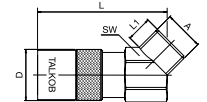

Mostek



Seria	S	Kod - z zaworem	Kod - bez zaworu	D	L	L1	D2
70	6		TS70125	18	42	125	8
70	6		TS70250	18	42	250	8
70	6		TS70500	18	42	500	8
95	9		TS95125	24	58	125	10
95	9		TS95250	24	58	250	10
95	9		TS95500	24	58	500	10
50	13		TS50160	32	78	160	14
50	13		TS50315	32	78	315	14
50	13		TS50500	32	78	500	14

TS...

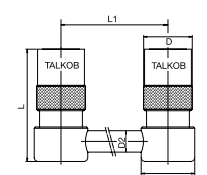

Szybkozłącza do form wtryskowych

D-M-E, typ amerykański - seria 70, 95, 50



Wtyczka z gwintem zewnętrznym



Seria	S	Kod - z zaworem	Kod - bez zaworu	L	D	A	SW
70	6		TN701/8	24	9,5	1/8"	13
70	6		TN70M10	23	9,5	M10	13
70	6	TN701/4V	TN701/4	29	9,5	1/4"	16
70	6		TN703/8	30	9,5	3/8"	19
95	9	TN951/4V	TN951/4	34	13,5	1/4"	16
95	9	TN953/8V	TN953/8	34	13,5	3/8"	19
95	9		TN951/2	39	13,5	1/2"	24
50	16		TN501/2	44	20	1/2"	22
50	16		TN503/4	45	20	3/4"	29

TN...

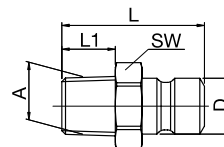

Wtyczka przedłużana 100 mm



Seria	S	Kod - z zaworem	Kod - bez zaworu	L	L1	A	SW
70	6		TN701/8/100	100	60	1/8"	11
70	6		TN701/4/100	100	60	1/4"	14
95	9		TN951/4/100	100	60	1/4"	14
95	9		TN953/8/100	100	60	3/8"	17

TN.../100

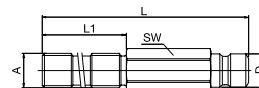

Wtyczka przedłużana



Seria	S	Kod - z zaworem	Kod - bez zaworu	L	L1	A	SW
70	6		TN7010/100	100	9	1/8"	11
70	6		TN7010/150	150	9	1/8"	11
70	6		TN7010/250	250	9	1/8"	11
95	9		TN9514/150	150	12	1/4"	15
95	9		TN9514/250	250	12	1/4"	15

TN.../...

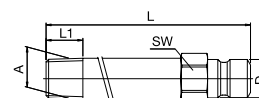

Wtyczka gwint, kątowna 90 stopni



Seria	S	Kod - z zaworem	Kod - bez zaworu	L	L2	A	SW
70	6		TNV701/8	27	28,5	1/8"	11
70	6		TNV70M10	27	28,5	M10 x 1	11
70	6		TNV701/4	27	28,5	1/4"	11
95	9		TNV951/4	34	32	1/4"	15
95	9		TNV953/8	34	32	3/8"	15

TNV...

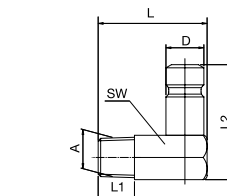

Wtyczka z tuleją do węża



Seria	S	Kod - z zaworem	Kod - bez zaworu	L	L1	A	D
70	6		TN7010	39	22	10 mm	9,5
95	9		TN9513	41	21	13 mm	13,5
50	16		TN5019	91	46	19 mm	20

TN...

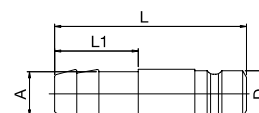

Wtyczka z gwintem wewnętrznym



Seria	S	Kod - z zaworem	Kod - bez zaworu	L	L1	A	SW
70	6		TNI701/8	28	11	1/8"	13
70	6		TNI701/4	32	13	1/4"	16
70	6		TNI703/8	34	13	3/8"	19
95	9		TNI951/4	37	13	1/4"	16
95	9		TNI953/8	39	13	3/8"	19

TNI...

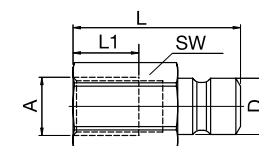

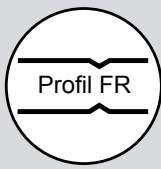

Szybkozłącza do form wtryskowych typ francuski - seria 80, 120

Wtyk z tuleją na wąż



Seria	S	Kod - bez zaworu	D	L	L1	A
80	8	TL8008	20	65	28	8 mm
80	8	TL8010	20	65	28	10 mm
80	8	TL8012	20	65	28	12 mm
120	12	TL12013	28	77	33	13 mm
120	12	TL12016	28	77	33	16 mm

TL...

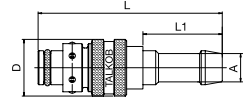

Wtyk z tuleją na wąż / 90 stopni



Seria	S	Kod - bez zaworu	D	L	L1	A
80	8	TV8010/90	20	51	20	10 mm
80	8	TV8012/90	20	51	20	12 mm
120	12	TV12013/90	28	59	25	13 mm
120	12	TV12016/90	28	62	25	16 mm

TV.../90

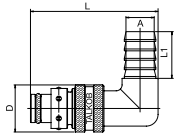

Wtyk z tuleją na wąż / 45 stopni



Seria	S	Kod - bez zaworu	D	L	L1	A
80	8	TV8010/45	20	51	20	10 mm
80	8	TV8012/45	20	51	20	12 mm
120	12	TV12013/45	28	55	25	13 mm
120	12	TV12016/45	28	55	25	16 mm

TV.../45

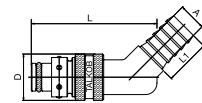

Wtyk z gwintem wewnętrznym



Seria	S	Kod - bez zaworu	D	L	L1	SW	A
80	8	TI801/4	20	54	10	17	1/4"

TI...

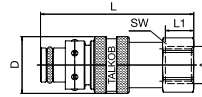

Gniazdo z gwintem zewnętrznym



Seria	S	Kod - bez zaworu	D	L	L1	SW	A
80	8	TN801/8	21	32	10	6	1/8"
80	8	TN80M10	21	32	10	6	M10 x 1
80	8	TN801/4	21	33	12	8	1/4"
80	8	TN803/8	21	24	13	8	3/8"
120	12	TN1203/8	32	41	13	10	3/8"
120	12	TN1201/2	32	44	16	14	1/2"
120	12	TN1203/4	32	32	19	14	3/4"

TN...

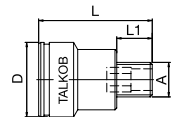

Gniazdo z gwintem wewnętrznym



Seria	S	Kod - bez zaworu	D	L	L1	SW	A
80	8	TNI801/8	21	35	10	6	1/8"
80	8	TNI801/4	21	40	14	8	1/4"
120	12	TNI1203/8	32	49	14	12	3/8"
120	12	TNI1201/2	32	50	14	12	1/2"

TNI...

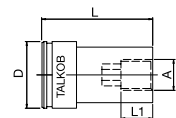

Gniazdo z gwintem zew. / 90 stopni



Seria	S	Kod - bez zaworu	D	L	L1	L2	A
80	8	TNV801/8/90	22	34	11	33	1/8"
80	8	TNV801/4/90	22	37	13	33	1/4"
80	8	TNV803/8/90	22	37	13	33	3/8"

TNV.../90

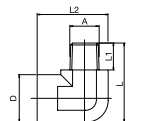

Gniazdo z gwintem zew. / 45 stopni



Seria	S	Kod - bez zaworu	D	L	L1	A
80	8	TNV801/8/45	22	33	10,5	1/8"
80	8	TNV801/4/45	22	35	13	1/4"

TNV.../45

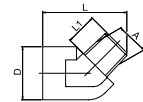

Gniazdo z gwintem przedłużonym



Seria	S	Kod - bez zaworu	D	L	L1	SW	A
80	6	TN801/8/50	21	50	28	6	1/8"
80	6	TN801/8/100	21	100	60	6	1/8"
80	6	TN801/8/150	21	150	60	6	1/8"
80	8	TN801/4/50	21	50	28	8	1/4"
80	8	TN801/4/100	21	100	60	8	1/4"
80	8	TN801/4/150	21	150	60	8	1/4"
80	8	TN801/4/200	21	200	60	8	1/4"

TN.../...

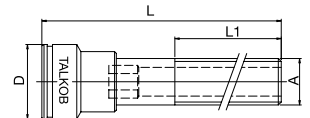

Kolorowy ring do gniazda i wtyku

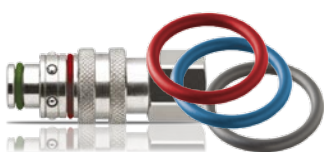

Seria	Ring do wtyku	Kolor	Seria	Ring do gniazda	Kolor
80	TMC80R	czerwony	80	TMN80R	czerwony
80	TMC80B	niebieski	80	TMN80B	niebieski
80	TMC80S	czarny	80	TMN80S	czarny
120	TMC120R	czerwony	120	TMN120R	czerwony
120	TMC120B	niebieski	120	TMN120B	niebieski
120	TMC120S	czarny	120	TMN120S	czarny

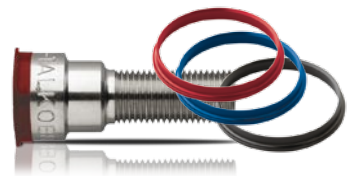

Szybkozłącza do form wtryskowych

typ francuski - seria 9, 12, 16



Gniazdo z tuleją na wąż



Seria	DN	Przyłącze	Kod - z zaworem	Kod - bez zaworu	D	L	L1	A
9	9	12 mm	TL912		24	71	25	12
12	12	16 mm	TL1216		32	90,5	32	16
16	16	19 mm	TL1619		38	112,5	36	19

TL...

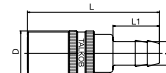

Gniazdo z tuleją na wąż / 90 st.



Seria	DN	Przyłącze	Kod - z zaworem	Kod - bez zaworu	D	L	L1	A
9	9	10 mm	TV910/90		24	60,5	22	10
9	9	12 mm	TV912/90		24	60,5	28,5	12

TV...

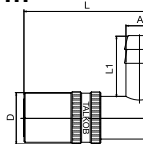

Gniazdo z gwintem zewnętrznym



Seria	DN	Przyłącze	Kod - z zaworem	Kod - bez zaworu	D	L	L1	A
9	9	3/8	TU93/8		24	61	6	G3/8
12	12	1/2	TU121/2		32	74,5	12	G1/2
16	16	3/4	TU163/4		38	90,5	16	G3/4

TU...

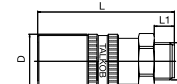

Gniazdo z gwintem wewnętrznym



Seria	DN	Przyłącze	Kod - z zaworem	Kod - bez zaworu	D	L	L1	A
9	9	3/8	TI93/8		24	56	10	G3/8
12	12	1/2	TI121/2		32	59,5	12	G1/2
16	16	3/4	TI163/4		38	90,5	16	G3/4

TI...

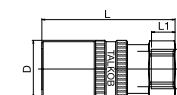

Wtyk z gwintem zewnętrznym



Seria	DN	Przyłącze	Kod - z zaworem	Kod - bez zaworu	D	L	L1	SW	A
9	9	1/2		TN91/2	13,8	37	12	22	G1/2BSP
12	12	1/2		TN121/2	17,8	42	17	22	R1/2BSPT
12	12	3/4		TN123/4	17,8	46	16	27	G3/4BSP
16	16	3/4		TN163/4	22,4	59	19	27	R3/4BSPT

TN...

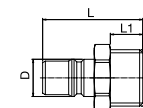
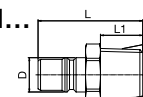

Wtyk z gwintem zewnętrznym



Seria	DN	Przyłącze	Kod - z zaworem	Kod - bez zaworu	D	L	L1	SW	A
9	9	1/4		TN91/4	13,8	35	12	8	R1/4BSPT
9	9	3/8		TN93/8	13,8	35	12	8	R3/8BSPT
12	12	3/8		TN123/8	17,8	40	12	10	R3/8BSPT

TN...

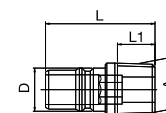

Wtyk z gwintem zewnętrznym



Seria	DN	Przyłącze	Kod - z zaworem	Kod - bez zaworu	D	L	L1	SW	A
9	9	1/4		TN91/4V	13,8	49	9	19	G1/4BSP
9	9	3/8		TN93/8V	13,8	47	9	24	G3/8BSP
9	9	1/2		TN91/2V	13,8	50	12	27	G1/2BSP
9	9	1/2		TN91/2V-S	13,8	37	12	22	R1/2BSPT
12	12	3/8		TN123/8V	17,8	61	9	24	G3/8BSP
12	12	1/2		TN121/2V	17,8	62	12	27	G1/2BSP
12	12	3/4		TN123/4V	17,8	64	16	34	G3/4BSP
12	12	3/4		TN123/4V-S	17,8	46	16	27	R3/4BSPT
16	16	3/4		TN163/4V	22,4	81	16	34	G3/4BSP
16	16	1		TN161/1V	22,4	84	19	41	G1BSP
16	16	1		TN161/1V-S	22,4	58	20	32	R1BSPT

TN...V

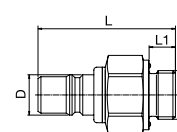

Wtyk z gwintem wewnętrznym



Seria	DN	Przyłącze	Kod - z zaworem	Kod - bez zaworu	D	L	L1	SW	A
9	9	3/8		TNI93/8	13,8	37	10	22	G3/8BSP
12	12	1/2		TNI121/2	17,8	45	12	27	G1/2BSP
16	16	3/4		TNI163/4	22,4	58	16	32	G3/4BSP

TNI...

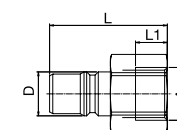

Wtyk z gwintem wewnętrznym



Seria	DN	Przyłącze	Kod - z zaworem	Kod - bez zaworu	D	L	L1	SW	A
9	9	1/4		TNI91/4V	13,8	46	10	19	G1/4BSP
9	9	3/8		TNI93/8V	13,8	48	10	22	G3/8BSP
16	16	3/4		TNI163/4V	22,4	80,5	16	32	G3/4BSP

TNI...V

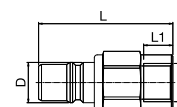

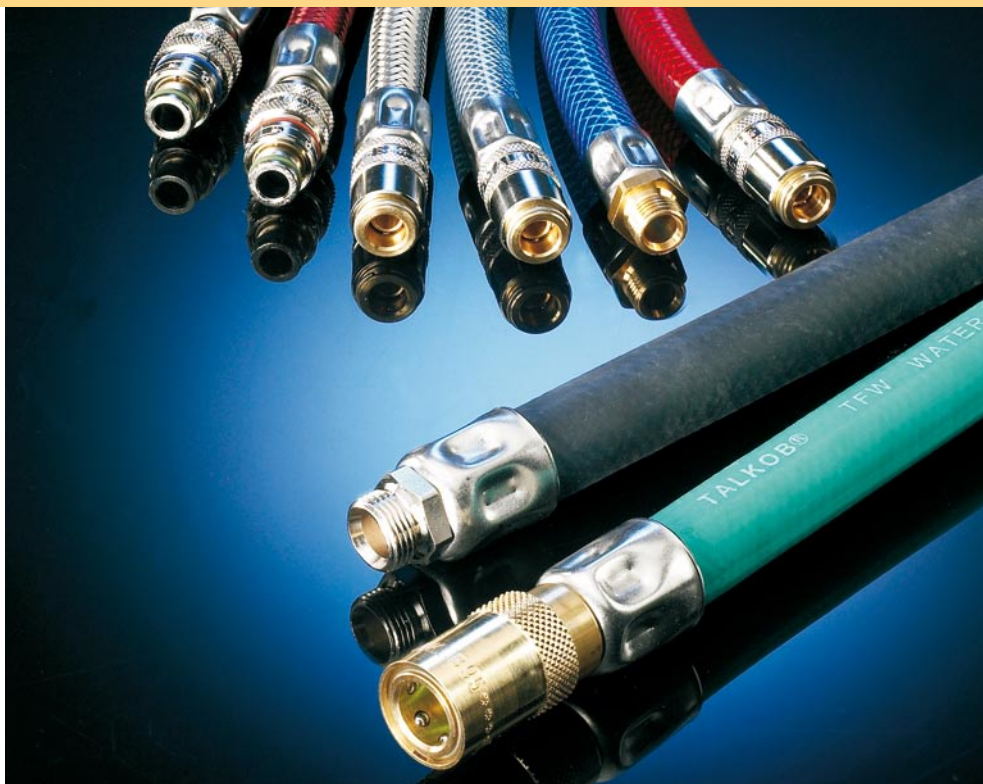

STRUKTURA KODU PRZEWODÓW OKUTYCH

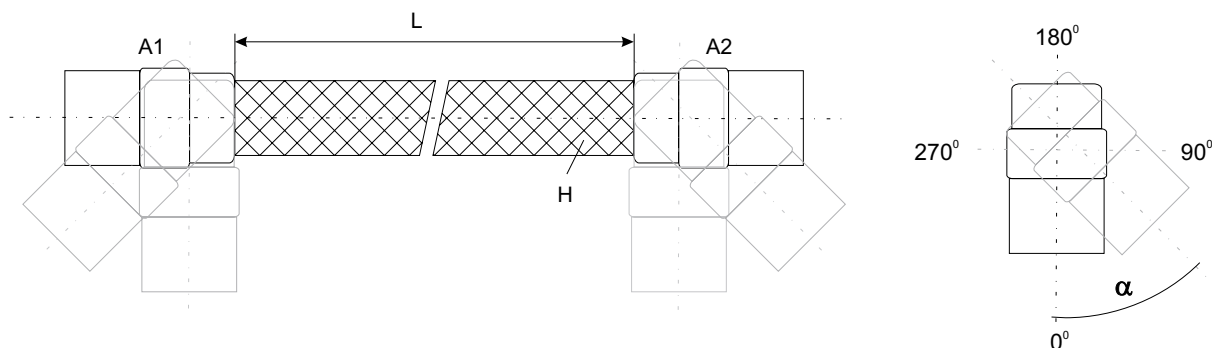

H - L - A1 - A2 - α

H – kod przewodu (EPDM, NBR, PVC, SILIKON, VITON)

L – długość przewodu

A1 – kod rodzaju złącza A1 (tuleja gwint wewnętrzny, zewnętrzny, tuleja do węża, szybkozłącze, wtyczka)

A2 – kod rodzaju złącza A2 (tuleja gwint wewnętrzny, zewnętrzny, tuleja do węża, szybkozłącze, wtyczka)

α – kąt położenia dwóch szybkozłączy kątowych względem siebie (złącze A1 na pierwszym planie, złącze A2 na drugim planie)

Przykład

TFW13B - L1000 - TL9013 - TN9013 :

Przewód EPDM DN13 długość 1000 mm okuty w szybkozłącze TL9013 i wtyczkę TN9013.

TFP19T - L1500 - TV2019/45 - TV2019/90 - 45 :

Przewód PVC DN19 długość 1500 mm okuty w szybkozłącze TV2019/45 z jednej strony i szybkozłącze TV2019/90 z drugiej strony. Szybkozłącze TV2019/90 jest przesunięte względem szybkozłącza TV2019/45 o 45 stopni.

Przewody



- przewód do wody



- przewód do oleju



- odporność temperaturowa

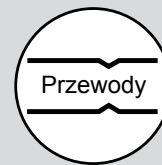

TFW - Przewody EPDM

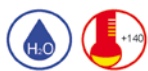

Kod	D1	D	L	Kolor	Kod tulejki
TFW10B	10/9	17,5	50 m	niebieski	TFK1810
TFW10R	10/9	17,5	50 m	czerwony	TFK1810
TFW10S	10/9	17,5	50 m	czarny	TFK1810
TFW13B	13	21	50 m	niebieski	TFK2313
TFW13R	13	21	50 m	czerwony	TFK2313
TFW13S	13	21	50 m	czarny	TFK2313
TFW19S	19	27	30 m	czarny	TFK2919

TFW...

ciśnienie robocze
max. 15 bar

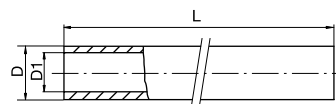

TFO - Przewody NBR



Kod	D1	D	L	Kolor	Kod tulejki
TFO10S	10/9	17,5	50 m	czarny	TFK1810
TFO13S	13	21	50 m	czarny	TFK2313

TFO...

ciśnienie robocze
max. 15 bar

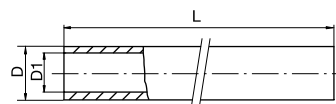

TFP - Przewody PVC

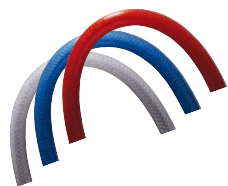

Kod	D1	D	L	Kolor	Kod tulejki
TFP10T	10/9	16	50 m	przezroczysty	TFK1610
TFP10B	10/9	16	50 m	niebieski	TFK1610
TFP10R	10/9	16	50 m	czerwony	TFK1610
TFP13T	13	21	50 m	przezroczysty	TFK1913
TFP13B	13	21	50 m	niebieski	TFK1913
TFP13R	13	21	50 m	czerwony	TFK1913
TFP19T	19	27	25 m	przezroczysty	TFK2919

TFP...

ciśnienie robocze
max. 15 bar

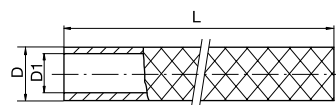

TFS - Przewody silikonowe



Kod	D1	D	L	Kolor	Kod tulejki
TFS10	10/9	16	25 m	srebrny	TFK1610
TFS10B	10/9	16	25 m	niebieski	TFK1610
TFS10R	10/9	16	25 m	czerwony	TFK1610
TFS13	13	19	25 m	srebrny	TFK1913
TFS13B	13	19	25 m	niebieski	TFK1913
TFS13R	13	19	25 m	czerwony	TFK1913

TFS...

ciśnienie robocze
max. 15 bar

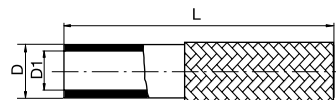

TFKM - Przewody Viton



Kod	D1	D	L	Kolor	Kod tulejki
TFKM10	9	16	25 m	srebrny	TFK1610
TFKM10B	9	16	25 m	niebieski	TFK1610
TFKM10R	9	16	25 m	czerwony	TFK1610
TFKM13	13	19	25 m	srebrny	TFK1913
TFKM13B	13	19	25 m	niebieski	TFK1913
TFKM13R	13	19	25 m	czerwony	TFK1913

TFKM...

ciśnienie robocze
max. 15 bar

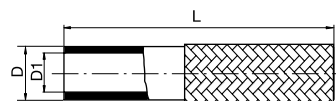



TFK - Tulejka zaciskowa do węży wykonana ze stali nierdzewnej



Kod	d	D			
TFK1610	10	16			
TFK1810	10	18			
TFK1913	13	19			
TFK2013	13	20			
TFK2313	13	23			
TFK2919	19	29			

TFK...

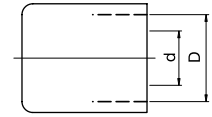

Kod	D		
TFP 1000	średnice od 10 - 36 mm		

TFP...

Urządzenie TFP 100 służy do ręcznego zaciskania tulejek typu TFK na przewodach niskociśnieniowych w zakresie średnic zewnętrznych od 10 do 36 mm

Opaska typu NORMA



Kod	D	d			
TFB0814	8-12	8			
TFB1016	10-17	10			
TFB1318	12-22	13			
TFB2232	22-32	19			

TFB...

Tuleja do węży, gwint zewnętrzny

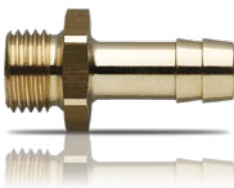

Kod	A	D	L	L1	SW
TFM810	M8 x 0,75	9 mm	33,5	7	11
TFM1010	M10 x 1	9 mm	33,5	7	11
TF1/810	1/8"	9 mm	33	7	14
TF1/410	1/4"	10 mm	35	9	17
TFM1213	M12 x 1,5	13 mm	40	9	15
TF1/413	1/4"	13 mm	42	9	17
TFM1413	M14 x 1,5	13 mm	43	10	17
TFM1613	M16 x 1,5	13 mm	40	9	17
TF3/813	3/8"	13 mm	42	9	19
TFM2419	M24 x 1,5	19 mm	56	16	27
TF1/219	1/2"	19 mm	54	12	24
TF3/419	3/4"	19 mm	60	16	32

TF...

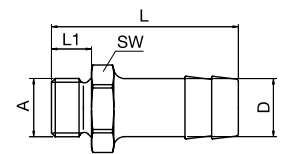

Tuleja do węży, gwint wewnętrzny



Kod	A	D	L	L1	SW
TFI1/810	1/8"	10 mm	33	8	14
TFI1/410	1/4"	10 mm	33	8	17
TFIM1410	M14 x 1,5	10 mm	32	10	17
TFI1/413	1/4"	13 mm	39	8	17
TFIM1613	M16 x 1,5	13 mm	40	10,5	22
TFI3/813	3/8"	13 mm	40	8	19

TFI...

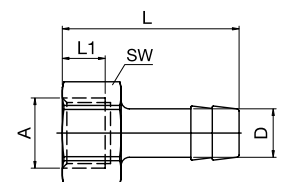

Tuleja do węża z nakrętką obrotową



Kod	A	D	L	L1	SW
TFC14	M14 x 1,5	9	39,5	22	17
TFC1/4	G 1/4	9	39,5	22	17
TFC16	M16 x 1,5	13	39	25	22
TFC3/8	G 3/8	13	39	25	22
TFC1/2	G 1/2	13	45	25	24
TFC24	M24 x 1,5	19	52	32	30
TFC3/4	G 3/4	19	52	32	32

TFC...

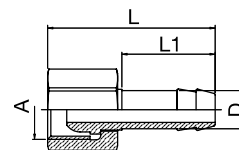

Kolanko do węża, gwint zewnętrzny



Kod	A	D	L	L1	SW
TFVM810	M8 x 0,75	10 mm	27	9	11
TFVM1010	M10 x 1	10 mm	27	9	11
TFV1/810	1/8"	10 mm	27	9	11
TFV1/410	1/4"	10 mm	34	11	15
TFV1/413	1/4"	13 mm	34	11	15
TFVM1413	M14 x 1,5	13 mm	34	11	15
TFV3/813	3/8"	13 mm	35	12	17
TFVM2419	M24 x 1,5	19 mm	47	16	24
TFV1/219	1/2"	19 mm	47	16	24

TFV...

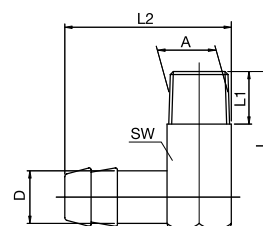

Łącznik gwint zewnętrzny



Kod	A	A1	L	L1	L2	SW
TFD14	M14 x 1,5	M14 x 1,5	23	9	9	17
TFD14-1/4	M14 x 1,5	G 1/4	23	9	9	17
TFD1/4	G 1/4	G 1/4	23	9	9	17
TFD16	M16 x 1,5	M16 x 1,5	23	9	9	19
TFD16-3/8	M16 x 1,5	G 3/8	23	9	9	19
TFD3/8	G 3/8	G 3/8	23	9	9	19
TFD1/2-14	G 1/2	M14 x 1,5	27	12	9	22
TFD1/2-16	G 1/2	M16 x 1,5	27	12	9	22
TFD1/2	G 1/2	G 1/2	30	12	12	22
TFD24-1/2	M24 x 1,5	G 1/2	36	16	12	27
TFD3/4	G 3/4	G 3/4	40	16	16	27
TFD3/4-24	G 3/4	M24 x 1,5	40	16	16	27

TFD...

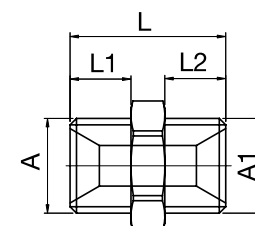

Redukcja krótka



Kod	A	A1	L	L1	SW
TF1/4-1/8	G 1/4	G 1/8	11	7	17
TF14-10	M14 x 1,5	M10 x 1	11	7	17
TF3/8-1/4	G 3/8	G 1/4	13	9	19
TF18-14	M18 x 1,5	M14 x 1,5	14	9	22
TF1/2-3/8	G 1/2	G 3/8	18	12	24
TF3/7-1/2	G 3/4	G 1/2	24	16	27
TF24-16	M24 x 1/5	M16 x 1,5	24	16	27

TF...

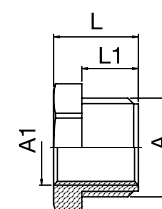

Korek stożkowy / cylindryczny



Kod - stoż.	Kod - cyl.	A	L	SW
TFRM8	TFRM8C	M8 x 0,75	8	4
TFRM10	TFRM10C	M10 x 1	8	5
TFR1/8	TFR1/8C	1/8"	8	5
TFRM12	TFRM12C	M12 x 1,5	8	6
TFR1/4	TFR1/4C	1/4"	10	7
TFRM14	TFRM14C	M14 x 1,5	10	7
TFR3/8	TFR3/8C	3/8"	10	8
TFR1/2	TFR1/2C	1/2"	10	10

TFR.../C

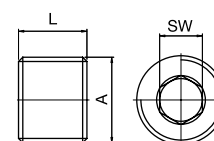



Korek z kołnierzem z gwintem cylindrycznym



Kod	A	D	L	L1	SW
TFLM10	M10 x 1	14	11	8	5
TFLR1/8	G 1/8	14	11	8	5
TFLM12	M12 x 1,5	17	15	12	6
TFLR1/4	G 1/4	18	15	12	6
TFLM14	M14 x 1,5	19	15	12	6
TFLR3/8	G 3/8	22	15	12	8
TFLR1/2	G 1/2	26	18	14	10

TFL...

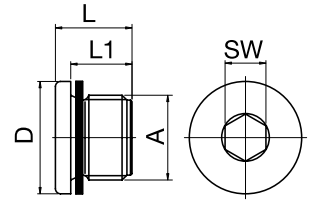

Korek

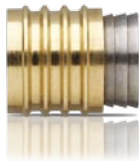

Kod	A	D	L	L1
TFVS6	M3	6	11,5	3,5
TFVS8	M4	8	11,5	3,5
TFVS10	M6	10	14	4
TFVS12	M6	12	14	4
TFVS16	M8	16	16	4

TFVS...

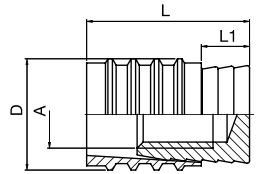

Przedłużka z tuleją do węża



Kod	D	D1	d	L	SW
TF10/120	10 mm	10	6	120 mm	11
TF10/240	10 mm	10	8	240 mm	11
TF13/150	13 mm	14	9	150 mm	15
TF13/300	13 mm	14	9	300 mm	15

TF...

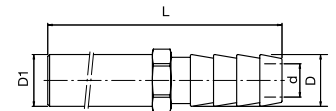

Przedłużka dwustronnie gwintowana



Kod	A	d	L
TF1/8/50	R1/8"	6	50 mm
TF1/8/100	R1/8"	6	100 mm
TF1/8/150	R1/8"	6	150 mm
TF1/8/200	R1/8"	6	200 mm
TF1/4/50	R1/4"	9	50 mm
TF1/4/100	R1/4"	9	100 mm
TF1/4/150	R1/4"	9	150 mm
TF1/4/200	R1/4"	9	200 mm
TF3/8/100	R3/8"	12	100 mm
TF3/8/150	R3/8"	12	150 mm
TF3/8/200	R3/8"	12	200 mm

TF...

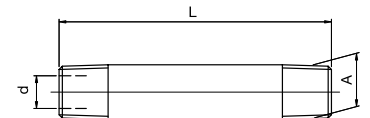

Kolektor

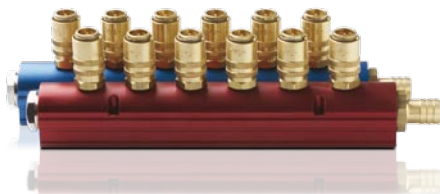

Kod	Kolor	Porty szt.	A	D2	S	H	D	L
TM4B	niebieski	4	G1/4"	G3/4"	43,2	43,0	114,3	190,5
TM4R	czerwony	4	G1/4"	G3/4"	43,2	43,0	114,3	190,5
TM6B	niebieski	6	G1/4"	G3/4"	43,2	43,0	190,5	266,7
TM6R	czerwony	6	G1/4"	G3/4"	43,2	43,0	190,5	266,7
TM8B	niebieski	8	G1/4"	G3/4"	43,2	43,0	266,7	342,9
TM8R	czerwony	8	G1/4"	G3/4"	43,2	43,0	266,7	342,9
TM4-2B	niebieski	4	G3/8"	G1"	55,9	54,1	152,4	228,6
TM4-2R	czerwony	4	G3/8"	G1"	55,9	54,1	152,4	228,6
TM6-2B	niebieski	6	G3/8"	G1"	55,9	54,1	254,0	330,2
TM6-2R	czerwony	6	G3/8"	G1"	55,9	54,1	254,0	330,2
TM8-2B	niebieski	8	G3/8"	G1"	55,9	54,1	355,6	431,8
TM8-2R	czerwony	8	G3/8"	G1"	55,9	54,1	355,6	431,8

TM...

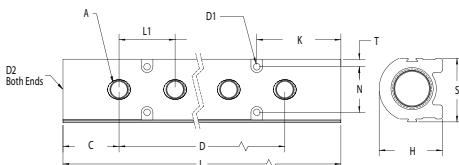

Płyta gniazdowa



Ilość zł.	Kod z zaworami	Kod bez zaw.	Przyłącze	A	B	C	TMM...K
8	TMM8K11/2V	TMM8K11/2	1/2" w.	170	100	50	
8	TMM8KS10V	TMM8KS10	9 mm	170	100	50	
8	TMM8KS13V	TMM8KS13	13 mm	170	100	50	

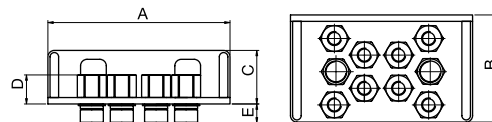

Płyta wtykowa



Ilość zł.	Kod z zaworami	Kod bez zaw.	Przyłącze	A	B	C	TMM...N
8	TMM8N11/2V	TMM8N11/2	1/2" w.	170	100	50	
8	TMM8NS10V	TMM8NS10	9 mm	170	100	50	
8	TMM8NS13V	TMM8NS13	13 mm	170	100	50	

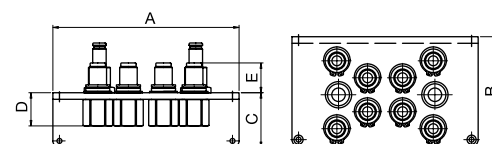

Dane techniczne:

Temperatura pracy	- 40°C do + 200°C zależnie od uszczelnienia
Uszczelnienia	Viton (opcje: Perbunan, EPDM, Kalrez)
Ciśnienie robocze	max. 15 bar
Materiały:	
płyty	aluminiowe
szybkozłącza	mosiądz i stal nierdzewna



Jesteśmy Waszym międzynarodowym partnerem w szybkim łączeniu wszelkiego rodzaju mediów. Szybkozłącza firmy RECTUS, szybkozłącza hydrauliczne TEMA oraz przewody NYCOIL oferują indywidualne rozwiązania problemów poprzez innowacyjną technologię. Aby zapoznać się z naszą pełną ofertą na Wasze życzenie prześlemy nasz generalny katalog.

RECTUS  **POLSKA**

Top connections – best solutions!

RECTUS Polska Sp. z o.o.
43-426 Dębowiec, Gumna 96
Tel. +48 33 857-98-00, +48 33 857-98-10
Fax. +48 33 857-98-08
rectus@rectus.pl www.rectus.pl