

04 Series

Regulators - Pressure Reducing

D04XX1792X012

Specifications

For other materials or modifications, please consult TESCOM.

OPERATING PARAMETERS

Pressure rating per criteria of ANSI/ASME B31.3

Maximum Inlet Pressure

3500 psig / 241 bar

Outlet Pressure Ranges

0-30, 0-60, 0-100 psig
0-2.1, 0-4.1, 0-6.9 bar

Design Proof Pressure

150% of maximum rated

Leakage

Internal: Bubble-tight

External: $< 1 \times 10^{-6}$ atm cc/sec He

Operating Temperature¹

-40°F to 165°F / -40°C to 74°C

Flow Capacity

$C_v = 0.06$

Maximum Operating Torque

30 in-lbs / 3.4 N•m

Decaying Inlet Characteristic

1.0 Change: 100 psig / 6.9 bar



TESCOM 04 Series space saving and lightweight miniature regulator offers minimal internal volume and is easy to purge resulting in less retention.

MEDIA CONTACT MATERIALS

Body

316 Stainless Steel, Brass or Aluminum

Diaphragm

Elgiloy®

Seat

CTFE¹, Teflon® or Vespel®

Friction Sleeve (inner)

Teflon®

Remaining Parts

316 Stainless Steel or Brass (on Brass models)

OTHER

Cleaning

CGA 4.1 and ASTM G93

Connections

1/8" or 1/4" NPTF

Internal Volume

3.03 cc

Weight (without gauges)

Stainless or Brass Models: 1 lb / 0.5 kg

Aluminum Models: 0.5 lb / 0.2 kg

Teflon® and Vespel® are registered trademarks of E.I du Pont de Nemours and Company.

Elgiloy® is a registered trademark of Elgiloy Corp.

1. CTFE option: maximum temperature of 140°F / 60°C

Applications

- Analyzers
- Lecture bottles
- Sampling systems

Features and Benefits

- Compact size (3" / 76 mm high) and constructed with lightweight materials
- Available in 316 Stainless Steel, Brass, or Aluminum body construction
- Elgiloy® diaphragm provides accurate and stable pressure control
- Minimal internal volume allows for rapid purging and carry-over
- Corrosion resistant
- Various porting configurations are available

04 Series Regulator Drawing

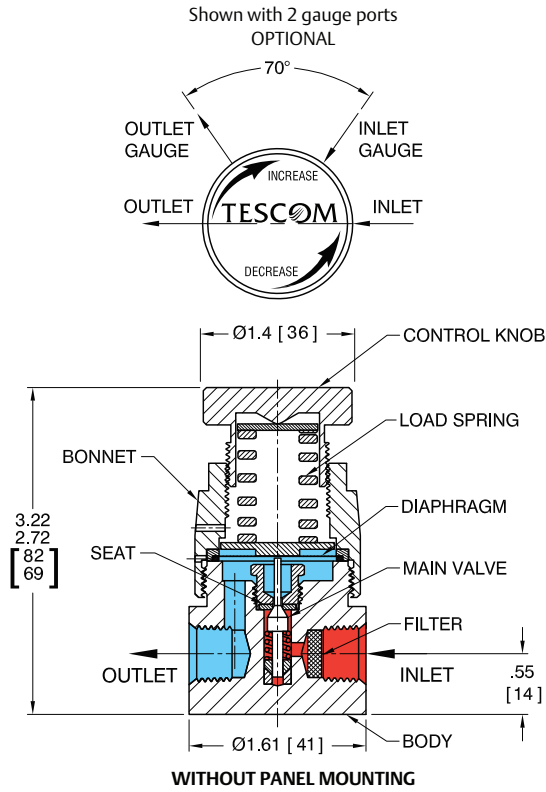

Required mounting hole for panel mounting

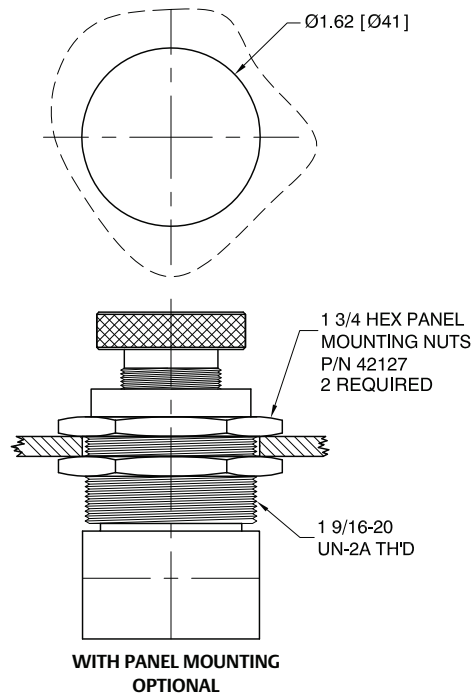

All dimensions are reference & nominal
Metric [millimeter] equivalents are in brackets

04 Series Regulator Flow Charts

For more information on how to read flow curves, please refer to the Flow Curves and Calculations document (debul2007x012) in the TESCOM catalog or on www.tescom.com.

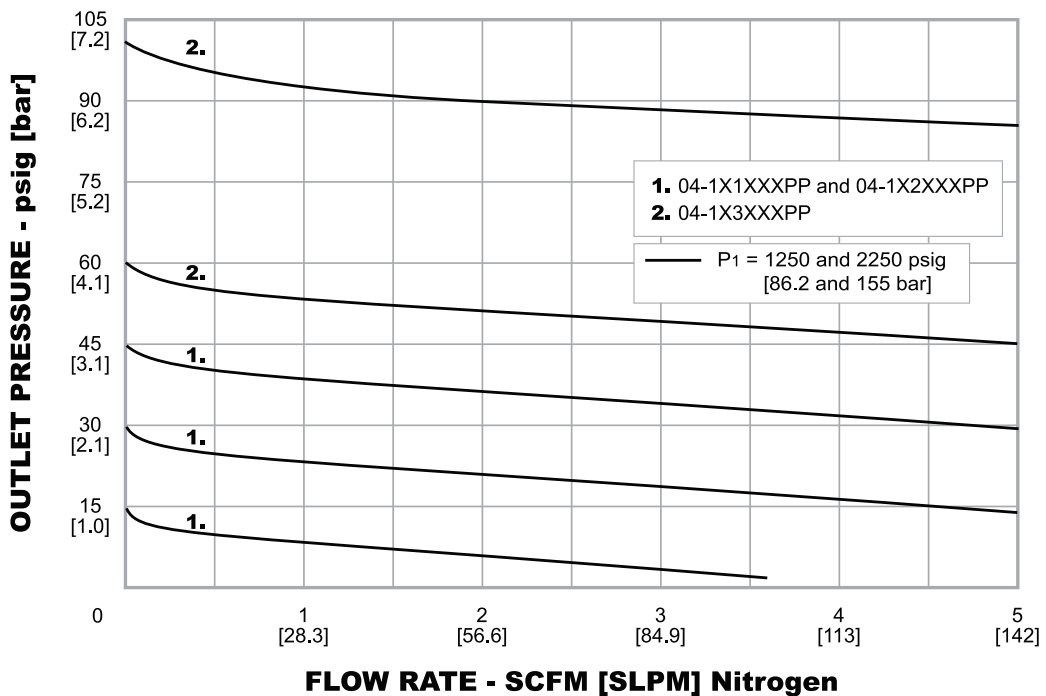
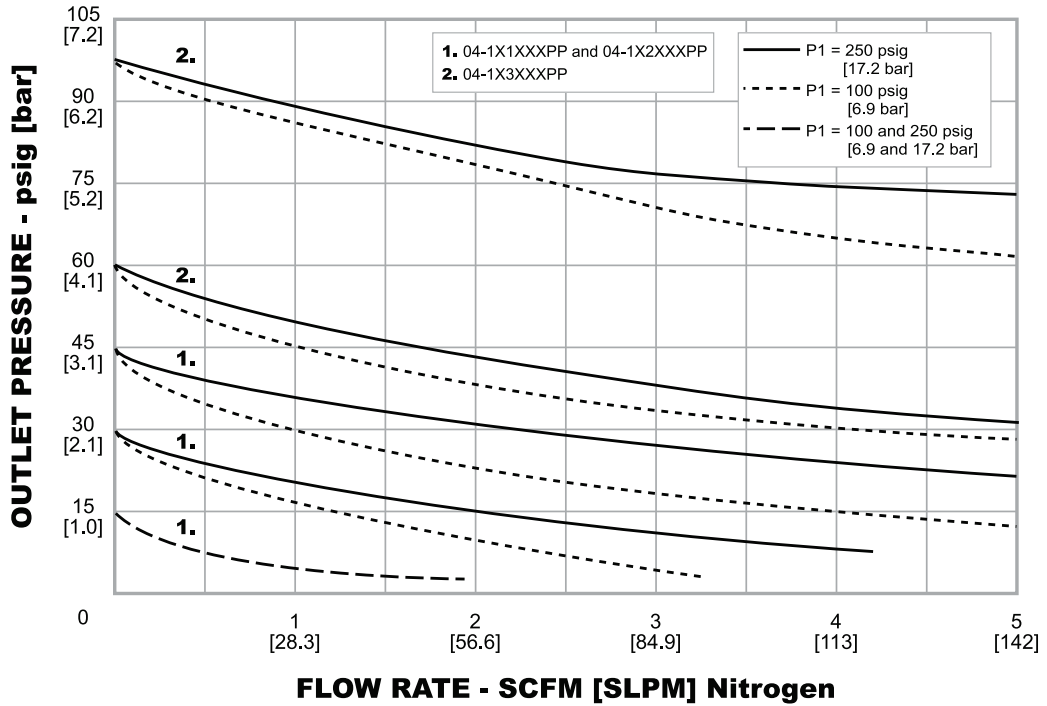

04 Series Regulator Part Number Selector

Repair Kits, Accessories & Modifications may be available for this product. Please contact TESCOM for more information.

Example for selecting a part number:

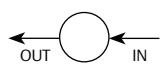
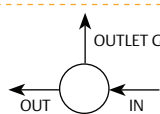
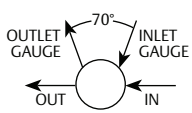
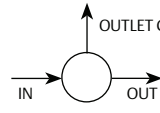
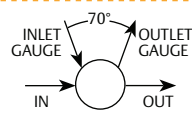
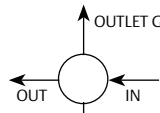
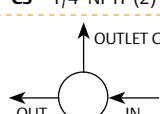
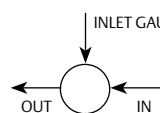
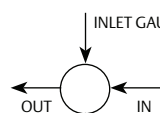
04-1	A	3	E	AA	PP	Z	
BASIC SERIES	INLET PRESSURE TRIM MATERIAL	BODY AND SEAT MATERIAL	OUTLET PRESSURE	ADJUSTMENT	GAUGE PORT OPTIONS SIZE, TYPE AND (NUMBER OF PORTS)	INLET AND OUTLET PORTS SIZE AND TYPE	OPTIONS
04-1	A – 3500 psig 241 bar 316 Stainless Steel	316/316L Stainless Steel Teflon®	1 – 0-30 psig 0-2.1 bar 2 – 0-60 psig 0-4.1 bar 3 – 0-100 psig 0-6.9 bar	Without Panel Mounting A – Black knob With Panel Mounting E – Black knob	 <p>AA – No Gauge Ports (0)</p>	PP – 1/8" NPTF NN – 1/4" NPTF	Z – None
					 <p>AF – 1/4" NPTF (1) AG – 1/8" NPTF (1)</p>		
	 <p>AT – 1/8" NPTF (2)</p>						
	 <p>BF – 1/4" NPTF (1) BG – 1/8" NPTF (1)</p>						
	 <p>BT – 1/8" NPTF (2)</p>						
	 <p>CS – 1/4" NPTF (2)</p>						
	 <p>DS – 1/4" NPTF (2)</p>						
	 <p>GF – 1/4" NPTF (2)</p>						
	 <p>GF – 1/4" NPTF (2)</p>						