

Specifications

For other materials or modifications, please consult TESCOM.

OPERATING PARAMETERS

Pressure rating per criteria of ANSI/ASME B31.3

Maximum Inlet Pressure

3500 psig / 241 bar

Outlet Pressure Ranges

0-30, 0-60, 0-100 psig

0-2.1, 0-4.1, 0-6.9 bar

Design Proof Pressure

150% of maximum rated

Leakage

Internal: Bubble-tight

External: $< 1 \times 10^{-6}$ atm cc/sec He

Operating Temperature¹

-40°F to 165°F / -40°C to 74°C

Flow Capacity

$C_V = 0.06$

Maximum Operating Torque

30 in-lbs / 3.4 N•m



TESCOM 04 Series space saving and lightweight miniature regulator offers minimal internal volume and is easy to purge resulting in less retention.

MEDIA CONTACT MATERIALS

Body

316 Stainless Steel, Brass or Aluminum

Diaphragm

Cobalt Chrome Nickel Alloy (Elgiloy®)

Seat

PCTFE¹, PTFE or Polyimide (VespeI®)

Friction Sleeve (inner)

PTFE

Remaining Parts

316 Stainless Steel or Brass (on Brass models)

OTHER

Cleaning

CGA 4.1 and ASTM G93

Connections

1/8" or 1/4" NPTF

Internal Volume

3.03 cc

Weight (without gauges)

Stainless or Brass Models: 1 lb / 0.5 kg

Aluminum Models: 0.5 lb / 0.2 kg

Teflon® and VespeI® are registered trademarks of E.I du Pont de Nemours and Company.

Elgiloy® is a registered trademark of Elgiloy Corp.

1. CTFE option: maximum temperature of 140°F / 60°C

Applications

- Analyzers
- Lecture bottles
- Sampling systems

Features and Benefits

- Compact size (3" / 76 mm high) and constructed with lightweight materials
- Available in 316 Stainless Steel, Brass, or Aluminum body construction
- Elgiloy® diaphragm provides accurate and stable pressure control
- Minimal internal volume allows for rapid purging and carry-over
- Corrosion resistant
- Various porting configurations are available

NOTE:

When choosing a regulator and control pressure, decaying inlet characteristic must be considered when the supply pressure is expected to change. The decaying inlet characteristic of a pressure reducing regulator is commonly known as the increase in control pressure due to the decrease in supply pressure. It is important to make sure this effect does not cause the control pressure to exceed the pressure rating of the unit's outlet or that of the downstream system.

For more information on decaying inlet, please refer to the Technical Information section of the product catalog and/or contact the TESCOM customer support further assistance.

04 Series Regulator Drawing

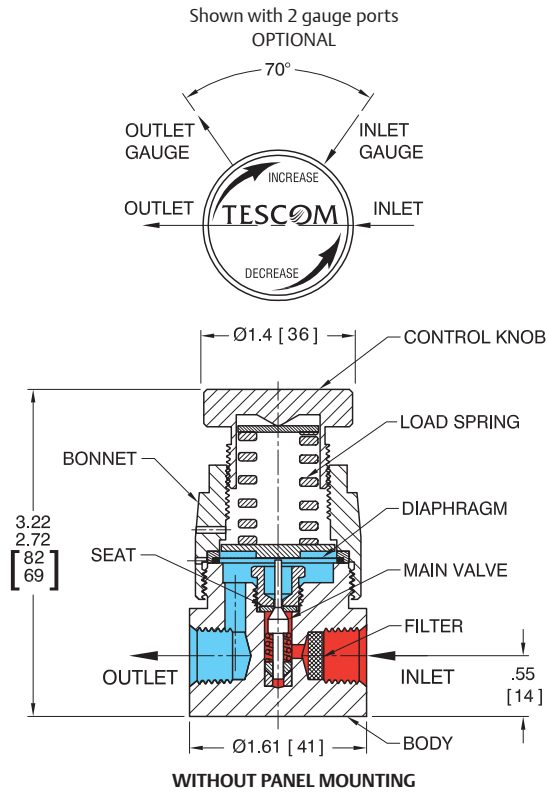

Required mounting hole for panel mounting

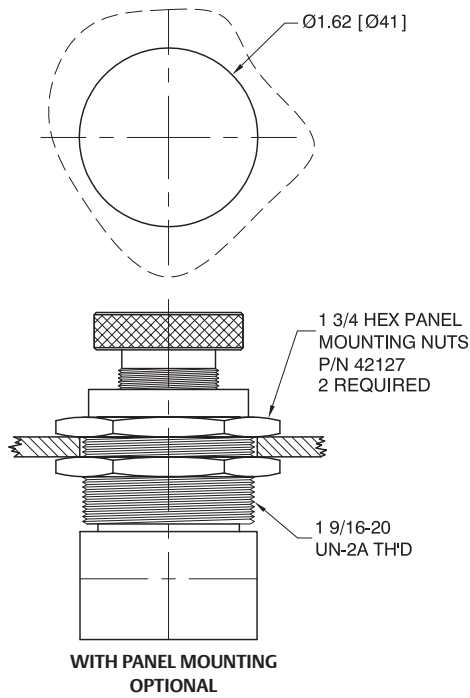

All dimensions are reference & nominal
Metric [millimeter] equivalents are in brackets

04 Series Regulator Flow Charts

For more information on how to read flow curves, please refer to the Flow Curves and Calculations document (debul2007x012) in the TESCO catalog or on www.tescom.com.

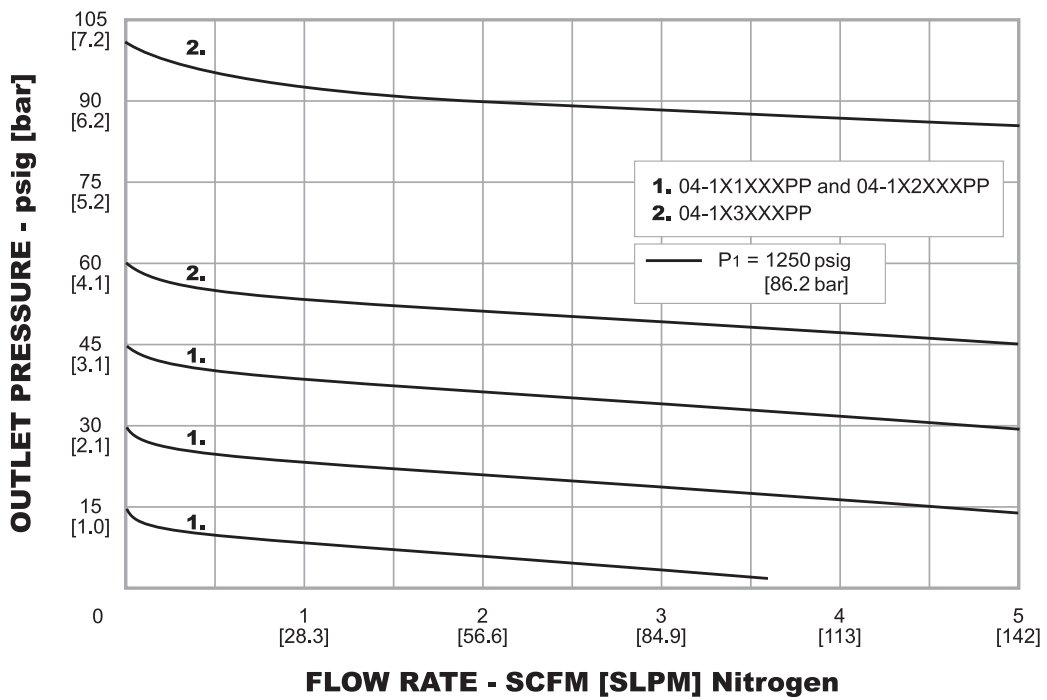
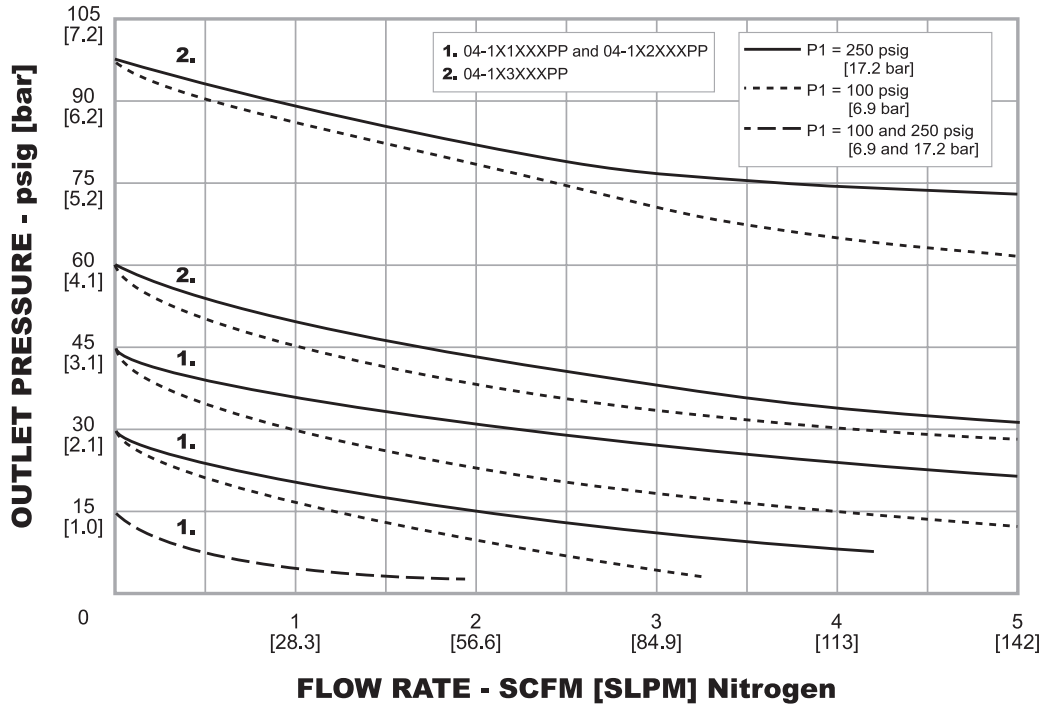

04 Series Regulator Part Number Selector

i Learn more about common options.
For modifications, repair kits and accessories, contact factory.

Example for selecting a part number:

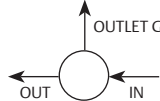
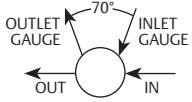
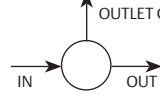
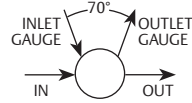
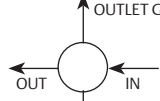
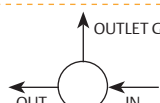
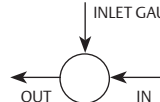
04-1	A	3	E	AA	PP	Z	
BASIC SERIES	INLET PRESSURE TRIM MATERIAL	BODY AND SEAT MATERIAL	OUTLET PRESSURE	ADJUSTMENT	GAUGE PORT OPTIONS SIZE, TYPE AND (NUMBER OF PORTS)	INLET AND OUTLET PORTS SIZE AND TYPE	OPTIONS
04-1	A – 3500 psig 241 bar 316 Stainless Steel	316/316L Stainless Steel PTFE	1 – 0-30 psig 0-2.1 bar 2 – 0-60 psig 0-4.1 bar	Without Panel Mounting A – Black knob With Panel Mounting E – Black knob	AA – No Gauge Ports (0) 	PP – 1/8" NPTF NN – 1/4" NPTF	Z – None
					AF – 1/4" NPTF (1) AG – 1/8" NPTF (1) 		
	B – 3500 psig 241 bar 316 Stainless Steel/Brass	Brass PTFE	3 – 0-100 psig 0-6.9 bar		AT – 1/8" NPTF (2) 		
					BF – 1/4" NPTF (1) BG – 1/8" NPTF (1) 		
	C – 3500 psig 241 bar 316 Stainless Steel/Brass	Aluminum PTFE			BT – 1/8" NPTF (2) 		
					CS – 1/4" NPTF (2) 		
	D – 3500 psig 241 bar 316 Stainless Steel	316/316L Stainless Steel PCTFE			DS – 1/4" NPTF (2) 		
					GF – 1/4" NPTF (2) 		
	E – 3500 psig 241 bar 316 Stainless Steel/Brass	Brass PCTFE					
F – 3500 psig 241 bar 316 Stainless Steel/Brass	Aluminum PCTFE						
G – 3500 psig 241 bar 316 Stainless Steel	316/316L Stainless Steel Polyimide (Vespel®)						
H – 3500 psig 241 bar 316 Stainless Steel/Brass	Brass Polyimide (Vespel®)						
J – 3500 psig 241 bar 316 Stainless Steel/Brass	Aluminum Polyimide (Vespel®)						