



We offer every industry standard size and grades But there is nothing 'standard' about the quality of our service

Established in 2001, Classic Filters Ltd. manufactures high-quality, bonded microfiber filter elements and filter housing for use in both gas and liquid applications.

Thanks to our highly-experienced team of engineers, we have developed some of the most efficient, low-cost filters, producing unparalleled flow rates and extremely low pressure drops.

Whether you need a filter element that's interchangeable with other manufacturers' filter housings, or whether you need a completely tailored, custom-built solution. We can deliver.

What's more, we can deliver quickly.

We appreciate the disruption and inconvenience that replacing a filter can cause, which is why we manufacture and deliver our products in super-quick time, to help minimise the impact that this has on your business.

We also offer local service and support to ensure that you get the best possible performance from your filtration system.

Why Choose Classic Filters?

- Low-cost, high-quality filtration solutions
- Extensive, customer-driven product range
- Super-quick logistics and delivery
- Customer service excellence
- Unparalleled support

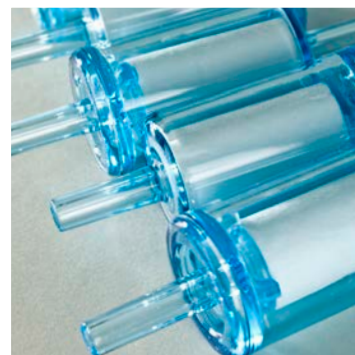

Take a look at our comprehensive product range to see if we have what you need to solve your filtration problems. If not, get in touch and we will make it for you, according to your particular specifications and requirements.

Introduction & Contents

CF/2.1/001	Introduction
CF/2.1/002	Contents: 1
CF/2.1/003	Contents: 2
CF/2.1/004	Contents: 3
CF/2.1/005	Contents: 4

Information & Applications

CF/2.1/006	Housing Advantages
CF/2.1/007	Particulate & Coalescing Filtration Explained
CF/2.1/007a	Stainless Steel Filter Housings
CF/2.1/008	Fast Loop & Bypass Filters
CF/2.1/009	PTFE-Membrane Housings
CF/2.1/010	PTFE-Membrane Housing Options
CF/2.1/011	Cyclone Filter Housings
CF/2.1/012	Catchpot & Bubbler Housings
CF/2.1/013	Drain Vessels for Coalescing Applications
CF/2.1/014	Automatic Float Drains for Coalescing Applications
CF/2.1/015	SBF Series Filter Housings with Flanges
CF/2.1/016	Heatable Housings for Hot Gas Analysis
CF/2.1/016a	Aluminium Filter Housings
CF/2.1/016b	Plastic Filter Housings
CF/2.1/017	Float Valve Housings for Automatic Flow Shut-Off
CF/2.1/018	SiS & SeS Series Filter Housings with Differential Pressure Indicators
CF/2.1/019	Sealing Options, Mounting Brackets and Support Cores
CF/2.1/020	How to Select the Correct Filter Housing

Filter Element Information

CF/2.1/020a	How to Select the Filter Element
CF/2.1/021	Disposable Type Particulate & Coalescing Filter Elements - Binders
CF/2.1/022	Disposable Type Particulate & Coalescing Filter Elements - Grades & Dimensions
CF/2.1/023	Stainless Steel Filter Elements
CF/2.1/023a	Stainless Steel Filter Discs and Single Layer Filter Elements
CF/2.1/023b	Stainless Steel Pleated Filter Elements
CF/2.1/024	PTFE & PE Filter Elements
CF/2.1/025	Ceramic Filter Elements
CF/2.1/026	LP Liquid Cartridges
CF/2.1/031	Air Flow Rates - Disposable Filter Elements
CF/2.1/032	Air Flow Rates - Stainless Steel Filter Elements
CF/2.1/033	Air Flow Rates - PTFE & PE Filter Elements
CF/2.1/034	Liquid Flow Rates - Stainless Steel Filter Elements

PTFE Membrane Information

CF/2.1/040	PTFE Membrane Information - Gas Separation and Liquid/Liquid Types
CF/2.1/041	Flow Rates - PTFE Membranes

Disposable In-Line Filters, Adsorbers and Cartridges

CF/2.1/050	DIF - Small Disposable In-Line Filters
CF/2.1/050a	DIF - Disposable In-Line Filters
CF/2.1/051	DIA - Small Disposable In-Line Adsorbers
CF/2.1/051a	DIA - Disposable In-Line Adsorbers
CF/2.1/052	Adsorption Cartridges for Housings
CF/2.1/053	Adsorber Columns for Granular Media
CF/2.1/053a	SS Adsorber Columns for Granular Media
CF/2.1/054	NN212.AD & NN232.AD - Adsorber Housing
CF/2.1/055	SS215.AD & SS235.AD - Adsorber Housing
CF/2.1/056	SS218.AD & SS238.AD - Adsorber Housing

Stainless Steel Filter Housings: SP76 Modular Sample System

	Housing Type	Material	Port Size	Pressure (Bar)	Element Size
CF/2.1/057	SH017 Series - SP76 Modular System	316L SS	SP76 Modular	350	10.32
CF/2.1/058	SH027 Series - SP76 Modular System	316L SS	SP76 Modular	350	10.57

Stainless Steel Filter Housings: 1/8" to 1/2" Line Sizes

	Housing Type	Material	Port Size	Pressure (Bar)	Element Size
CF/2.1/060	SG111 & SS112 Series	316L SS & Glass	1/8" & 1/4"	7 & 10	12.32
CF/2.1/061	SS117 Series	316L SS	1/8", 1/4" & 1/2"	350	12.32
CF/2.1/062	SV117 Series - Inverted Coalescing	316L SS	1/8" & 1/4"	350	12.32

Stainless Steel Filter Housings: 1/8" to 1/2" Line Sizes

	Housing Type	Material	Port Size	Pressure (Bar)	Element Size
CF/2.1/063	SS119 Series	316L SS	1/8" & 1/4"	700	12.32
CF/2.1/064	SG121 & SS122 Series	316L SS & Glass	1/8" & 1/4"	7 & 10	12.57
CF/2.1/065	SS127 Series	316L SS	1/8", 1/4" & 1/2"	350	12.57
CF/2.1/065a	SS127.MG - Filter Housing with Magnet	316L SS	1/8", 1/4" & 1/2"	350	12.32
CF/2.1/065b	SS125.F - Float Valve Housing	316L SS	1/8", 1/4" & 1/2"	100	-
CF/2.1/066	SV127 Series - Inverted Coalescing	316L SS	1/8" & 1/4"	350	12.57
CF/2.1/066a	SS147 Series	316L SS	1/8" & 1/4"	350	12.76
CF/2.1/067	SS129 Series	316L SS	1/8" & 1/4"	700	12.57
CF/2.1/067a	SS1210 Series	316L SS	1/4" & 3/8"	1050	12.57
CF/2.1/067b	SS1211 Series	316L SS	1/4" & 3/8"	1400	12.57
CF/2.1/068	SG211 & SS212 Series	316L SS & Glass	1/4" & 1/2"	7 & 10	25.64
CF/2.1/069	SS215 Series	316L SS	1/4" & 1/2"	100	25.64
CF/2.1/070	SiS215 Series with DPI	316L SS	1/4" & 1/2"	100	25.64
CF/2.1/071	SV215 Series - Inverted Coalescing	316L SS	1/4" & 1/2"	100	25.64
CF/2.1/072	SS216 Series	316L SS	1/4" & 1/2"	200	25.64
CF/2.1/073	SiS216 Series with DPI	316L SS	1/4" & 1/2"	200	25.64
CF/2.1/074	SS218 Series	316L SS	1/4" & 1/2"	400	25.64
CF/2.1/075	SiS218 Series with DPI	316L SS	1/4" & 1/2"	400	25.64
CF/2.1/076	SS219 Series	316L SS	1/4" & 1/2"	700	25.64
CF/2.1/077	SiS219 Series with DPI	316L SS	1/4" & 1/2"	700	25.64
CF/2.1/078	SG231 & SS232 Series	316L SS & Glass	1/4" & 1/2"	7 & 10	25.178
CF/2.1/079	SS225 Series	316L SS	1/4" & 1/2"	100	25.178
CF/2.1/080	SiS235 Series with DPI	316L SS	1/4" & 1/2"	100	25.178
CF/2.1/081	SV235 Series - Inverted Coalescing	316L SS	1/4" & 1/2"	100	25.178
CF/2.1/082	SS236 Series	316L SS	1/4" & 1/2"	200	25.178
CF/2.1/083	SiS236 Series with DPI	316L SS	1/4" & 1/2"	200	25.178
CF/2.1/084	SS238 Series	316L SS	1/4" & 1/2"	400	25.178
CF/2.1/085	SiS238 Series with DPI	316L SS	1/4" & 1/2"	400	25.178
CF/2.1/086	SS239 Series	316L SS	1/4" & 1/2"	700	25.178
CF/2.1/087	SiS239 Series with DPI	316L SS	1/4" & 1/2"	700	25.178

Stainless Steel Filter Housings: 3/4" to 1" Line Sizes

	Housing Type	Material	Port Size	Pressure (Bar)	Element Size
CF/2.1/088	SS325 Series	316L SS	3/4" & 1"	100	38.152
CF/2.1/089	SiS325 Series with DPI	316L SS	3/4" & 1"	100	38.152
CF/2.1/090	SS326 Series	316L SS	3/4" & 1"	200	38.152
CF/2.1/091	SiS326 Series with DPI	316L SS	3/4" & 1"	200	38.152
CF/2.1/091a	SS337 Series	316L SS	3/4" & 1"	350	38.178
CF/2.1/092	SS328 Series	316L SS	3/4" & 1"	400	38.152
CF/2.1/093	SiS328 Series with DPI	316L SS	3/4" & 1"	400	38.152

Stainless Steel Filter Housings: 3/4" to 2" Line Sizes

	Housing Type	Material	Port Size	Pressure (Bar)	Element Size
CF/2.1/094	SG421	316L SS & Glass	3/4" & 1"	7	51.230
CF/2.1/095	SS424 Series	316L SS	3/4" & 1"	35	51.230
CF/2.1/096	SS425 & SHS425 Series	316L SS	1" to 2"	100	51.230
CF/2.1/097	SS426 & SHS426 Series	316L SS	1" to 2"	200	51.230
CF/2.1/098	SS428 & SHS428 Series	316L SS	1" to 2"	400	51.230
CF/2.1/099	SS434 Series	316L SS	3/4" & 1"	35	51.476
CF/2.1/100	SS435 & SHS435 Series	316L SS	1" to 2"	100	51.476
CF/2.1/101	SS436 & SHS436 Series	316L SS	1" to 2"	200	51.476
CF/2.1/102	SS438 & SHS438 Series	316L SS	1" to 2"	400	51.476

Stainless Steel Heatable Filter Housings

	Housing Type	Material	Port Size	Pressure (Bar)	Element Size
CF/2.1/110	HST Series	316L SS	1/8" & 1/4"	7	12.32 to 25.178
CF/2.1/111	HRT Series	316L SS	1/4"	7	25.64 & 25.178
CF/2.1/112	HSS Series	316L SS	1/4"	7	25.64 & 25.178
CF/2.1/113	HRS Series	316L SS	1/4"	7	25.64 & 25.178

Stainless Steel Fast Loop, In-Line & End-of-Line Filter Housings

	Housing Type	Material	Port Size	Pressure (Bar)	Element Size
CF/2.1/114	SLD Series - In-Line Type	316L SS	1/8" & 1/4"	200	FD.13
CF/2.1/115	SF Series - Fast Loop (Bypass) Type	316L SS	1/4" & 1/2"	100 & 350	12.32 to 25.178
CF/2.1/116	SL Series - In-Line Type	316L SS	1/4" & 1/2"	100 & 350	12.32 to 25.178
CF/2.1/117	SE Series - End-of-Line Type	316L SS	1/4" & 1/2"	-	12.32 to 25.64
CF/2.1/118	SO Series - End-of-Line Type	316L SS	1/4" & 1/2"	-	12.32 to 25.178

Stainless Steel Drain Vessels

	Housing Type	Material	Port Size	Pressure (Bar)
CF/2.1/120	DN103 Series	316L SS & PA	1/8" & 1/4"	17
CF/2.1/121	DF105 Series	316L SS	1/8" to 1/2"	35
CF/2.1/130	DG111 & DS112 Series	316L SS & Glass	1/8" & 1/4"	7 & 10
CF/2.1/131	DG121 & DS122 Series	316L SS & Glass	1/8" & 1/4"	7 & 10
CF/2.1/131b	DS127 Series	316L SS	1/8" & 1/4"	350
CF/2.1/132	DG211 & DS212 Series	316L SS & Glass	1/8" & 1/4"	7 & 10
CF/2.1/133	DS215 Series	316L SS	1/4" & 1/2"	100
CF/2.1/134	DG231 & DS232 Series	316L SS & Glass	1/8" & 1/4"	7 & 10
CF/2.1/135	DS235 Series	316L SS	1/4" & 1/2"	100

Stainless Steel Differential Pressure Indicators

	Housing Type	Material	Pressure (Bar)
CF/2.1/139	SSDPI Series	316L SS	400-1050

Regulators & Filter Regulators

	Housing Type	Material	Port Size	Pressure (Bar)	Element Size
CF/2.1/140	RSP103 & RSS103 Series	316L SS	1/8" & 1/4"	17	-
CF/2.1/141	RSP113 Series	316L SS	1/8" & 1/4"	17	12.32
CF/2.1/142	RSS113 Series	316L SS	1/8" & 1/4"	17	12.32
CF/2.1/143	RSP123 Series	316L SS	1/8" & 1/4"	17	12.57
CF/2.1/144	RSS123 Series	316L SS	1/4" & 1/4"	17	12.57

PTFE-Membrane Housings: 1/8" to 1/2" Line Sizes

	Housing Type	Material	Port Size	Pressure (Bar)	Membrane Size
CF/2.1/148	FML101 Series	PTFE	1/4" Spigot	7	MT.33
CF/2.1/149	SM015 Series - SP76 Modular System	316L SS	SP76 Modular	100	MT.19
CF/2.1/150	SM015 Series	316L SS	1/16" & 1/8"	100	MT.19
CF/2.1/150a	GSM105 Series	316L SS	1/8" & 1/4"	100	MT.33
CF/2.1/150b	FM101 Series	PTFE	1/8" & 1/4"	7	MT.33
CF/2.1/151	SM106 Series	316L SS	1/8" & 1/4"	200	MT.33
CF/2.1/152	STM106 Series	316L SS	1/8" & 1/4"	200	2x MT.33
CF/2.1/152a	STCM106 Series	316L SS	1/8" & 1/4"	200	2x MT.47
CF/2.1/152b	FM201 Series	PTFE	1/4" & 1/2"	7	MT.61
CF/2.1/153	SM202 Series	316L SS	1/4" & 1/2"	10	MT.61
CF/2.1/154	SM206 Series	316L SS	1/4" & 1/2"	200	MT.61
CF/2.1/155	SMD206 Series	316L SS	1/4" & 1/2"	200	MT.61
CF/2.1/156	SML206 Series	316L SS	1/4" & 1/2"	200	MT.61
CF/2.1/157	SM304 Series	316L SS	1/8" & 1/4"	35	MT.89
CF/2.1/158	STM304 Series	316L SS	1/4" & 1/2"	35	2x MT.101
CF/2.1/159	SML304 Series	316L SS	1/4" & 1/2"	35	MT.89
CF/2.1/160	STML304 Series	316L SS	1/4" & 1/2"	35	2x MT.101
CF/2.1/162	FM111 Series - Combination Housing	PTFE	1/8" & 1/4"	7	MT.33
CF/2.1/163	SM115 Series - Combination Housing	316L SS	1/8" & 1/4"	100	12.32 & MT.33
CF/2.1/163a	FGM121 Series - Combination Housing	PTFE & Glass	1/8" & 1/4"	7	12.57 & MT.33
CF/2.1/163b	FM121 Series - Combination Housing	PTFE	1/8" & 1/4"	7	12.57 & MT.33
CF/2.1/164	SM125 Series - Combination Housing	316L SS	1/8" & 1/4"	100	12.57 & MT.33
CF/2.1/165	SM215 Series - Combination Housing	316L SS	1/4" & 1/2"	100	25.64 & MT.61
CF/2.1/166	SM235 Series - Combination Housing	316L SS	1/4" & 1/2"	100	25.178 & MT.61

Stainless Steel Cyclone Filter Housings

	Housing Type	Material	Port Size	Pressure (Bar)	Filter Disc Size
CF/2.1/169	STW106 Series	316L SS	1/8" & 1/4"	200	2x FD.33
CF/2.1/170	SW205 Series	316L SS	1/4" & 1/2"	100	FD.64
CF/2.1/171	STW406 Series	316L SS	1/4" & 1/2"	200	2x FD.101

Aluminium Filter Housings: 1/8" to 1/2" Line Sizes

	Housing Type	Material	Port Size	Pressure (Bar)	Element Size
CF/2.1/200	AN112 Series	AL & PA	1/8" & 1/4"	10	12.32
CF/2.1/201	AA113 Series	AL & PA	1/8" & 1/4"	17	12.32
CF/2.1/202	AN122 Series	AL & PA	1/8" & 1/4"	10	12.57
CF/2.1/203	AA123 Series	AL & PA	1/8" & 1/4"	17	12.57
CF/2.1/204	AN212 Series	AL & PA	1/4" & 1/2"	10	25.64
CF/2.1/205	AiN212 Series	AL & PA	1/4" & 1/2"	10	25.64
CF/2.1/206	AA213 Series	AL & PA	1/4" & 1/2"	17	25.64
CF/2.1/207	AiA213 Series	AL & PA	1/4" & 1/2"	17	25.64

Aluminium Filter Housings: 1/8" to 1/2" Line Sizes

	Housing Type	Material	Port Size	Pressure (Bar)	Filter Disc Size
CF/2.1/208	AA214 Series	AL & PA	1/8" & 1/4"	35	25.64
CF/2.1/209	AN232 Series	AL & PA	1/4" & 1/2"	10	25.178

Aluminium Filter Housings: 1/8" to 1/2" Line Sizes

	Housing Type	Material	Port Size	Pressure (Bar)	Element Size
CF/2.1/210	AiN232 Series	AL & PA	1/8" & 1/4"	10	25.178
CF/2.1/211	AA233 Series	AL & PA	1/4" & 1/2"	17	25.178
CF/2.1/212	AiA233 Series	AL & PA	1/4" & 1/2"	17	25.178
CF/2.1/213	AA323 Series	AL	3/4" & 1"	17	38.152
CF/2.1/214	AiA323 Series	AL	3/4" & 1"	17	38.152
CF/2.1/214a	AA325 Series	AL	3/4" & 1"	100	38.152
CF/2.1/215	AA423 Series	AL	1&1/2" & 2"	17	51.476
CF/2.1/216	AiA423 Series	AL	1&1/2" & 2"	17	51.230
CF/2.1/217	AA433 Series	AL	1&1/2" & 2"	17	51.476
CF/2.1/218	AiA433 Series	AL	1&1/2" & 2"	17	51.476

Aluminium End-of-Line Filter Housings

	Housing Type	Material	Port Size	Element Size
CF/2.1/220	AE Series	AL	1/8" to 1/2"	12.32 to 25.64
CF/2.1/221	AO Series	AL	1/8" to 1/2"	12.32 to 25.178

Aluminium Filter Regulators

	Housing Type	Material	Port Size	Pressure (Bar)	Element Size
CF/2.1/225	RAN112 Series - Filter Regulator	AL & PA	1/8" to 1/4"	10	12.32
CF/2.1/226	RAA113 Series - Filter Regulator	AL	1/8" to 1/4"	17	12.32
CF/2.1/227	RAN122 Series - Filter Regulator	AL & PA	1/8" to 1/4"	10	12.57
CF/2.1/228	RAA123 Series - Filter Regulator	AL	1/8" to 1/4"	17	12.57

Brass Filter Housings

	Housing Type	Material	Port Size	Pressure (Bar)	Element Size
CF/2.1/250	BB213 Series	Brass	1/4" to 1/2"	17	25.64

PTFE Filter Housings

	Housing Type	Material	Port Size	Pressure (Bar)	Element Size
CF/2.1/300	FF111 Series	PTFE	1/8" & 1/4"	7	12.32
CF/2.1/301	FF121 Series	PTFE	1/8" & 1/4"	7	12.57
CF/2.1/302	FG121 Series	PTFE & Glass	1/8" & 1/4"	7	12.57
CF/2.1/303	FF211 Series	PTFE	1/4" & 1/2"	7	25.64
CF/2.1/304	FG211 Series	PTFE & Glass	1/4" & 1/2"	7	25.64
CF/2.1/305	FF231 Series	PTFE	1/4" & 1/2"	7	25.178
CF/2.1/306	FG231 Series	PTFE & Glass	1/4" & 1/2"	7	25.178

Polyamide (Nylon) Filter Housings

	Housing Type	Material	Port Size	Pressure (Bar)	Element Size
CF/2.1/310	NN112 Series	PA	1/8" & 1/4"	10	12.32
CF/2.1/311	NN122 Series	PA	1/8" & 1/4"	10	12.57
CF/2.1/311a	NN122.F Series	PA	1/8" & 1/4"	10	-
CF/2.1/312	NL121 Series	PA	1/8" & 1/4"	7	12.57
CF/2.1/313	NL141 Series	PA	1/8" & 1/4"	7	12.32 & 12.35
CF/2.1/314	NT Series	PA	1/8" & 1/4"	7	12.32 & 12.57
CF/2.1/315	NNS Series	PA	1/8" & 1/4"	7	25.30 & 25.35
CF/2.1/316	NN212 Series	PA	1/4" & 1/2"	10	25.64
CF/2.1/316a	NN212.F Series	PA	1/4" & 1/2"	10	-
CF/2.1/317	NN232 Series	PA	1/4" & 1/2"	10	25.178

Polypropylene Filter Housings

	Housing Type	Material	Port Size	Pressure (Bar)	Element Size
CF/2.1/320	PP111 Series	PP	1/8" & 1/4"	7	12.32
CF/2.1/321	PP121 Series	PP	1/8" & 1/4"	7	12.57
CF/2.1/322	PP211 Series	PP	1/4" & 1/2"	7	25.64
CF/2.1/323	PP231 Series	PP	1/4" & 1/2"	7	25.178

PVDF Filter Housings

	Housing Type	Material	Port Size	Pressure (Bar)	Element Size
CF/2.1/330	KK121 Series	PVDF	1/8" & 1/4"	7	12.57
CF/2.1/331	KK211 Series	PVDF	1/4" & 1/2"	7	25.64
CF/2.1/332	KK231 Series	PVDF	1/4" & 1/2"	7	25.178

Why Classic Filters?

Our high-quality filter housings and elements enable the effective and efficient removal of contaminants from both gas and liquid applications. From coalescing to particulate filtration, we ensure that, for whatever purpose our filters are used, they perform to unrivalled standards.

Filter Element Selection



A huge range of filter element types and grades give increased flexibility.

Our filter housings and elements are available in a wide variety of materials, delivering you a robust, tailor-built filtration solution to suit your particular requirements. Materials include:

- 316L Stainless Steel
- Aluminium
- PTFE
- Nylon
- Polypropylene
- PVDF
- Hastelloy
- Monel
- Titanium
- Brass
- Duplex
- Inconel

Special or Custom Products

Need an unconventional or bespoke filter element and housing?

No problem.

Our skilled designers and engineers will work alongside you to build a custom-made solution that suits your particular filtration requirements and specifications. Get in touch today for a no obligation consultation on how we can meet your needs.

Special Materials With a plethora of materials, from the most exotic metals through to standard aluminium and ordinary nylon, we can design and manufacture the most suitable filter housings and elements to suit you and your company's needs. We specialise in exotic materials such as, Hastelloy, Monel, and Titanium.

Special Ports Threaded ports and flange connections can be manufactured to specification, ensuring you receive a filter that fits seamlessly with your existing instruments and machinery.

Head to bowl seal features an o-ring in a separate groove

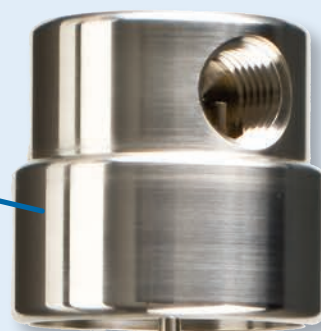

Filter housing feature a separate element retainer and tie rod that allows self-sealing filter media to be used



Filter housing available with or without a drain port. Some housings also available with a manual drain



Particulate & Coalescing Filtration

Types of Filtration

Our high-quality filter housings and elements enable the effective and efficient removal of contaminants from both gas and liquid applications. From coalescing to particulate filtration, we ensure that, for whatever purpose our filters are used, they perform to unrivalled standards.

Particulate Filtration

If particulate filtration is what you need, we offer a huge selection of robust, effective solutions to meet - and in some cases exceed - your requirements.

The service life of our high-efficiency filter elements are maximised thanks to superior design and engineering, so you can be sure of the most cost-effective, durable solution to your filtration needs.

Essentially, particulates are removed from gas and liquids using a two-port filter housing and particulate-type filter element specifically designed for this purpose.

Support cores should be used with a disposable filter element in liquid filtration applications.

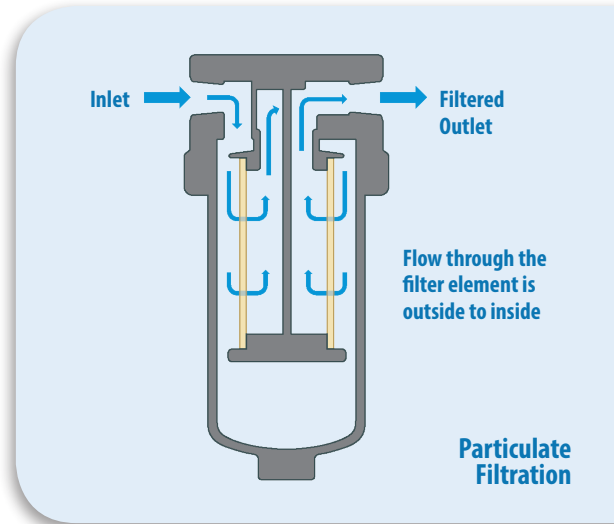

Coalescing Filtration

Processes and systems that require the separation of liquid aerosols and droplets from gas need a coalescing filter.

This type of filter element essentially comprises of two parts, an inner and an outer layer. The inner layer consists of a high-efficiency coalescing stage whilst the outer layer is a courser stage used for drainage.

Any liquid aerosols or droplets are caught within the fine fibres of the inner layer, eventually accumulating to the extent that they are forced to the outer layer of the filter element and in to the 'bowl' of the housing.

Our SV series coalescing housings offer a super-efficient filtration solution with the benefit of an inverted position of the housing ensuring easy servicing without disconnecting the drain port fittings.

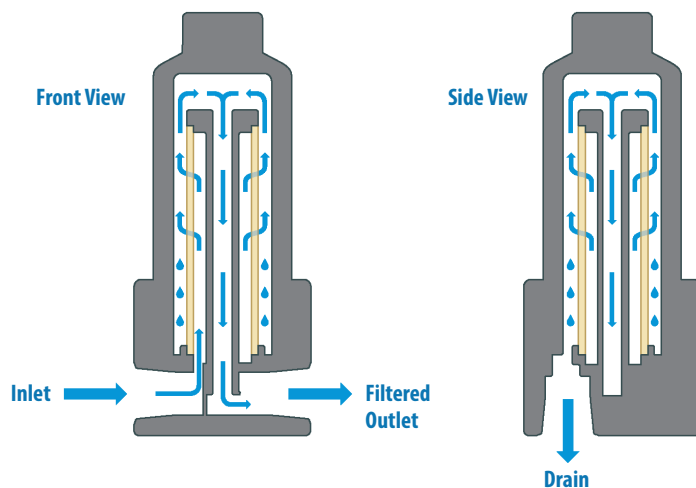
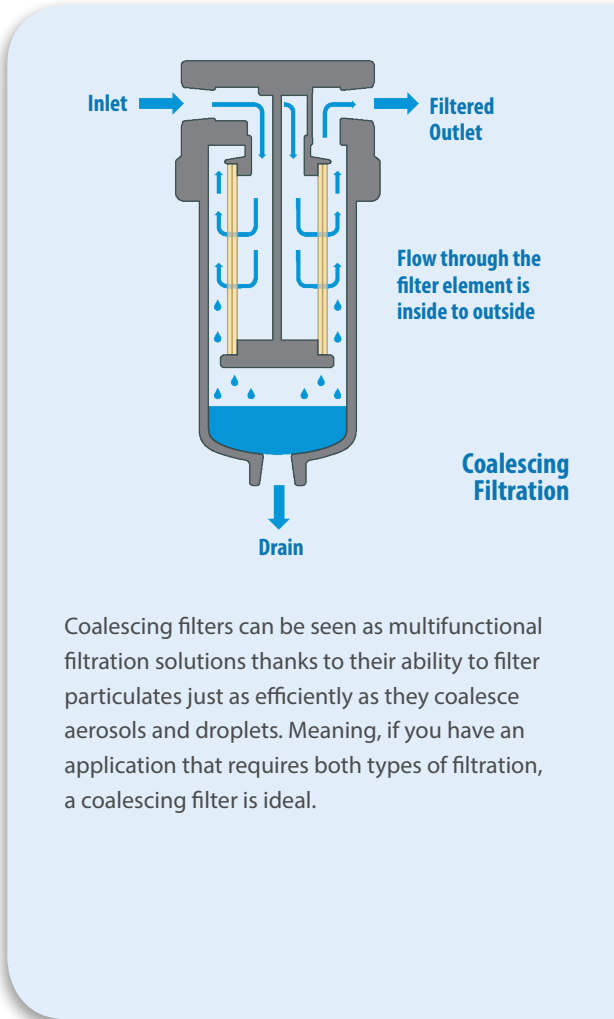

As well as our standard stocked housings, we offer a service to create custom housings to suit your application. Just let us know what you need.

Stainless Steel Filter Housings

With the widest selection of stainless steel filter housings available, Classic Filters is almost certain to have the housing that meets your particular needs. If not, we'll build you one from scratch.

As well as our standard filter housings, we also offer custom-made filter housings in plastic to suit your OEM or special application. While we traditionally supply the instrumentation and analyser sample system markets, our filters can be used in a huge range of industries and applications

Constructed entirely from 316L stainless steel, all our stock stainless steel filter housings are free of welds to comply with NACE MR-01-75. Each filter housing has a serial number to offer complete traceability of the material right back to the mill. Material certificates to EN 10204-3.1 can be supplied with the filter housing.



High Pressure to 1400 bar

With ports from 1/8" to 2" NPT and pressure ratings up to 1400 bar available from stock, our filter housings can be used in a wide range of environments and situations. Housings can also be used in vacuum applications.

CE Marks and the Pressure Equipment Directive

All our filter housings comply with the requirements of the Pressure Equipment Directive (2014/68/EU) and have CE marks if required. Non CE marked housings conform to SEP requirements. We can even produce a one-off special with CE marks.

Exotic Materials

Need something more exotic than 316L stainless steel? No matter how exotic your requirements, Classic Filters can supply materials to match. We can produce housings in a range of materials including Titanium, Hastelloy, Monel, Duplex, Super Duplex, and Inconel. Just let us know your requirements.

Filter Housing Options

A range of filter housing options can be supplied, including various seal types, as well as special port configurations, extra ports, special lengths and other design features.



Filter housings can also be supplied with Pyrex glass bowls for visual monitoring of the filter element. These are suitable for applications up to 7 bar.

Fast loop filters are ideally suited to heavily contaminated applications since the element is thoroughly and continuously flushed by the high flow-rate stream through the housing.

Again, the cost-effectiveness and service-life of your filter element are our main concern, ensuring only the low-flow stream to the analyser is being filtered.

Traditional Bypass Filtration

Our fast-loop filtration solutions go against the grain of the traditional three-port T-shape filter design, bringing with it the advantages of continued flushing on the filter element to remove heavy contaminants downstream. A reduced housing volume improves the response time.



If you still want to use the traditional style of housing in your system - no problem, our T-shaped housings can still be used.

As well as our standard stocked housings, we offer a service to create custom housings to suit your application. Just let us know what you need.

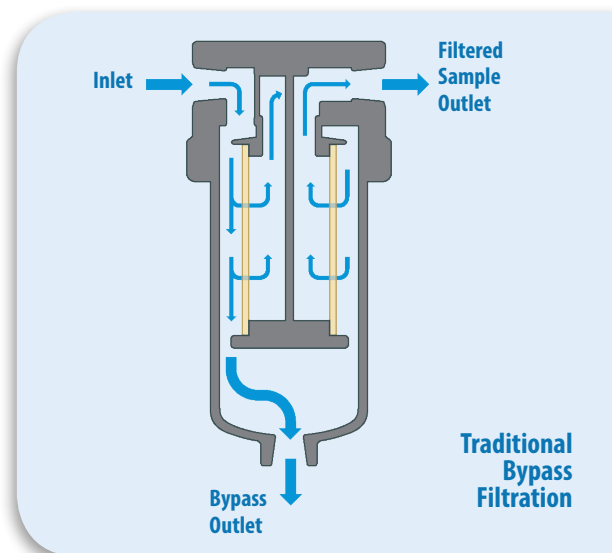
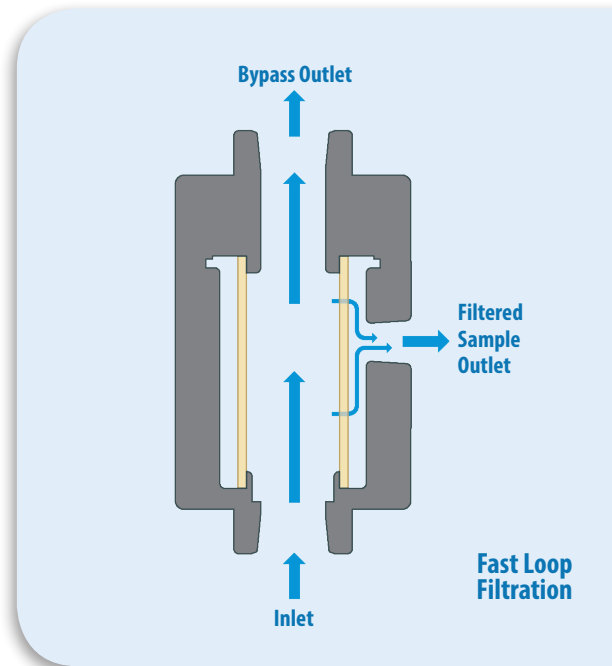

PTFE-Membrane Housings

One of our most innovative filtration solutions available, PTFE membranes are perfectly suited for separating liquid from gas molecules, allowing for a pure gas sample to be produced for the protection of analysers and other instruments. We can also separate two liquid phases if required.

A porous PTFE membrane is supported by a sintered, porous stainless steel disc on the outlet side.

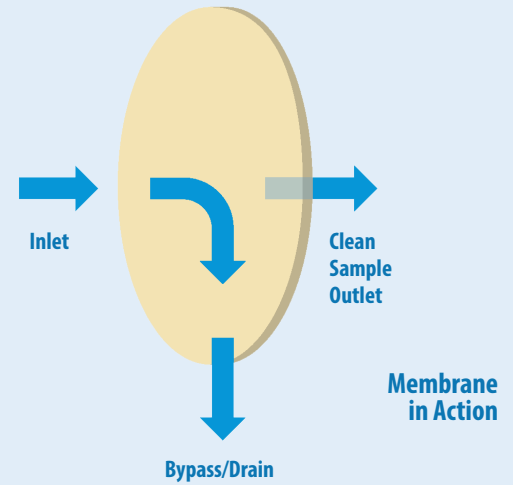

The effective combination of carefully manufactured components prevents 100% of liquid molecules from flowing through the membrane; allowing only molecules of gas to pass. Any liquid removed flows through to the drain port. This port can also be used as a bypass function for the main flow.

A range of membranes designed to separate two liquid phases are also available as well as a hydrophobic/oleophobic membrane to remove water and oils from a gas stream.

Combination Housing with Filter Element and Membrane

When used in conjunction with a filter element, the service-life of the PTFE membrane can be extended significantly, allowing the filter element to remove the bulk of the liquid before it reaches the membrane.

Just ask us about 'combination filters' when you get in touch.

As well as our standard stocked housings, we offer a service to create custom housings to suit your application. Just let us know what you need.

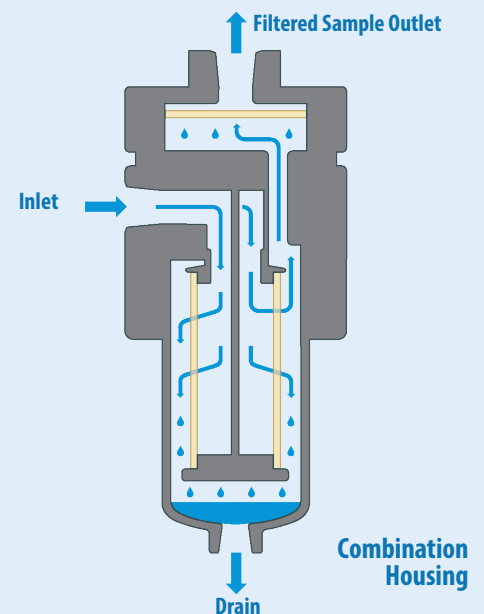

PTFE-Membrane Housing Options

Liquid Block

This option will stop the flow of the gas sample through the PTFE if the differential pressure becomes too high.

If the PTFE membrane becomes flooded, the increase in pressure drop can cause liquid to be forced through the membrane.

The valve in the housing plug will automatically close when a high differential pressure occurs and shut off the flow.



Ordering information

To order a membrane housing with this option, simply add the suffix .LB to the housing designation; so for example SM106.221.LB

Twin Support Discs

On standard membrane housings the PTFE membrane is supported by a sintered, porous stainless steel disc on the outlet side. The Twin Disc option adds another sintered support disc to the front face of the PTFE membrane.

If the flow is reversed during normal operation there is a chance that the PTFE membrane can be damaged. The second support disc on the front face of the membrane will keep it in place and prevent any damage.

Ordering information

To order a membrane housing with this option, simply add the suffix .TD to the housing designation; so for example SM106.221.TD

As well as our standard stocked housings, we offer a service to create custom housings to suit your application. Just let us know what you need.

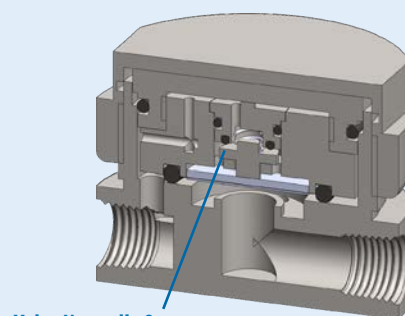

Valve Normally Open

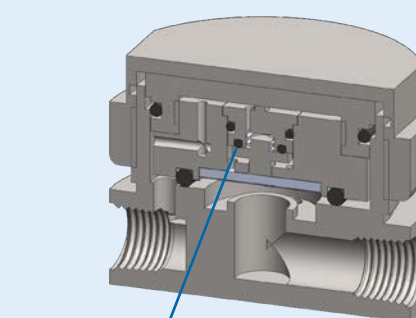

Valve closed due to excessive pressure drop across face of the PTFE membrane

Liquid Block Valve in Action

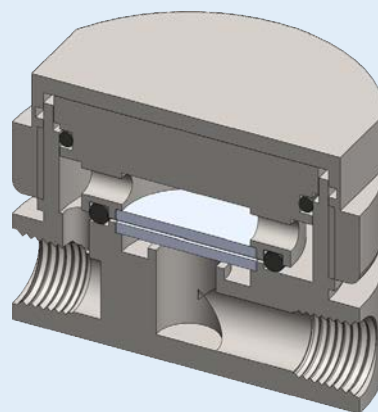

Twin Support Disc Option

Cyclone Filter Housings

Our cyclone filter housings are one of the most innovative, low-maintenance solutions for liquid bypass filtration.

The contaminated sample initially enters an angled inlet port, creating a cyclone effect in which the contaminants are filtered via a filter disc. Any particulates are blocked by the filter disc and carried to the bypass port at the bottom of the housing. The clean sample is allowed to pass through the sintered stainless steel filter disc to the sample outlet port.

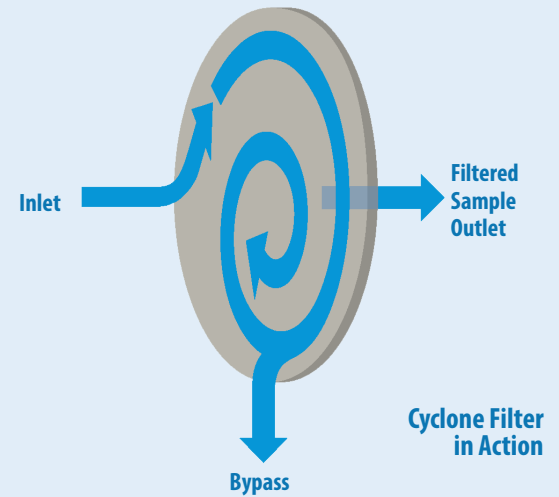

Due to this cyclone effect, the filter disc is kept clean for a long period of time, extending the period required between service intervals when compared to standard filters.

Even when a service is due, the procedure is incredibly quick thanks to the 'threaded cap' design of the housing, allowing for easy access to, and replacement of, the filter disc.

Stainless Steel Filter Discs

Our stainless steel filter discs are ultra-durable solutions to particulate filtration, especially in liquid applications. Several layers of 316 mesh are sintered together to form an integrated porous filter, with coarse mesh providing support and protection to the finer, central mesh.

Filter discs are stocked in grades, 1, 2, 5, 10, 20, 40, 100, and 200 micron.

As well as our standard stocked housings, we offer a service to create custom housings to suit your application. Just let us know what you need.



Catchpot & Bubbler Applications

Catchpots

This clever accessory is ideal for highly contaminated applications, allowing you to overcome the common problem of flooding within your coalescing filter elements if large slugs of liquid are present.

Catch pots essentially 'catch' the bulk of the liquid contaminant before it reaches the filter, hence the name 'catchpot'.

We can modify any of our existing selection of filter housing to accommodate a catchpot tube, or we can build a completely unique catchpot from scratch.

Whatever your requirements, we can deliver.

Ordering information

To order a catch pot on one of our existing housing designs, simply add the suffix .CP to the housing designation; so for example SS127.221.CP or AA213.461.CP

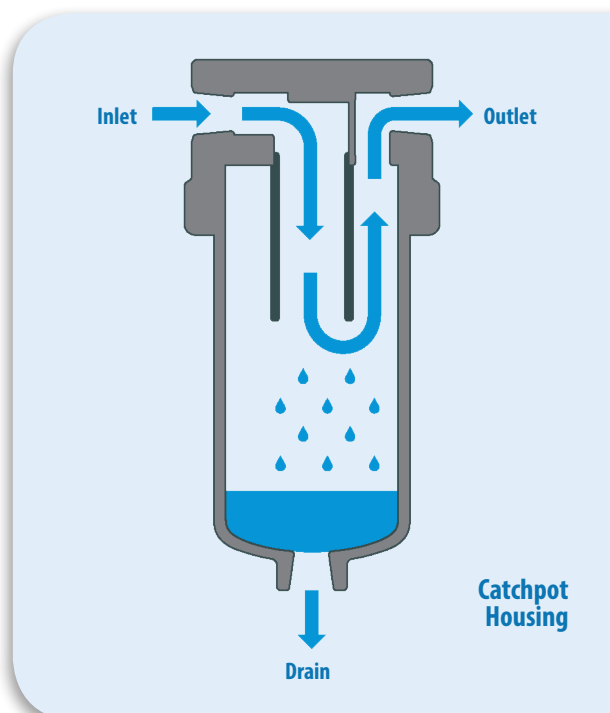

Bubblers

Bubblers are another accessory that we offer on our existing housing range and also within custom-built filtration solutions.

These appropriately named, innovative pieces of equipment allow gas to pass through liquid. A typical example would be to maintain a relative humidity in a sample through added liquid in vapour form.

Ordering information

To order a bubbler on one of our existing housing designs, simply add the suffix .BB to the housing designation; so for example SS127.201.BB or AA213.461.BB

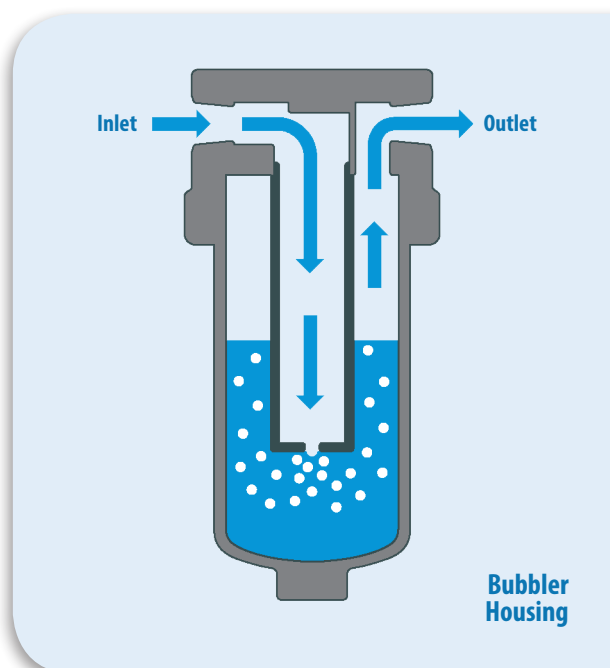

As well as our standard stocked housings, we offer a service to create custom housings to suit your application. Just let us know what you need.

Low or negative pressure gas sample systems can be problematic when it comes to removing the coalesced liquids from the 'bowl' of the housing. Dismantlement of a filter housing, in this situation, would lead to a temporary lack of pressure in the system.

That's why we offer a purpose-built drain vessel installation to suit most of our existing range of filter housings.

These carefully designed vessels allow for the isolation of liquid contaminants, whilst avoiding any negative impact on system.

Drain vessels can also be used in other applications in order to expand the volume of waste liquid that filter housings can hold, thus extending the requisite time between service intervals.



Facing the same problem with a high-pressure application?

We can manufacture drain vessels for this purpose too; get in touch for a no-obligation chat.

As well as our standard stocked housings, we offer a service to create custom housings to suit your application. Just let us know what you need.

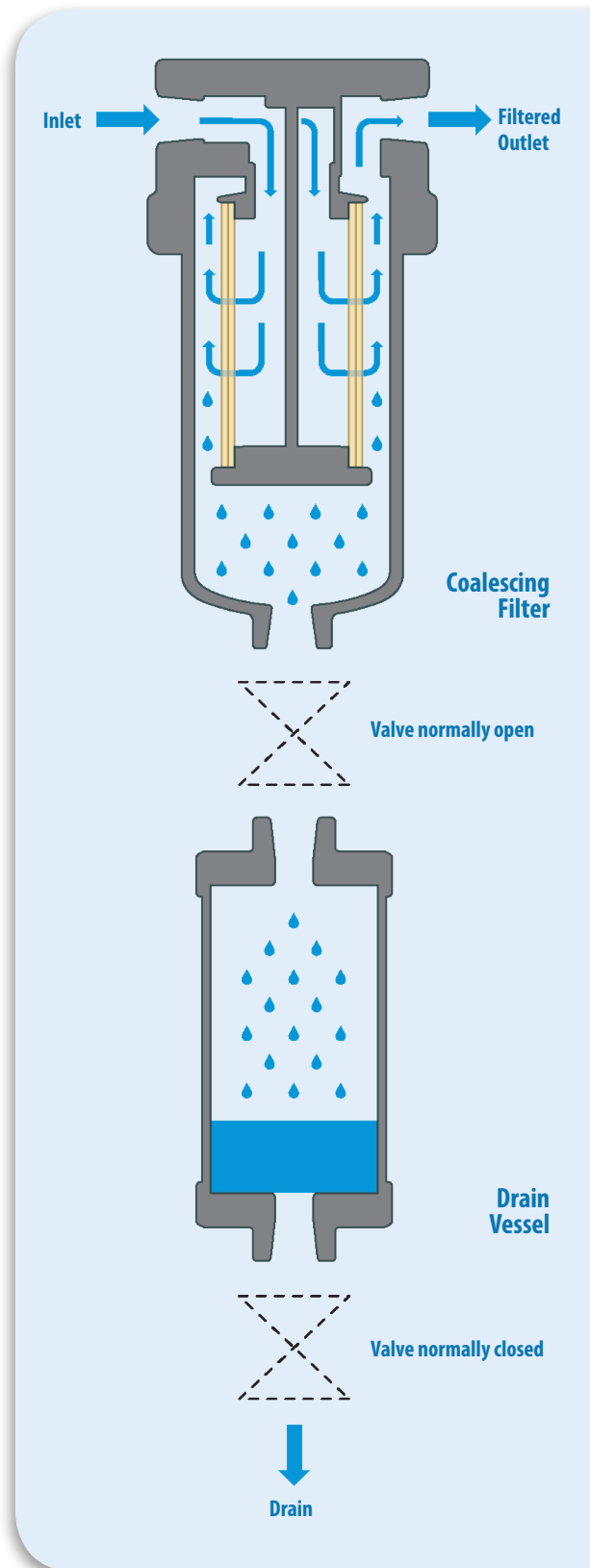

Automatic Float Drains

To remove liquids automatically, from a system with a positive pressure, we have two solutions -

The DF105 series automatic float drain uses a unique diaphragm operated valve and is constructed entirely from 316L stainless steel for use in corrosive applications.

Water drains from the coalescing housing into the drain body and as the water level increases a float controls the diaphragm operation of the valve. Once the water is drained, the float returns to the rest position and the valve closes.



DN103 and DF105 Automatic Float Drains



For lower pressure non-corrosive applications, the DN103 series automatic float drain uses a self-contained plastic float mechanism to remove water in a similar way to the DF105 series.

As well as our standard stocked housings, we offer a service to create custom housings to suit your application. Just let us know what you need.

SBF Flanged Housings

The SBF flanged housings are designed to be weld-free. The heads are machined from solid stainless steel bar.

By removing the welding process, the costly additional documentation, approvals and testing for CE marking are eliminated.

Various flange types and pressure rating are offered as standard. Sizes from 1/2" up to 2" can be produced.



SBF Series Housing



Several flange types and sizes are available as standard designs and are based on our SS series housings

Special Designs

Need an unconventional or bespoke housing?

No problem.

Our skilled designers and engineers will work alongside you to build a custom-made solution that suits your needs.

Just let us know what you need.

Flange Types Available Include -

- ASME/ANSI B16.5 - 1996 - Pipe Flanges and Flanged Fittings
- British Standard BS 4504 - Section 3.1:1989 - Circular Flanges for Pipes, Valves and Fittings
- SAE J 518 C - SAE Flanges Standard

Heatable Housings

These housings are specifically engineered for hot gas analysis, in particular, diesel exhaust – this gas has an especially high dew-point, so to prevent condensation during analysis, the sample must be heated.

In essence then, these housings offer the same level of quality as all our stainless steel housings, but with the added benefits of a housing designed for a specific application.

Filter elements used in heatable housings can be replaced quickly and easily (even at operating temperatures) thanks to a quick-release bayonet connection, thus minimising disruption to your analysis and operations.

Optional configurations of the ports and internals include a support core or a tie rod and element retainer.

Disposable, S-type filter elements are perfect for heated applications when used in tandem with Heatable Housings

As well as our standard stocked housings, we offer a service to create custom housings to suit your application. Just let us know what you need.

Heatable housings available
in a wide range of sizes

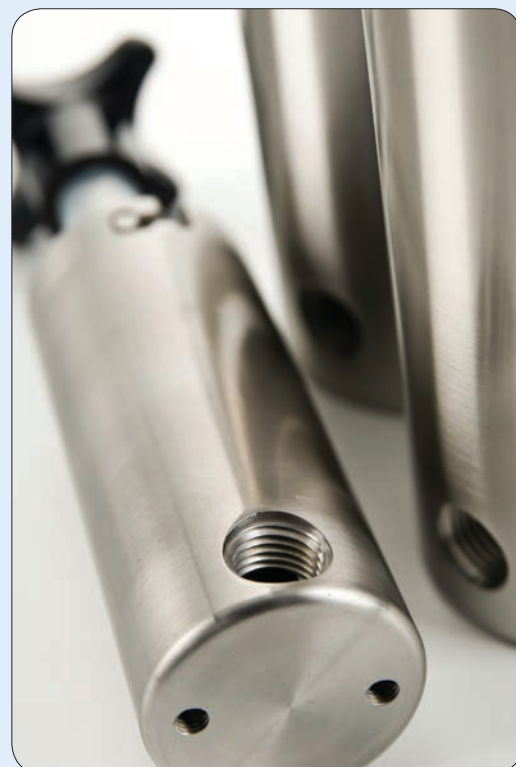

Several port and internal options are available and housings have threaded mounting bracket holes as standard



Quick-release bayonet connection for the head to bowl

Aluminium Filter Housings

If you use compressed air for instrument or industrial applications, efficiency and flow-rate are of paramount importance. Aluminium filter housings for particulate and coalescing filter applications

Classic Filters' high-efficiency aluminium filter housings are purpose built for compressed air applications in mind. With a wide selection of port sizes and pressure ratings available, we will provide a high efficiency filtration solution to suit your application requirements.

Special Filter Housings and OEM Applications

Does your application have special filter requirements? As well as our standard housings we also offer bespoke filter housings manufactured in aluminium and plastics to suit your OEM product or special application. Contact our team with your requirements today.

High Pressure to 250 bar

With ports ranging from 1/8" to 2" NPT and pressure ratings from 7 to 35 bar available from stock, our filter housings can be used in a wide range of environments and situations. Of course, if you need very high pressures, we have produced aluminium filter housings up to 250 bar and our stainless steel filter housings for higher pressures are also available.



Catchpot Housings

If there is a high chance of bulk liquid flowing through the line with the compressed air to the coalescing filter, it is good practice to use a catchpot before the coalescing filter to increase the performance and prevent the filter element from flooding.

Filter Housing Options

A range of filter housing options can be supplied with a variety of seal types and other options to suit your needs.



Aluminium housings available in a wide range of sizes

Special Designs?

Need an unconventional or bespoke housing?

No problem.

Let our skilled designers & engineers take care of every aspect including:

- Port Sizes
- OEM Labeling
- Differential Pressure Indicators
- Automatic/Manual Drains
- Sealing Types

Available in Nylon, Polypropylene, PTFE or PVDF, Classic Filters offer a range of low-cost plastic filter housing solutions that deliver high-performance corrosion resistance.

Materials: PA, PP, PTFE and PVDF

PTFE filter housings are machined from solid PTFE bar and have a 316L stainless steel collar on the outside of the head to increase the strength of the head to bowl connection. When the PTFE filter housings are used with our PTFE filter elements, a 100% PTFE filter solution is available. Other plastic filter housings are moulded in quality, high-performance materials

Our plastic filter housings are ideal for emissions and environmental filter applications as well as other OEM filter applications requiring a low-cost solution. They can be used for both particulate and coalescing applications. They can be supplied as catchpots and bubbler housings. They can also be fitted with adsorber cartridges.

Port sizes from 1/8" up to 1/2" help to offer great flexibility from this range of products and the can be supplied with or without drain ports.



Special Filter Housings and OEM Applications

Does your application have special filter requirements? In addition to standard filter housings, Classic Filters offers custom-made filter housings based on our proven NL, NT and NNS housings that are ideal for OEM or special applications.

Let us know what you need.



Float Valve Housing

Float valve housings are an essential filtration tool when gas is being drawn to an analyser or other instrument, preventing the carry-over of bulk liquids. Normally these are used after coalescing filter housing as a safety device.



Ordering information

Two sizes of plastic housing can be supplied: The small NN122 or the larger capacity NN212.

To order this type of housing, simply add the suffix .F to the housing part number; so for example NN122.161.F or NN212.261.F

A small 316L stainless steel housing using a PVDF float is also available, the SS125.F series, and as well as our standard stocked housings we offer a service to create custom housings to suit your application. Just let us know what you need.

How they work:

As liquid is collected in the bowl, the level starts to rise, gas becomes trapped in the open-end of the float and it too starts to rise.

The entire float assembly then begins to move upwards and eventually closes the valve and shuts off the flow to the analyser. This loss of flow is then detected and an alarm is sounded.

Without the float valve, the flow remains open to the analyser, substantial damage could be caused through the transmission of liquid into the analyser. Float valve housings can therefore protect you from costly repairs.

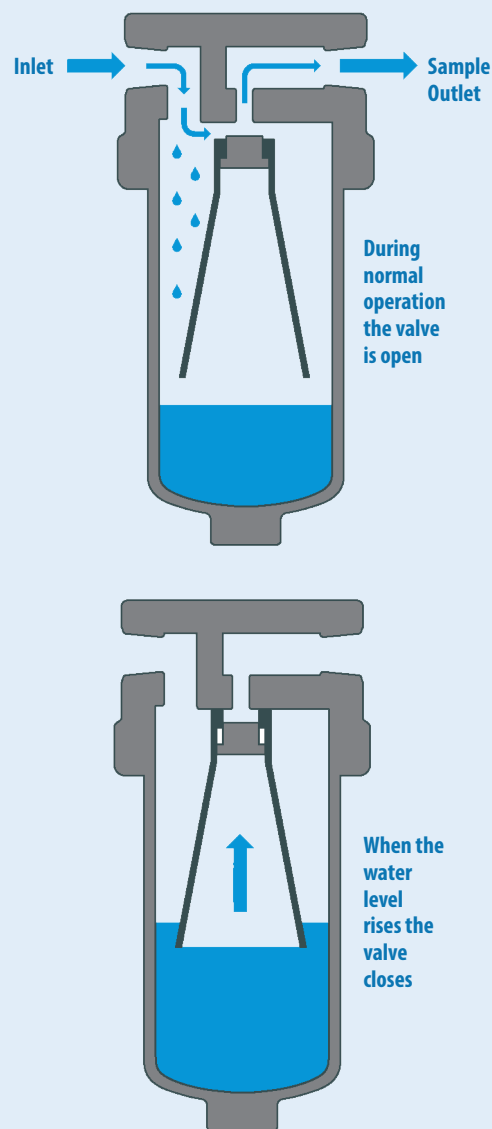

Differential Pressure Indicators

These housings are specifically engineered to offer an indication of the differential pressure across the filter element. They offer a cost effective method of monitoring the service life and prevent costly failures due to lack of maintenance.

The SiS series housings feature a visual indication. A plunger sealed by an o-ring separates an area of the head into two chambers. A spring causes the plunger to take up its home position when the pressure difference is zero.

As the pressure difference increases, the plunger is forced to move against the spring. At the same time, an indicator disc is moved magnetically. The indicator will show yellow when the differential pressure is 0.25 bar and red when it reaches 0.5 bar.

The SeS series housings use the same mechanical system as the SiS, except the two reed contact switches are actuated.

As well as our standard housings, we offer a service to create custom housings to suit your application.

Just let us know what you need.

Most stainless steel housings can be supplied with a differential pressure Indicator

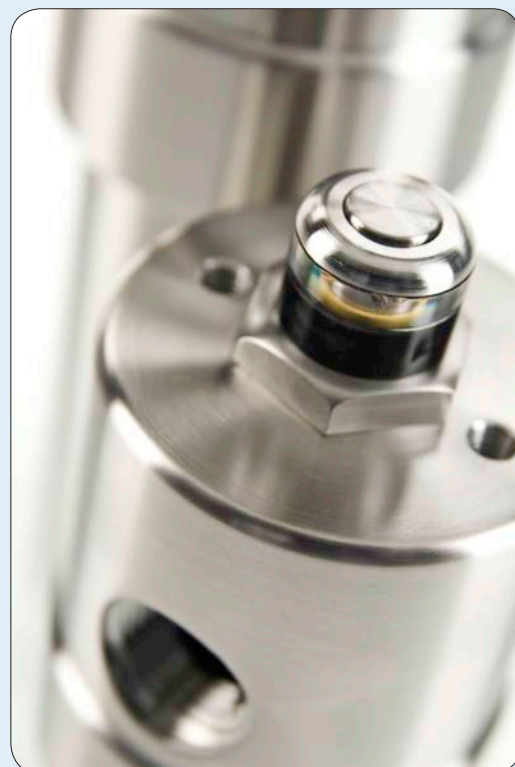

The SiS series housings feature a visual indicator

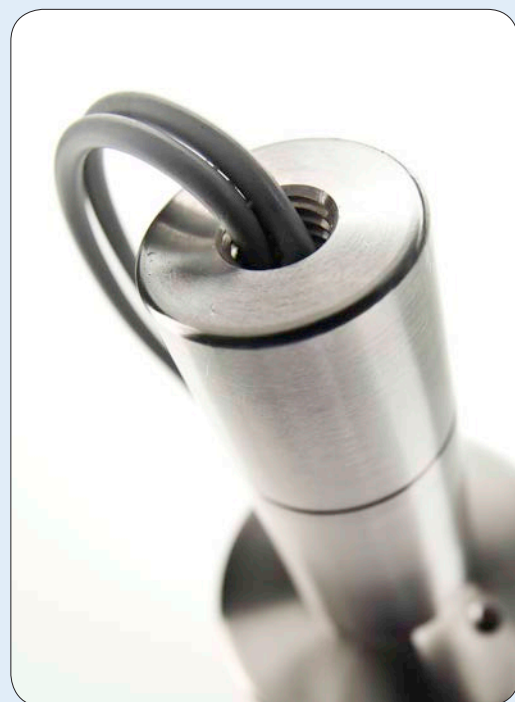

The SeS series housings offer electrical control

Sealing Options

Filter housings are mostly fitted with Viton o-ring style seals as standard. We have a number of sealing options that can be specified and the housings delivered with the seals installed.

For alternative seals, a suffix is added to the filter housing part number, for example if you require a SS127.221 filter housing with an EPDM seal add .E to give SS127.221.E - if a standard seal is required do not add the suffix

Refer to the filter housing data sheets for information about the seals types available for each housing.

Please consult us for any special requirements.



Types of Seals

Suffix	Name	Type	Temp. Range
.V	Viton	Fluorocarbon	- 30°C to +200 °C
.C	Chemraz	Perfluorelastomer	- 18°C to +324°C
.T	PTFE	FEP Encapsulated ⁽¹⁾	- 60°C to +200 °C
.T	PTFE	Solid PTFE ⁽¹⁾	- 260°C to +200 °C
.K	Kalrez	Perfluorelastomer	- 50°C to +316°C
.S	Silicone	Silicone	- 60°C to +230°C
.R	Neoprene	Chloroprene-Neoprene	- 45°C to +100°C
.E	EPDM	Ethylene-propylene	- 55°C to +150°C
.N	Nitrile	Buna N-Nitrile	- 35°C to +110°C

(1) Please note that some housing designs can only use the FEP encapsulated seals

Mounting Brackets

Mounting brackets can be supplied for all filter housings making the installation process quicker and easier. All our mounting brackets are supplied with screws and washers to join them to the housing so only fixings for the panel or wall are required.

Use of a mounting bracket will avoid excessive loads on the fittings and piping.

All mounting brackets are constructed in stainless steel giving superior corrosion resistance in wet areas.

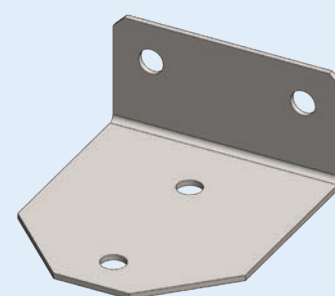

Support Cores

When using disposable filter elements in a liquid application, a support core should be used to increase the strength of the filter elements.

Plastic and aluminium housings have a built in support, but stainless steel housings will need to use the optional extra support.

The SC series support cores are constructed from 316L stainless steel.



Selecting the Correct Filter Housing

How to select the Correct Filter Housing -

The wide range of filter housing and element combinations enable us to supply the most suitable equipment for your application and specifications.

To select the correct filter housing and element, the following information about the application is required -

1	Maximum pressure
2	Maximum temperature
3	Chemical & physical composition of the sample
4	Type of duty: inlet, particulate, coalescing, bypass, membrane
5	Contaminants to be removed
6	Maximum flow rate
7	Line size and port type
8	Level of filtration required
9	Relative importance of cost, response time, service life and interval

Items 1, 2 and 3 will determine the materials of construction of the filter housing, including the element and seals. Filter housings are available in a wide variety of materials to ensure there is a product for even the most specialised applications. As well as our range of standard materials a wide range of exotic materials are also available.

Item 4 will determine the configuration of the housing, one port for inlet filters, two ports for in-line housings and three ports for coalescing, bypass or fast loop housings.

Items 5, 6, 7, 8 and 9 will establish the most appropriate size of filter. This is generally a compromise between those factors favouring a small filter (fast response time, smallest space requirement, lowest cost, minimised adsorption losses) and those factors favouring a large filter (long service intervals, low pressure drop). The exact choice will therefore depend on the relative importance of these factors in each particular application.



Additional Assistance

Our representatives have a vast experience of specifying successful installations and we will be pleased to help you select the best solution for your filtration problem.

We also have an Applications Form available for you to complete and return and this will ensure we have all the information required to make a selection for your individual application.

Service Intervals

A disposable microfibre filter element continues to filter at its original efficiency as long as it is kept in service. The life of the element is determined by the increase in flow resistance caused by trapped solids. The element should be changed when the flow falls below an acceptable level, or the pressure drop becomes too high. In any case the element should be replaced before the pressure drop across it reaches 0.7 Bar. The disposable microfibre filter elements cannot be cleaned as the solids are trapped within the depth of the element not on the surface.

Installing the Filter Housing

Given that filter housing is a pressure vessel, any connections and accessory outlets must be leak-tight.

Therefore, a good pipe sealant (PTFE tape, paste etc.) should be used on all fittings prior to connecting the filter housing ports. This will also allow for disassembly at a later time, if required.

Wherever possible, installation of filter housings should be made using an appropriate mounting bracket to avoid excessive loads on the piping.

Full installation instructions are included with each filter housing.

Materials **316L SS & Polyamide**
Pressure **17 Bar**
Ports **1/8" or 1/4"**

The DN103 automatic drains are used to remove liquids from a coalescing filter housing under positive pressure. The body is constructed from 316L stainless steel and the internals are a proprietary float drain assembly.

This housing should only be used in non-corrosive applications as the internals use polyamide componets. See the DF105 series for housings that have internals constructed entirely from stainless steel.

The housing has a male inlet port and this is connected directly to the drain port of the coalescing filter housing. Standard housings have NPT ports and Viton seals.

The housings are free from welds and comply with NACE MR-01-75 and conform to SEP of PED 2014/68/EU.



Technical Specifications

Housing Model	DN103.111	DN103.221
Port Size	1/8" NPT	1/4" NPT
Drain	1/8" NPT	1/4" NPT
Maximum Pressure, Bar	17	17
Minimum Pressure, Bar	1	1
Maximum Temperature, °C	80	80
Materials of Construction (1)		
Head & Bowl	316L SS	316L SS
Internals	PA	PA
Seal (2)	Viton	Viton
Principal Dimensions in mm		
Diameter	48	48
Height	95	95
Volume, cc	40	40
Weight, kg	0.65	0.65

Notes

(1) Material abbreviations, 316L SS = 316L Stainless Steel, PA = Polyamide

(2) Add suffix for other seal types, Nitrile = N, EPDM = .E, Silicone = .S, (e.g. DN103.221.E)