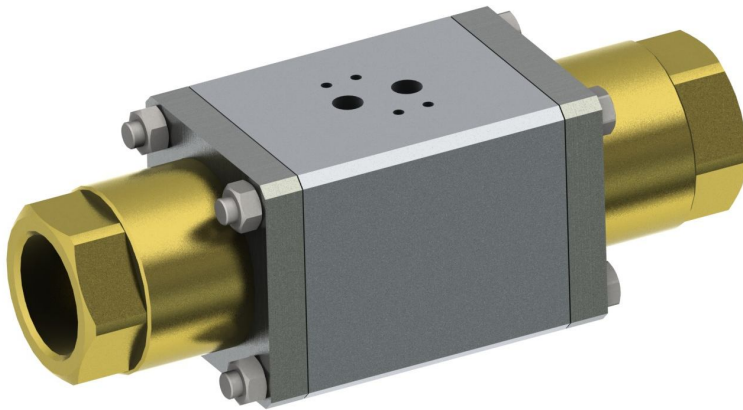
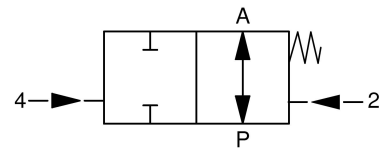
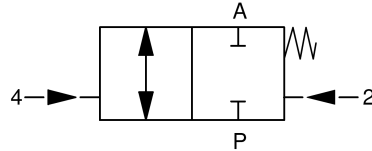

**2/2-Wege Coaxialventil**  
*2/2-way coaxial valve*
**Baureihe 280 / 281 / 282**  
**Type 280 / 281 / 282**
**fremdgesteuert**  
*externally controlled*

 Schaltfunktion A: NC (stromlos geschlossen)  
*function A: NC (normally closed)*

 Schaltfunktion B: NO (stromlos offen)  
*function B: NO (normally open)*

<b>Nennweite</b>	DN 10 – 50	<b>diameter</b>	DN 10 – 50
<b>Druckbereich</b>	0 – max. 160bar gedrückt bis max. 16bar	<b>pressure range</b>	0 – max. 160bar backpressure leakproof up to max. 16bar
<b>Gehäusewerkstoff</b>	Muffenausführung: Messing, 1.4305, 1.4571 Flanschausführung: Stahl verzinkt, Stahl vernickelt, 1.4571	<b>body material</b>	threaded version: brass, AISI 303, AISI 316 flange version: steel galvanized steel nickel-plated, AISI 316
<b>Dichtwerkstoff</b>	statisch: FKM dynamisch: FKM, PTFE Sitzdichtung: PTFE	<b>seal material</b>	static: FKM dynamic: FKM, PTFE seat seal: PTFE
<b>Temperatur</b>	Medium: -10 bis +100°C Umgebung: -10 bis +50°C	<b>temperature</b>	media: -10 up to +100°C ambient: -10 up to +50°C
<b>Anschluss</b>	G1/4 – G2 Flansch siehe Tabelle Seite 4	<b>connection</b>	G1/4 – G2 flange see table page 4
<b>Durchflussrichtung</b>	P → A max. 160bar A → P max. 16bar	<b>flow direction</b>	P → A max. 160bar A → P max. 16bar
<b>Antriebsteil</b>	doppelt wirkender Kolben mit Rückstellfeder	<b>actuating part</b>	double acting piston with return spring
<b>Steuerdruck</b>	3 – 8bar Anschlüsse 2+4 (G1/4) Schnittstelle nach NAMUR  eine vorgeschaltete Wartungseinheit verlängert die Lebensdauer der Ventile	<b>control pressure</b>	3 – 8bar connections 2+4 (G1/4) port according to NAMUR  an upstreamed service unit extends the lifetime of the valves
<b>Schaltzeiten</b>	Öffnen / Schließen 50 – 1000ms abhängig von Steuerdruck, Pilotventil (Option) und Abluftdrosseln (Option)	<b>switching time</b>	opening / closing 50 – 1000ms depending on operating pressure, pilot valve (option) and exhaust air throttle (option)
<b>Einbaulage</b>	beliebig	<b>mounting</b>	in any position

**2/2-Wege Coaxialventil**  
*2/2-way coaxial valve*
**Baureihe 280 / 281 / 282**  
**Type 280 / 281 / 282**

Baureihe type	DN [mm]	Druck pressure range [bar]	Anschluss connection	K <sub>v</sub> -Wert flow rate [m <sup>3</sup> /h]	Gewicht - Messing weight - brass [kg]
280	10	0 - 64	G1/4, G3/8, G1/2	2,7	1,6
280	15	0 - 64	G3/8, G1/2, G3/4	7,2	2,8
280	20	0 - 64	G1/2, G3/4, G1	9,4	4,0
280	25	0 - 64	G3/4, G1, G1 1/4	14,5	5,3
280	32	0 - 64	G1, G1 1/4, G1 1/2	20,0	6,9
280	40	0 - 64	G1 1/2	45,7	11,7
280	50	0 - 64	G2	47,2	11,7
281	10	0 - 120	G1/4, G3/8, G1/2	2,7	1,6
281	15	0 - 120	G3/8, G1/2, G3/4	7,2	2,8
281	20	0 - 120	G1/2, G3/4, G1	9,4	4,0
281	25	0 - 120	G3/4, G1, G1 1/4	14,5	5,3
281	32	0 - 100	G1, G1 1/4, G1 1/2	20,0	6,9
281*	40	0 - 100	G1 1/2	45,7	11,7
281*	50	0 - 100	G2	47,2	11,7
282	10	0 - 160	G1/4, G3/8, G1/2	2,7	1,6
282	15	0 - 160	G3/8, G1/2, G3/4	7,2	2,8
282	20	0 - 160	G1/2, G3/4, G1	9,4	4,0
282	25	0 - 160	G3/4, G1, G1 1/4	14,5	5,3

\*Auf Anfrage

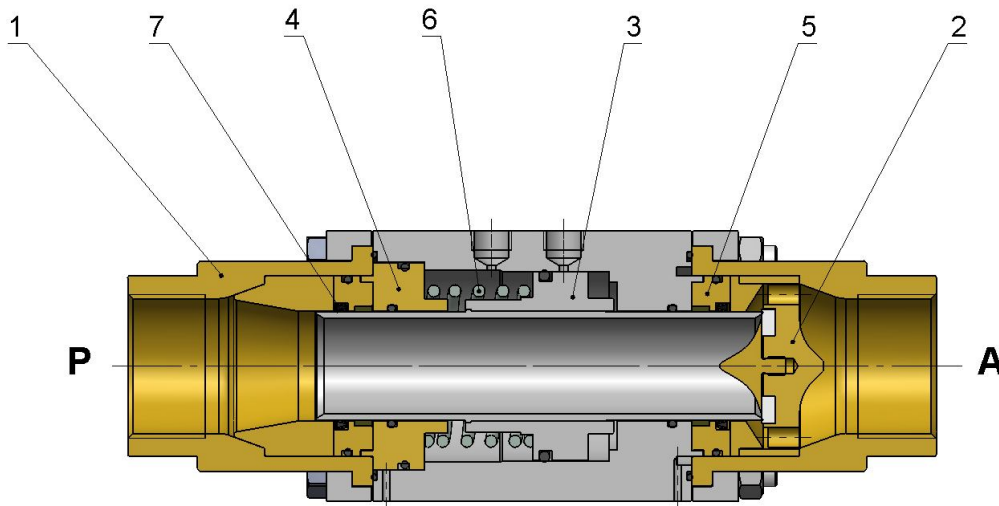
**Schnittzeichnung**  
*sectional drawing*

Pos. pos.	Menge quantity	Benennung	description
1	2	Anschlussstück	adapter fitting
2	1	Ventilsitz	valve seat
3	1	Kolben / Steuerrohr	piston / control tube
4	1	Betätigungsscheibe	actuating plate
5	2	Führungsscheibe	guiding disk
6	1	Feder	spring
7	2	PTFE-Stangendichtung	PTFE-rod seal

Technische Änderungen vorbehalten / modifications reserved · Stand / stand: 07/2014

**RSG Regel- und Steuergeräte GmbH**

Klingenweg 1 · D-74653 Ingelfingen · ☎ +49 (0) 7940/9310-0 · 📠 +49 (0) 7940/9310-60 · www.rsg-top.de · info@rsg-top.de

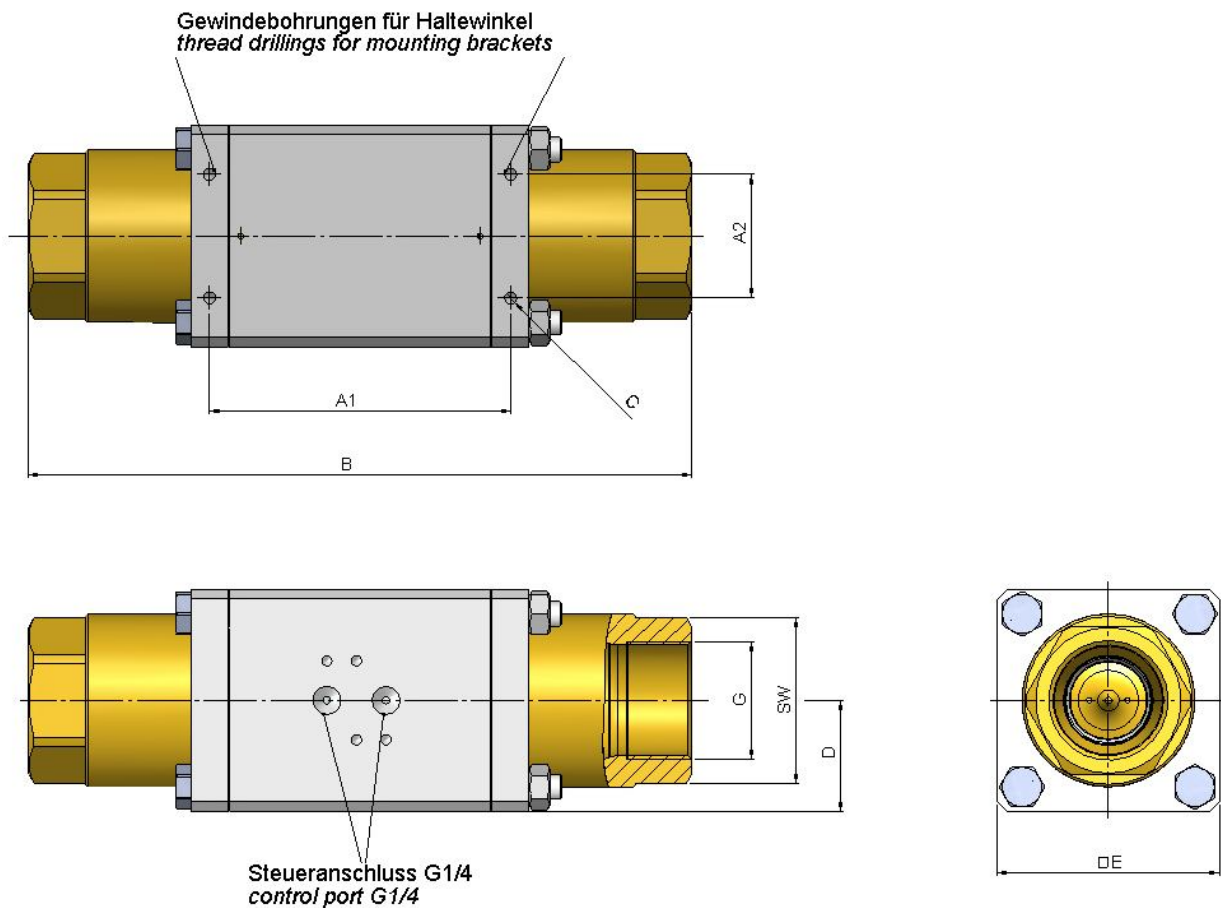
**2/2-Wege Coaxialventil**  
*2/2-way coaxial valve*
**Baureihe 280 / 281 / 282**  
**Type 280 / 281 / 282**
**Maßzeichnung**  
*dimension drawing*

**Anschlussbild nach Namur**  
*mounting face according to Namur*

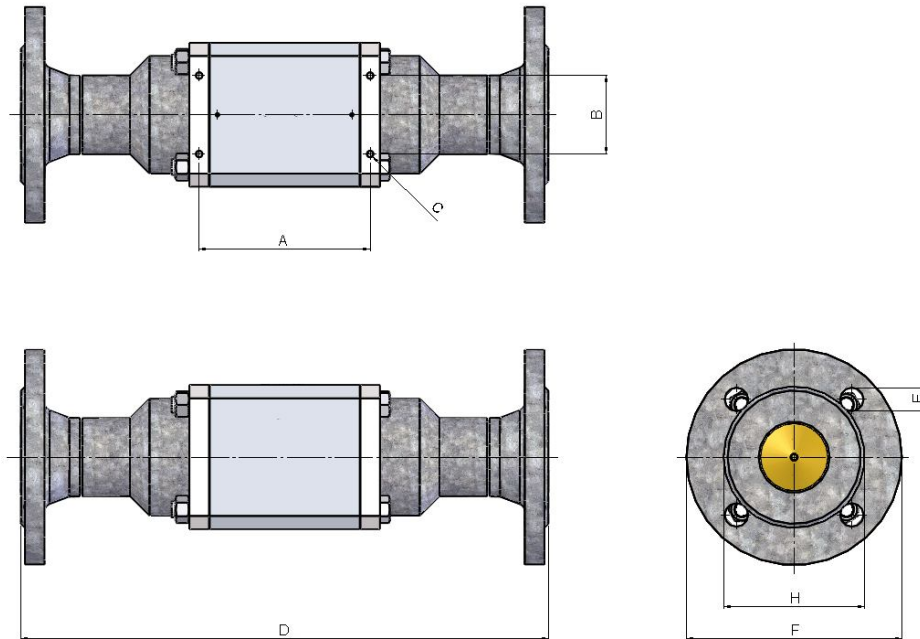
DN [mm]	G	SW	A1 [mm]	A2 [mm]	B [mm]	C	D [mm]	E [mm]
10	1/4, 3/8, 1/2	32	84	-	159,5	M4	25	50
15	3/8, 1/2, 3/4	41	100	-	184	M5	35	70
20	1/2, 3/4, 1	46	108	-	215	M5	40	80
25	3/4, 1, 1 1/4	55	121	-	246	M5	45	90
32	1, 1 1/4, 1 1/2	60	122	50	269	M6	45	90
40	1 1/2	75	131	60	304	M6	55	110
50	2	75	131	60	304	M6	55	110

**2/2-Wege Coaxialventil**  
*2/2-way coaxial valve*
**Baureihe 280 / 281 / 282**  
**Type 280 / 281 / 282**
**Maßzeichnung Flanschventile**  
*dimension drawing flange valves*

Flansch - Norm flange - standard		Druckstufe PN pressure rating	DN Flansch DN flange	DN Ventil DN valve	K <sub>v</sub> -Wert flow rate	A	B	C	D	E	F	H
DIN	EN	[bar]			[m <sup>3</sup> /h]	[mm]	[mm]	[mm]	[mm]	[mm]	[mm]	[mm]
2633	-	16	15	15	6,6	100	-	M5	242	14	95	65
2633	-	16	20	20	9,4	108	-	M5	269	14	105	75
2633	-	16	25	25	14,5	121	-	M5	302	14	115	85
2633	-	16	32	32	20,0	122	50	M6	324	18	140	100
2633	-	16	40	40	38,2	131	60	M6	385	18	150	110
2633	1092-1 Typ 11	16	50	50	47,2	131	60	M6	385	18	165	125
2635	1092-1 Typ 11	40	15	15	6,6	100	-	M5	242	14	95	65
2635	1092-1 Typ 11	40	20	20	9,4	108	-	M5	269	14	105	75
2635	1092-1 Typ 11	40	25	25	14,5	121	-	M5	302	14	115	85
2635	1092-1 Typ 11	40	32	32	20,0	122	50	M6	324	18	140	100
2635	1092-1 Typ 11	40	40	40	38,2	131	60	M6	385	18	150	110
2635	1092-1 Typ 11	40	50	50	47,2	131	60	M6	385	18	165	125
-	1092-1 Typ 11	63	50	50	47,2	131	60	M6	385	22	180	135
2636	-	64	50	50	47,2	131	60	M6	385	22	180	135
2637	1092-1 Typ 11	100	15	15	6,6	100	-	M5	242	14	105	75
-	1092-1 Typ 11	100	20	20	9,4	108	-	M5	269	18	130	90
2637	1092-1 Typ 11	100	25	25	14,5	121	-	M5	302	18	140	100
-	1092-1 Typ 11	100	32	32	20,0	122	50	M6	324	22	155	110
2637	1092-1 Typ 11	100	40	40	38,2	131	60	M6	385	22	170	125
2637	1092-1 Typ 11	100	50	50	47,2	131	60	M6	385	26	195	145
2638	1092-1 Typ 11	160	15	15	6,6	100	-	M5	242	14	105	75
2638	1092-1 Typ 11	160	25	25	14,5	121	-	M5	302	18	140	100

## 2/2-Wege Coaxialventil 2/2-way coaxial valve



## Baureihe 280 / 281 / 282 Type 280 / 281 / 282

### Typenschlüssel type code

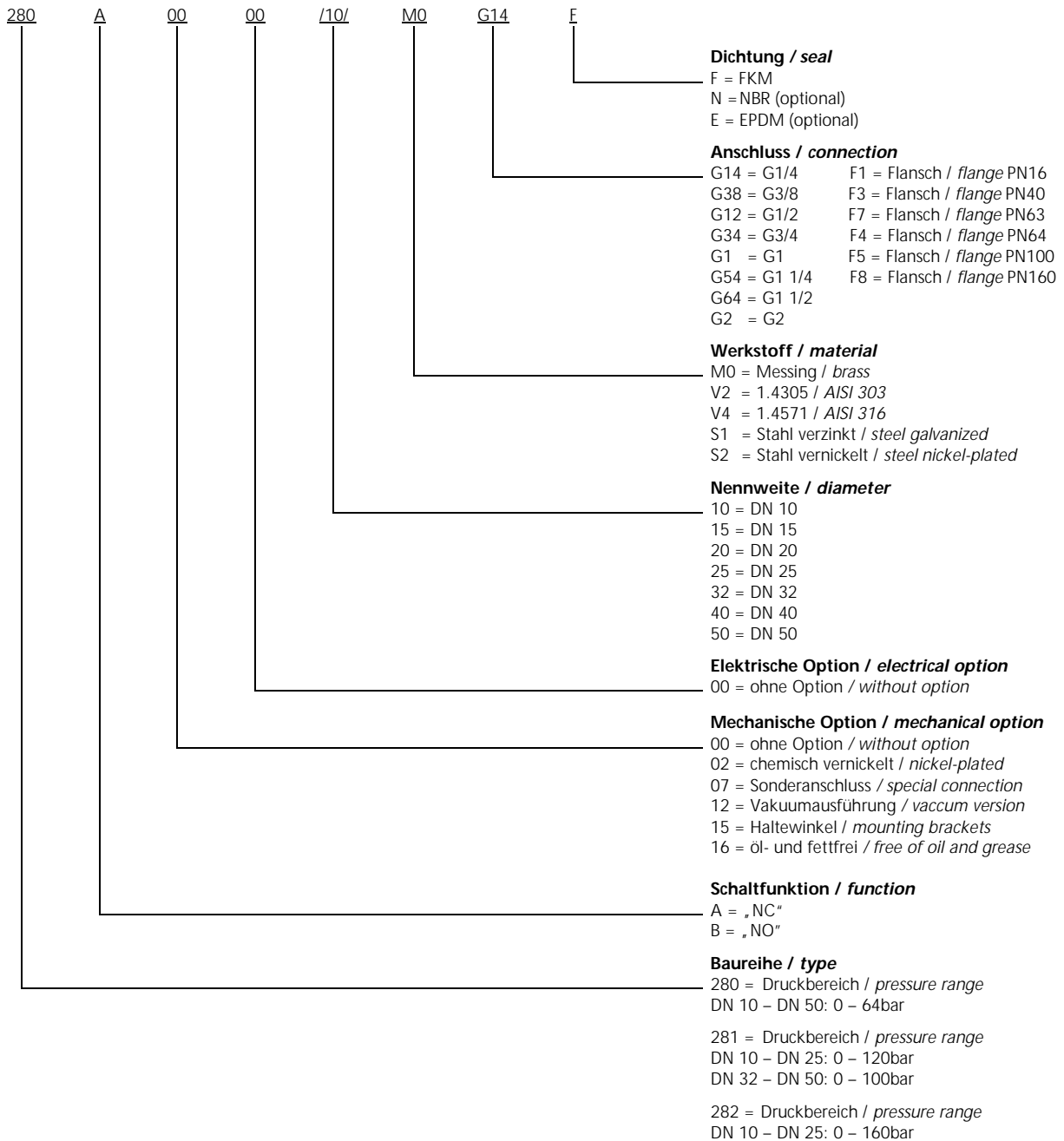

Die Typenbezeichnung setzt sich zusammen aus:  
structure of the order specification:

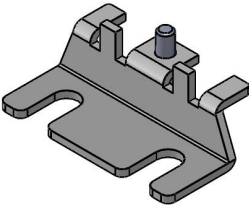
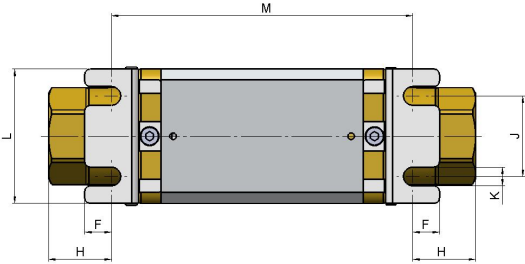

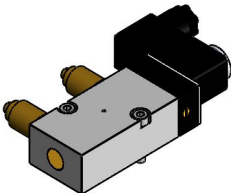
**2/2-Wege Coaxialventil**  
*2/2-way coaxial valve*
**Baureihe 280 / 281 / 282**  
**Type 280 / 281 / 282**
**Zubehör**  
*accessories*

	<p><b>Haltewinkel</b> <i>mounting brackets</i></p> <p><b>mechanische Option = 15</b> <i>mechanical option = 15</i></p>	 <table border="1" data-bbox="826 779 1433 1077"> <thead> <tr> <th>DN</th> <th>F</th> <th>H</th> <th>J</th> <th>K</th> <th>L</th> <th>M</th> </tr> <tr> <th>[mm]</th> <th>[mm]</th> <th>[mm]</th> <th>[mm]</th> <th>[mm]</th> <th>[mm]</th> <th>[mm]</th> </tr> </thead> <tbody> <tr> <td>10</td> <td>10</td> <td>23,5</td> <td>30</td> <td>7</td> <td>50</td> <td>113</td> </tr> <tr> <td>15</td> <td>10,5</td> <td>22,5</td> <td>45</td> <td>7</td> <td>70</td> <td>139</td> </tr> <tr> <td>20</td> <td>15,3</td> <td>33,5</td> <td>50</td> <td>7</td> <td>80</td> <td>149</td> </tr> <tr> <td>25</td> <td>16</td> <td>34</td> <td>60</td> <td>8,5</td> <td>90</td> <td>178</td> </tr> <tr> <td>32</td> <td>6</td> <td>37</td> <td>78</td> <td>6,5</td> <td>90</td> <td>195</td> </tr> <tr> <td>40</td> <td>6</td> <td>40</td> <td>98</td> <td>6,5</td> <td>110</td> <td>224</td> </tr> <tr> <td>50</td> <td>6</td> <td>40</td> <td>98</td> <td>6,5</td> <td>110</td> <td>224</td> </tr> </tbody> </table>	DN	F	H	J	K	L	M	[mm]	[mm]	[mm]	[mm]	[mm]	[mm]	[mm]	10	10	23,5	30	7	50	113	15	10,5	22,5	45	7	70	139	20	15,3	33,5	50	7	80	149	25	16	34	60	8,5	90	178	32	6	37	78	6,5	90	195	40	6	40	98	6,5	110	224	50	6	40	98	6,5	110	224
DN	F	H	J	K	L	M																																																											
[mm]	[mm]	[mm]	[mm]	[mm]	[mm]	[mm]																																																											
10	10	23,5	30	7	50	113																																																											
15	10,5	22,5	45	7	70	139																																																											
20	15,3	33,5	50	7	80	149																																																											
25	16	34	60	8,5	90	178																																																											
32	6	37	78	6,5	90	195																																																											
40	6	40	98	6,5	110	224																																																											
50	6	40	98	6,5	110	224																																																											
	<p><b>Abluftdrossel</b> <i>exhaust air throttle</i></p> <p><b>G1/8</b> <b>G1/4</b></p>																																																																
	<p><b>Schalldämpfer Sinterbronze</b> <i>silencer of sinter bronze casting</i></p> <p><b>G1/8</b> <b>G1/4</b></p>																																																																
	<p><b>5/2-Wege Pilotventil (NAMUR)</b> <b>zum Anflanschen</b> <b>Anschlüsse seitlich</b> <i>5/2-way pilot valve (NAMUR) to flange connections laterally</i></p> <p><b>24V DC</b> <b>230V 50Hz</b></p>																																																																

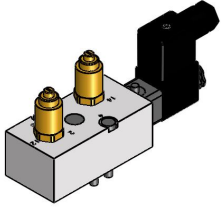
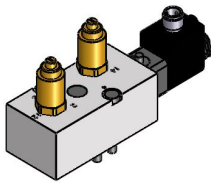
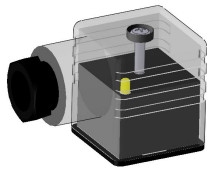
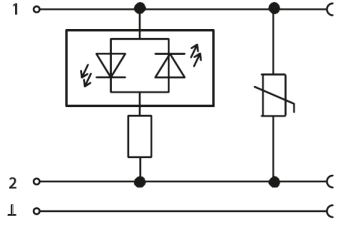
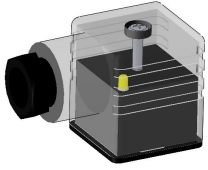
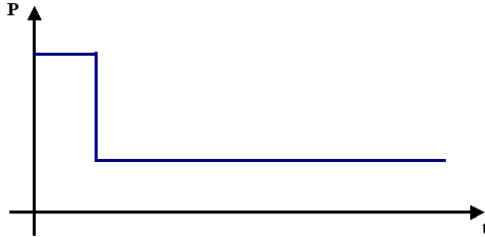
**2/2-Wege Coaxialventil**  
*2/2-way coaxial valve*
**Baureihe 280 / 281 / 282**  
**Type 280 / 281 / 282**

	<p><b>5/2-Wege Pilotventil (NAMUR) zum Anflanschen</b>  <b>Anschlüsse oben</b>  <i>5/2-way pilot valve (NAMUR) to flange connections above</i></p> <p><b>24V DC</b>  <b>230V 50Hz</b></p>	
	<p><b>5/2-Wege Pilotventil (NAMUR) zum Anflanschen</b>  <b>Anschlüsse oben</b>  <b>Magnet M12x1</b>  <i>5/2-way pilot valve (NAMUR) to flange connections above solenoid M12 x 1</i></p> <p><b>24V DC</b>  <b>230V 50Hz</b></p>	
	<p><b>Gerätesteckdose mit LED</b>  <i>plug with LED</i></p> <p><b>elektrische Option = 20</b>  <i>electrical option = 20</i></p>	
	<p><b>Gerätesteckdose mit Leistungsabsenkung</b>  <b>24V DC</b>  <b>Bauform A</b>  <i>plug with power reduction form A</i></p> <p><b>elektrische Option = 07</b>  <i>electrical option = 07</i></p>	
	<p><b>Sonderschutzart</b>  <i>explosion proof</i></p> <p><b>II 2G Ex m II T4</b>  <b>II 3D IP65 T130°C</b></p> <p><b>elektrische Option = 13</b>  <i>electrical option = 13</i></p>	<p><b>der Betriebsdruck ist bei Ex-Ausführung um ca. 20% reduziert</b>  <i>operating pressure is reduced by 20% in Ex specification</i></p>

**2/2-Wege Coaxialventil**  
*2/2-way coaxial valve*
**Baureihe 280 / 281 / 282**  
**Type 280 / 281 / 282**

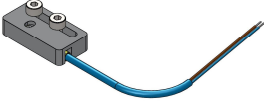
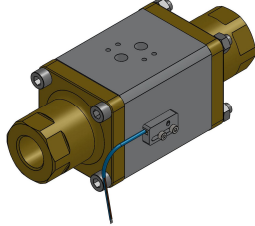
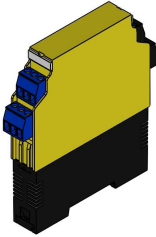
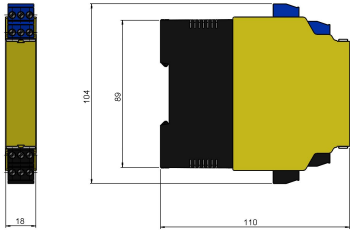
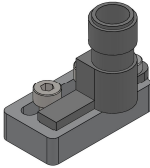
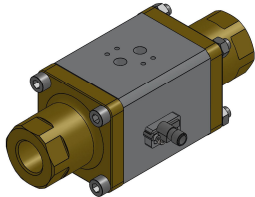
	<p><b>Magnetfeldsensor EX</b> <i>magnetic field sensor EX</i></p> <p><b>KEMA 04 ATEX 1152 X</b> <b>Ex II 1G Ex ia IIC T6</b> <b>Ex II 1D Ex ia IIIC T95°C</b></p> <p><b>elektrische Option = 25</b> <i>electrical option = 25</i></p>	
	<p><b>Trennschaltverstärker</b> <b>2-kanalig</b> <i>isolating switching amplifier</i> <i>2-channel</i></p> <p><b>ATEX: II (1) G, II (1) D; II 3 G</b></p> <p><b>elektrische Option = ?</b> <i>electrical option = ?</i></p>	
	<p><b>Magnetfeldsensor M12x1</b> <i>magnetic field sensor M12x1</i></p> <p><b>elektrische Option = 19</b> <i>electrical option = 19</i></p>	

**Weitere Optionen und Zubehör stimmen wir gerne auf Ihre Anforderungen ab.**  
*We gladly coordinate further options and accessories according to your requirements.*