

1° PARTE / PART 1

RACCORDI PER TUBI SVASATI - 37°

37° - FLARED TUBE CONNECTORS

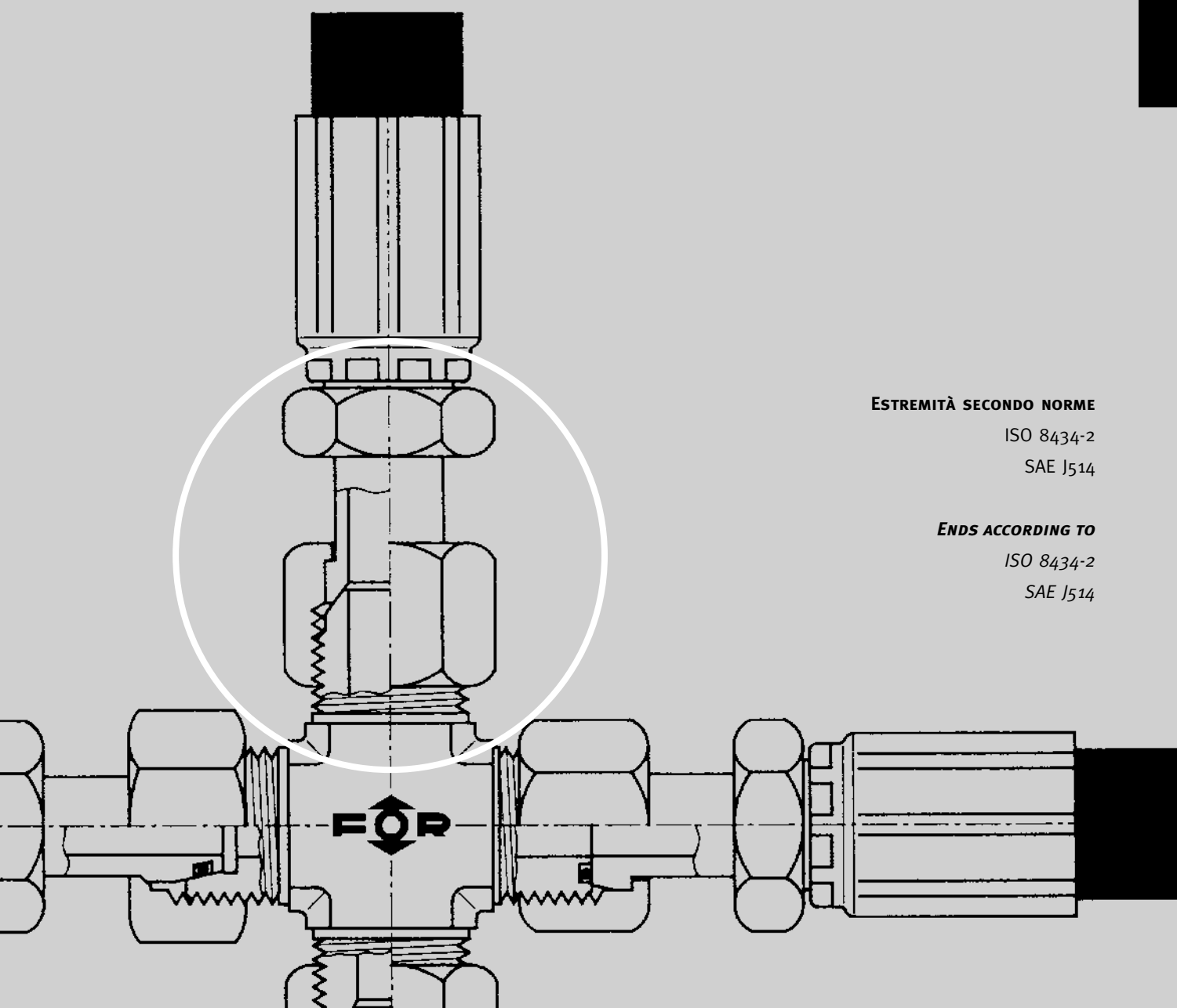

ESTREMITÀ SECONDO NORME

ISO 8434-2

SAE J514

ENDS ACCORDING TO

ISO 8434-2

SAE J514

INDICE FIGURATIVO

VISUAL INDEX

59 101000

Bussola
Sleeve



59 101011

Dado
Nut



60 102001

Giunzione diritta
JIC cono 37° - JIC cono 37°
Union JIC - JIC

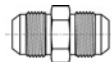

61 102012

Terminale diritto
JIC cono 37° - SAE UNF-UN
per sedi ISO 11926
Connector male JIC - SAE UNF-UN
with O.R. ISO 11926 ports



62 102023

Terminale diritto
JIC cono 37° - GAS cil. (BSPP)
con O.R. e rondella
per sedi ISO 1179
Connector male JIC - BSPP
with O.R. and retaining ring
ISO 1179 ports

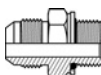

63 102375

Terminale diritto
JIC cono 37° - GAS cil. (JIS)
con O.R. per sedi JIS 2351
Connector male JIC - male JIS
with O.R. JIS 2351 ports



64 102034

Terminale diritto
JIC cono 37° - GAS cil. (BSPP)
con tenuta ad elastomero
per sedi ISO 1179
Connector male JIC - BSPP
with elastomer seal
ISO 1179 ports



65 102067

Terminale diritto
JIC cono 37° - Metrico cil.
con O.R. e rondella
per sedi ISO 9974
Connector male JIC - Metric
with O.R. and retaining ring
ISO 9974 ports



66 102319

Terminale diritto
JIC cono 37° - Metrico cil.
con O.R. per sedi ISO 6149
Connector male JIC - male Metric
with O.R. ISO 6149 ports



67 102078

Terminale diritto
JIC cono 37° - Metrico cil.
con tenuta ad elastomero
per sedi ISO 9974
Connector male JIC - Metric
with elastomer seal
ISO 9974 ports





INDICE FIGURATIVO VISUAL INDEX

68 102166

Terminale diritto femmina
JIC cono 37° - maschio
SAE UNF-UN per sedi ISO 11926
*Connector swivel female
JIC - male SAE UNF-UN
with O.R. ISO 11926 ports*



69 102177

Terminale diritto femmina
JIC cono 37° - maschio
GAS cil. (BSPP) con O.R. e rondella
per sedi ISO 1179
*Connector swivel female
JIC - male BSPP
with O.R. and retaining ring
ISO 1179 ports*



70 102386

Terminale diritto femmina
JIC cono 37° - maschio
GAS cil. (JIS) con O.R.
per sedi JIS 2351
*Connector swivel female
JIC - male JIS
with O.R. JIS 2351 ports*



70 102188

Terminale diritto femmina
JIC cono 37° - maschio
GAS cil. (BSPP) con tenuta
ad elastomero per sedi ISO 1179
*Connector swivel female
JIC - male BSPP
with elastomer seal ISO 1179 ports*

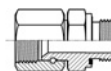

71 102209

Terminale diritto femmina
JIC cono 37° - maschio
Metrico cil. con O.R. e rondella
per sedi ISO 9974
*Connector swivel female
JIC - male Metric
with O.R. and retaining ring
ISO 9974 ports*

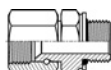

71 102331

Terminale diritto femmina
JIC cono 37° - maschio
Metrico cil. con O.R.
per sedi ISO 6149
*Connector swivel female
JIC - male Metric
with O.R. ISO 6149 ports*

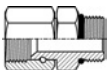

72 102210

Terminale diritto femmina
JIC cono 37° - maschio
Metrico cil. con tenuta
ad elastomero per sedi ISO 9974
*Connector swivel female
JIC - male Metric
with elastomer seal
ISO 9974 ports*

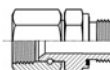

73 102100

Terminale diritto
JIC cono 37° - NPTF
per sedi SAE 476
*Connector male
JIC - NPTF taper SAE 476 ports*

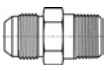

74 102111

Terminale diritto
JIC cono 37° - GAS conico (BSPT)
per sedi ISO 7
*Connector male
JIC - BSPT taper ISO 7 ports*

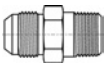

75 102232

Terminale diritto femmina
JIC cono 37° - maschio
NPTF per sedi SAE 476
*Connector swivel female
JIC - male NPTF taper
SAE 476 ports*

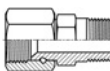

76 102243

Terminale diritto femmina
JIC cono 37° - maschio
GAS conico (BSPT)
per sedi ISO 7
*Connector swivel female
JIC - male BSPT taper
ISO 7 ports*

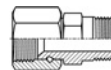

76 102133

Giunzione diretta maschio
JIC cono 37° - femmina NPTF
*Adapter male JIC - female
NPTF taper*

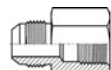

77 102144

Giunzione diretta maschio
JIC cono 37° - femmina
GAS cil. (BSPP)
Adapter male JIC - female BSPP

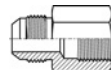

77 102407

Giunzione diretta maschio
JIC cono 37° - femmina JIC cono 37°
e attacco femmina BSPP
per presa di pressione
*Straight union fitting male/female
JIC 37° cone + BSP port for
pressure test point*

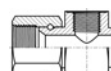

78 102265

Giunzione diretta femmina
JIC cono 37° - maschio
JIC cono 37°
Reducer male - female JIC



INDICE FIGURATIVO

VISUAL INDEX

79 102276

Giunzione diritta maschio
JIC cono 37° - sede a saldare
Braze connector male JIC



80 102287

Giunzione diritta femmina
JIC cono 37° - sede a saldare
Braze connector female JIC

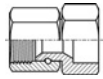

81 102353

Terminale diritto JIC cono 37° -
maschio
GAS cil. (BSPP)
con cono interno 60°
per sedi ISO 8434-6
*Connector male
JIC - male BSPP 60°
ISO 8434-6 ports*

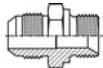

82 102342

Portamanometro maschio
JIC cono 37° - femmina
GAS cil. (BSPP)
*Manometer connector
male JIC - female BSPP*



82 102298

Portamanometro femmina
JIC cono 37° - femmina
GAS cil. (BSPP)
*Manometer connector
female JIC - male BSPP*

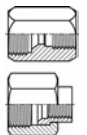

83 101022

Tappo maschio JIC
JIC Male plug



83 101033

Tappo femmina JIC
JIC Female plug



84 103002

Giunzione diritta passaparatia
JIC cono 37° - JIC cono 37°
*Bulkhead union male
JIC - JIC*

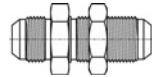

84 103013

Giunzione diritta passaparatia
JIC cono 37° - femmina NPTF
*Bulkhead union male
JIC - female NPTF*

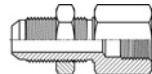

85 104014

Prolunga diritta
JIC cono 37° - SAE UNF-UN
per sedi ISO 11926
*Long connector male
JIC - male SAE UNF-UN
with O.R. ISO 11926 ports*

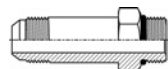

86 104025

Prolunga diritta
JIC cono 37° - GAS cil. (BSPP)
con O.R. e rondella
per sedi ISO 1179
*Long connector male
JIC - male BSPP
with O.R. and retaining ring
ISO 1179 ports*

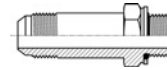

87 104124

Prolunga diritta
JIC cono 37° - GAS cil. (JIS)
con O.R. per sedi JIS 2351
*Long connector male
JIC - male JIS
with O.R. JIS 2351 ports*

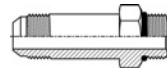

87 104058

Prolunga diritta
JIC cono 37° - Metrico cil.
con O.R. e rondella
per sedi ISO 9974
*Long connector male
JIC - male Metric
with O.R. and retaining ring
ISO 9974 ports*

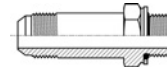

88 104092

Prolunga diritta
JIC cono 37° - Metrico cil.
con O.R. per sedi ISO 6149
*Long connector male
JIC - male Metric
with O.R. ISO 6149 ports*

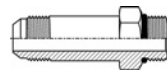

88 105004

Giunzione 45° maschio
JIC cono 37° - femmina
JIC cono 37°
*45° elbow union male
JIC - swivel female JIC*



89 105015

Terminale orientabile 45°
 JIC cono 37° - SAE UNF-UN
 per sedi ISO 11926
 45° (ADJ) elbow male
 JIC - male SAE UNF-UN
 with O.R. ISO 11926 ports

90 105026

Terminale orientabile 45°
 JIC cono 37° - GAS cil. (BSPP)
 con O.R. e rondella per sedi ISO 1179
 45° (ADJ) elbow male JIC - male BSPP
 with O.R. and retaining ring
 ISO 1179 ports

91 105093

Terminale orientabile 45°
 JIC cono 37° - GAS cil. (JIS)
 con O.R. per sedi JIS 2351
 45° (ADJ) elbow male
 JIC - male JIS
 with O.R. JIS 2351 ports

92 105037

Terminale orientabile 45° JIC cono
 37° - Metrico cil. con O.R. e rondella
 per sedi ISO 9974
 45° (ADJ) elbow male JIC - male
 Metric with O.R. and retaining ring
 ISO 9974 ports

93 105082

Terminale orientabile 45°
 JIC cono 37° - Metrico cil.
 con O.R. per sedi ISO 6149
 45° (ADJ) elbow male
 JIC - male Metric
 with O.R. ISO 6149 ports

94 105048

Terminale 45°
 JIC cono 37° - NPTF
 per sedi SAE 476
 45° elbow male
 JIC - male NPTF taper
 SAE 476 ports

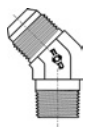
95 105059

Terminale 45°
 JIC cono 37° - GAS conico (BSPT)
 per sedi ISO 7
 45° elbow male
 JIC - male BSPT taper ISO 7 ports

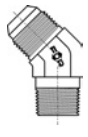
96 106005

Giunzione 45° passaparatia
 JIC cono 37° - JIC cono 37°
 45° bulkhead elbow male
 JIC - JIC

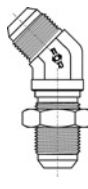
96 107006

Giunzione 90°
 JIC cono 37° - JIC cono 37°
 90° elbow male
 JIC - JIC

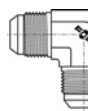
97 107017

Giunzione 90° maschio
 JIC cono 37° - femmina
 JIC cono 37°
 90° elbow male
 JIC - swivel female JIC

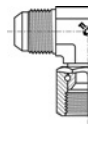
98 107028

Terminale orientabile 90°
 JIC cono 37° - SAE UNF-UN
 per sedi ISO 11926
 90° (ADJ) elbow male JIC - male
 SAE UNF-UN with O.R.
 ISO 11926 ports

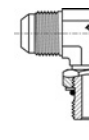
99 107039

Terminale orientabile 90°
 JIC cono 37° - GAS cil. (BSPP)
 con O.R. e rondella per sedi ISO 1179
 90° (ADJ) elbow male JIC - male BSPP
 with O.R. and retaining ring
 ISO 1179 ports

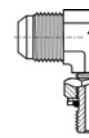
100 107194

Terminale orientabile 90°
 JIC cono 37° - GAS cil. (JIS)
 con O.R. per sedi JIS 2351
 90° (ADJ) elbow male
 JIC - male JIS with O.R. JIS 2351 ports

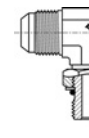
101 107183

Terminale orientabile 90°
 femmina JIC cono 37° - GAS cil.
 (BSPP) con O.R. e rondella
 per sedi ISO 1179
 90° (ADJ) elbow swivel female JIC
 male BSPP with O.R. and retaining
 ring ISO 1179 ports

102 107040

Terminale orientabile 90° JIC cono
 37° - Metrico cil. con O.R. e rondella
 per sedi ISO 9974
 90° (ADJ) elbow male JIC - male
 Metric with O.R. and retaining ring
 ISO 9974 ports

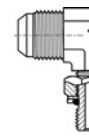

INDICE FIGURATIVO
VISUAL INDEX

103 107161

Terminale orientabile 90°
JIC cono 37° - Metrico cil.
con O.R. per sedi ISO 6149
90° (ADJ) elbow male
JIC - male Metric
with O.R. ISO 6149 ports

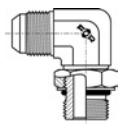

104 107051

Terminale 90°
JIC cono 37° - NPTF
per sedi SAE 476
90° elbow male
JIC - male NPTF
taper SAE 476 ports



105 107062

Terminale 90°
JIC cono 37° - GAS conico (BSPT)
per sedi ISO 7
90° elbow male
JIC - male BSPT
taper ISO 7 ports



106 107084

Giunzione 90°
JIC cono 37° - femmina NPTF
90° elbow male
JIC - female NPTF



106 107095

Giunzione 90°
JIC cono 37° - femmina
Gas cil. (BSPP)
90° elbow male
JIC - female BSPP



107 107116

Giunzione 90° maschio
JIC cono 37° - sede a saldare
90° elbow male
JIC - braze female



107 107127

Giunzione 90° maschio
JIC cono 37° - codolo a saldare
90° elbow male
JIC - butt weld



108 108007

Giunzione 90° passaparatia
JIC cono 37° - JIC cono 37°
90° bulkhead elbow
male JIC - JIC

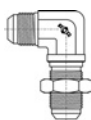

108 109008

Terminale lungo 90°
JIC cono 37° - NPTF
per sedi SAE 476
90° long elbow male
JIC - male NPTF
taper SAE 476 ports

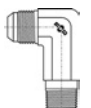

109 110000

Prolunga orientabile 90°
JIC cono 37° - SAE UNF-UN
per sedi ISO 11926
90° (ADJ) long elbow male
JIC - male NPTF
with O.R. ISO 11926 ports

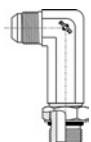

110 110011

Prolunga orientabile 90°
JIC cono 37° - GAS cil. (BSPP)
con O.R. e rondella per sedi ISO 1179
90° (ADJ) long elbow male
JIC - male BSPP with O.R. and
retaining ring nISO 1179 ports

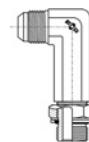

111 110088

Prolunga orientabile 90°
JIC cono 37° - GAS cil. (JIS)
con O.R. per sedi JIS 2351
90° (ADJ) long elbow male
JIC - male JIS
with O.R. JIS 2351 ports

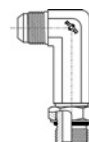

112 110022

Prolunga orientabile 90° JIC cono 37°
- Metrico cil. con O.R. e rondella per
sedi ISO 9974
90° (ADJ) long elbow male JIC - male
Metric ith O.R. and retaining ring
ISO 9974 ports

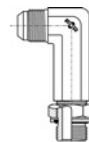

113 110077

Prolunga orientabile 90°
JIC cono 37° - Metrico cil.
con O.R. per sedi ISO 6149
90° (ADJ) long elbow male
JIC - male Metric
with O.R. ISO 6149 ports

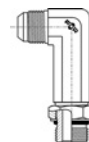

114 110033

Prolunga 90°
JIC cono 37° - NPTF
per sedi SAE 476
90° long elbow male
JIC - male NPTF
taper SAE 476 ports

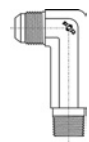



INDICE FIGURATIVO VISUAL INDEX

115 111001

Giunzione a "T" maschi
JIC cono 37°
Union tee male JIC

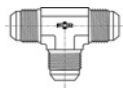

116 111012

Giunzione a "T" maschi
JIC cono 37° - femmina JIC cono 37°
Swivel nut branch tee male JIC

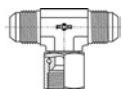

117 111023

Terminale orientabile a "T"
JIC cono 37° - SAE UNF-UN
per sedi ISO 11926
*Branch (ADJ) tee male
JIC - male SAE UNF-UN
with O.R. ISO 11926 ports*

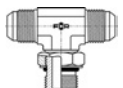

118 111034

Terminale orientabile a "T"
JIC cono 37° - GAS cil. (BSPP)
con O.R. e rondella
per sedi ISO 1179
*Branch (ADJ) tee male
JIC - male BSPP
with O.R. and retaining ring
ISO 1179 ports*

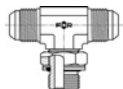

119 111166

Terminale orientabile a "T"
JIC cono 37° - GAS cil. (JIS)
con O.R. per sedi JIS 2351
*Branch (ADJ) tee male
JIC - male JIS
with O.R. JIS 2351 ports*

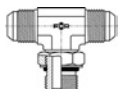

120 111045

Terminale orientabile a "T"
JIC cono 37° - Metrico cil.
con O.R. e rondella
per sedi ISO 9974
*Branch (ADJ) tee male
JIC - male Metric
with O.R. and retaining ring
ISO 9974 ports*

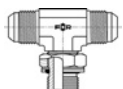

121 111122

Terminale orientabile a "T"
JIC cono 37° - Metrico cil.
con O.R. per sedi ISO 6149
*Branch (ADJ) tee male
JIC - male Metric
with O.R. ISO 6149 ports*

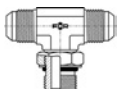

121 111056

Terminale a "T"
JIC cono 37° - NPTF
per sedi SAE 476
*Branch tee male
JIC - male NPTF
taper ISO 476 ports*

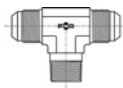

122 111067

Terminale a "T"
JIC cono 37° - GAS conico (BSPT)
per sedi ISO 7
*Branch tee male
JIC - male BSPT
taper ISO 7 ports*

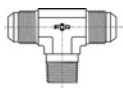

122 111089

Giunzione a "T" maschi
JIC cono 37° - femmina NPTF
*Branch tee male
JIC - female NPTF*

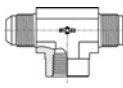

123 111090

Giunzione a "T" maschi
JIC cono 37° - femmina
GAS cil. (BSPP)
*Branch tee male
JIC - female BSPP*

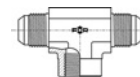

123 112002

Giunzione a "T" passaparatia
maschi JIC cono 37°
Bulkhead branch tee male JIC

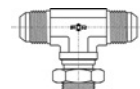

124 113003

Giunzione a "L" maschi
JIC cono 37° - femmina
JIC cono 37°
*Swivel nut run tee male
JIC - female JIC*

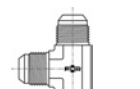

125 113014

Terminale orientabile a "L"
JIC cono 37° - SAE UNF-UN
per sedi ISO 11926
*Run (ADJ) tee male
JIC - male SAE UNF-UN
with O.R. ISO 11926 ports*

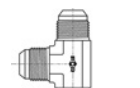

126 113025

Terminale orientabile a "L"
JIC cono 37° - GAS cil. (BSPP)
con O.R. e rondella per sedi ISO 1179
*Run (ADJ) tee male
JIC - male BSPP with O.R.
and retaining ring ISO 1179 ports*

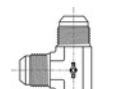

INDICE FIGURATIVO
VISUAL INDEX

127 113135

Terminale orientabile ad "L"
JIC cono 37° - GAS cil. (JIS)
con O.R. per sedi JIS 2351
Run (ADJ) tee male
JIC - male JIS
with O.R. JIS 2351 ports

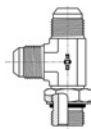

128 113036

Terminale orientabile a "L"
JIC cono 37° - Metrico cil.
con O.R. e rondella
per sedi ISO 9974
Run (ADJ) tee male JIC - male Metric
with O.R. and retaining ring
ISO 9974 ports

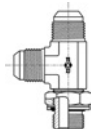

129 113113

Terminale orientabile ad "L"
JIC cono 37° - Metrico cil. con O.R.
per sedi ISO 6149
Run (ADJ) tee male
JIC - male Metric
with O.R. ISO 6149

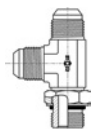

130 113047

Terminale a "L"
JIC cono 37° - NPTF
per sedi SAE 476
Run tee male
JIC - male NPTF
taper SAE 476 ports

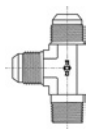

131 113058

Terminale a "L"
JIC cono 37° - GAS conico (BSPT)
per sedi ISO 7
Run tee male
JIC - male BSPT
taper ISO 7 ports

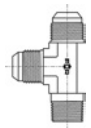

131 113070

Giunzione a "L" maschi
JIC cono 37° - femmina NPTF
Run tee male
JIC - female NPTF

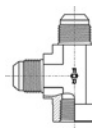

132 113081

Giunzione a "L" maschi
JIC cono 37° - femmina
GAS cil. (BSPP)
Run tee male
JIC - female BSPP

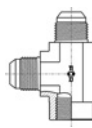

133 114004

Giunzione a "L" passaparatia
maschi JIC cono 37°
Bulkhead run tee male JIC

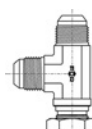

133 115005

Giunzione a croce maschi
JIC cono 37°
Union cross male JIC

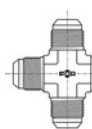

134 402008

Flangia diritta maschio
JIC cono 37° - SAE 3000 PSI
Straight male
JIC - SAE 3000 PSI flange

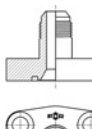

134 402503

Flangia diritta maschio
JIC cono 37° - SAE 6000 PSI
Straight male
JIC - SAE 6000 PSI flange

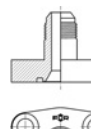

135 407035

Flangia 90° maschio
JIC cono 37° - SAE 3000 PSI
90° male
JIC - SAE 3000 PSI flange

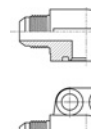

135 407530

Flangia 90° maschio
JIC cono 37° - SAE 6000 PSI
90° male
JIC - SAE 6000 PSI flange

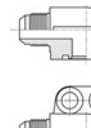

136 405001

Flangia 45° orientabile maschio
JIC cono 37° - SAE 3000 PSI
45° (ADJ) male
JIC - SAE 3000 PSI flange

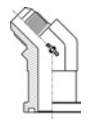

136 405506

Flangia 45° orientabile maschio
JIC cono 37° - SAE 6000 PSI
45° (ADJ) male
JIC - SAE 6000 PSI flange

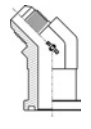

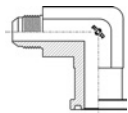

137 407002

Flangia 90° orientabile maschio
 JIC cono 37° - SAE 3000 PSI
 90° (ADJ) male
 JIC - SAE 3000 PSI flange

137 407507

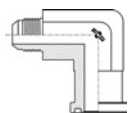
Flangia 90° orientabile maschio
 JIC cono 37° - SAE 6000 PSI
 90° (ADJ) male
 JIC - SAE 6000 PSI flange

138 411006

Flangia a "T" orientabile
 maschi JIC cono 37° - SAE 3000 PSI
 Branch (ADJ) tee male
 JIC - SAE 3000 PSI flange

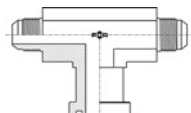
138 411501

Flangia a "T" orientabile maschi
 JIC cono 37° - SAE 6000 PSI
 Branch (ADJ) tee male
 JIC - SAE 6000 PSI flange

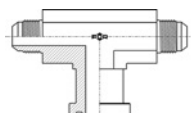
139 413008

Flangia a "L" orientabile maschi
 JIC cono 37° - SAE 3000 PSI
 Run (ADJ) tee male
 JIC - SAE 3000 PSI flange

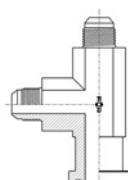
139 413503

Flangia a "L" orientabile maschi
 JIC cono 37° - SAE 6000 PSI
 Run (ADJ) tee male
 JIC - SAE 6000 PSI flange

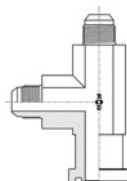
140 402130

Flangia diritta maschio
 JIC cono 37° - interasse metrico
 4 fori per viti standard
 Straight male
 JIC - 4 bolts metric flange std. screw

140 402131

Flangia diritta maschio
 JIC cono 37° - interasse metrico
 4 fori per viti maggiorate
 Straight male
 JIC - 4 bolts metric flange heavy screw

141 407123

Flangia 90° maschio
 JIC cono 37° - interasse metrico
 3 fori per viti standard
 90° male JIC - 3 bolts metric
 flange std. screw

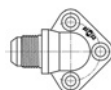
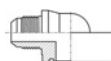
141 407124

Flangia 90° maschio
 JIC cono 37° - interasse metrico
 3 fori per viti maggiorate
 90° male JIC - 3 bolts metric
 flange heavy screw

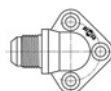
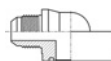

142 407167

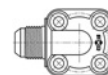
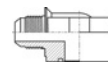
Flangia 90° maschio
 JIC cono 37° - interasse metrico
 4 fori per viti standard
 90° male JIC - 4 bolts metric
 flange std. screw

142 407168

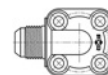
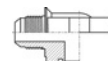
Flangia 90° maschio
 JIC cono 37° - interasse metrico
 4 fori per viti maggiorate
 90° male JIC - 4 bolts metric
 flange heavy screw

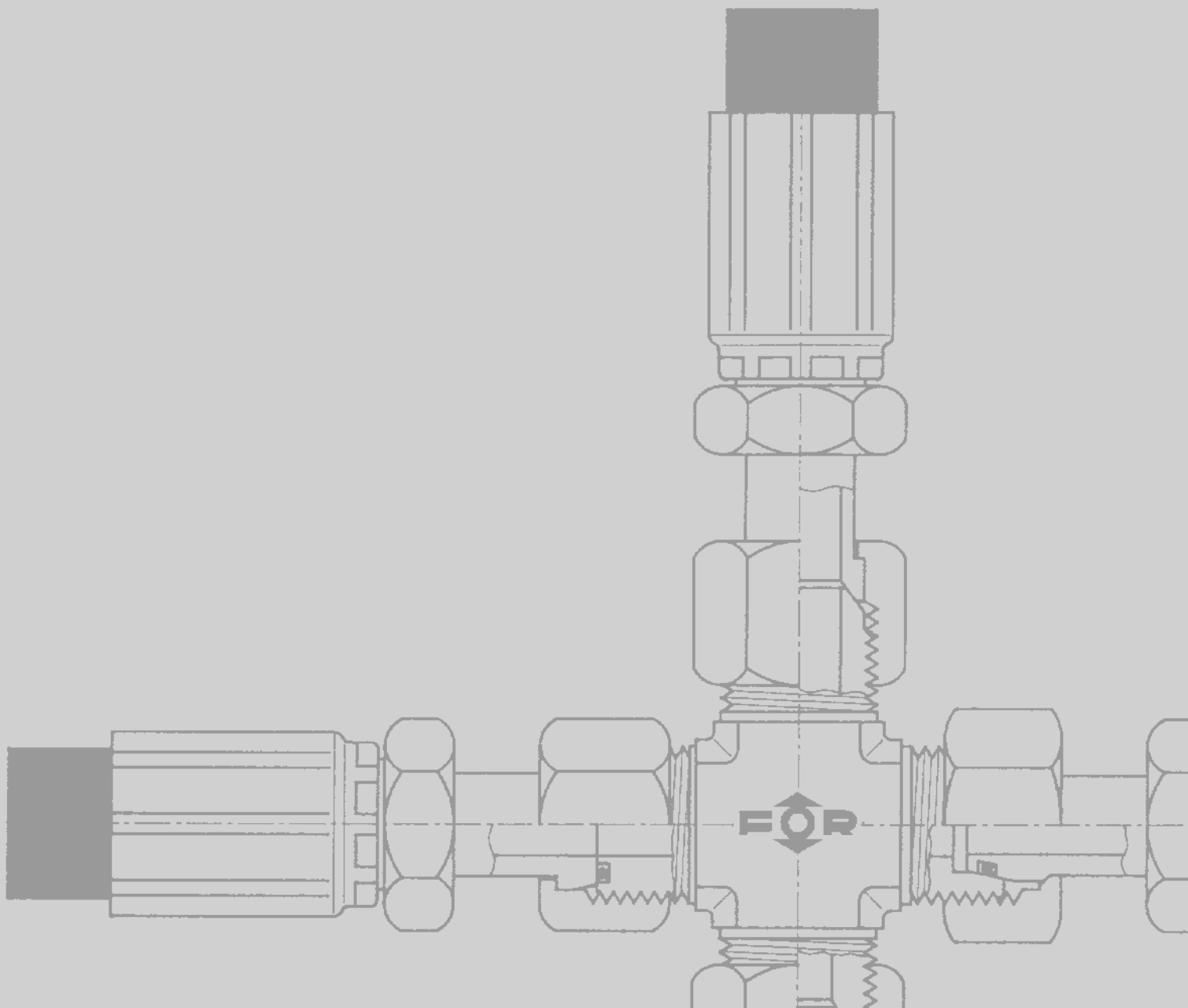





101000

Bussola
Sleeve

T	RIFERIMENTO REFERENCE	A
MM.		
6	A101000/06	10,5
8	A101000/08	11,5
10	A101000/10	12,5
12	A101000/12	14,5
14	A101000/14	16,5
15	A101000/15	16,5
16	A101000/16	16,5
18	A101000/18	17
20	A101000/20	17
22	A101000/22	19
25	A101000/25	19,5
28	A101000/28	21
30	A101000/30	23
32	A101000/32	23
38	A101000/38	28,5
50	A101000/50	30

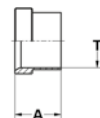

101011

Dado
Nut

T	RIFERIMENTO REFERENCE	J	A	CH
MM.		UNF-UN		
6	A101011/06	7/16-20	15,5	14
8	A101011/08	1/2-20	17	17
10	A101011/10	9/16-18	18,5	17
10	A101011/1019	9/16-18	18,5	19
12	A101011/12	3/4-16	21,5	22
14÷16	A101011/16	7/8-14	24,5	27
18-20	A101011/18	1" 1/16-12	26	32
18-20	A101011/20	1" 1/16-12	26	32
22	A101011/22	1" 3/16-12	27,5	36
25	A101011/25	1" 5/16-12	28,5	38
25	A101011/2541	1" 5/16-12	28,5	41
30-32	A101011/32	1" 5/8-12	31	50
38	A101011/38	1" 7/8-12	36	57
38	A101011/3860	1" 7/8-12	36	60
50	A101011/50	2" 1/2-12	44,5	75

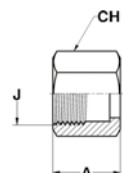

RACCORDI PER TUBI SVASATI - 37°

37° - FLARED TUBE CONNECTORS

102001

Giunzione diretta
JIC cono 37° - JIC cono 37°
Union JIC - JIC

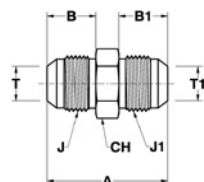

T		T ₁		RIFERIMENTO REFERENCE	J	J ₁	A	B	B ₁	CH
MM.	IN.	MM.	IN.		UNF-UN	UNF-UN				
6	1/4	6	1/4	A102001/06	7/16-20	7/16-20	35	14	14	13
8	5/16	8	5/16	A102001/08	1/2-20	1/2-20	35	14	14	14
10	3/8	10	3/8	A102001/10	9/16-18	9/16-18	36	14	14	16
12	1/2	12	1/2	A102001/12	3/4-16	3/4-16	41	17	17	21
14÷16	5/8	14÷16	5/8	A102001/16	7/8-14	7/8-14	48	19,5	19,5	24
18-20	3/4	18-20	3/4	A102001/20	1" 1/16-12	1" 1/16-12	55	22	22	30
22	7/8	22	7/8	A102001/22	1" 3/16-12	1" 3/16-12	56	22,5	22,5	32
25	1"	25	1"	A102001/25	1" 5/16-12	1" 5/16-12	57	23	23	35
30-32	1" 1/4	30-32	1" 1/4	A102001/32	1" 5/8-12	1" 5/8-12	61,5	24,5	24,5	42
38	1" 1/2	38	1" 1/2	A102001/38	1" 7/8-12	1" 7/8-12	70	27,5	27,5	50
8	5/16	6	1/4	SA102001/0806	1/2-20	7/16-20	35	14	14	14
10	3/8	6	1/4	SA102001/1006	9/16-18	7/16-20	35,5	14	14	16
10	3/8	8	5/16	SA102001/1008	9/16-18	1/2-20	35,5	14	14	16
12	1/2	6	1/4	SA102001/1206	3/4-16	7/16-20	39	17	14	21
12	1/2	8	5/16	SA102001/1208	3/4-16	1/2-20	38,5	17	14	21
12	1/2	10	3/8	SA102001/1210	3/4-16	9/16-18	39	17	14	21
14÷16	5/8	8	5/16	SA102001/1608	7/8-14	1/2-20	42,5	19,5	14	24
14÷16	5/8	10	3/8	SA102001/1610	7/8-14	9/16-18	42	19,5	14	24
14÷16	5/8	12	1/2	SA102001/1612	7/8-14	3/4-16	45	19,5	17	24
18-20	3/4	10	3/8	SA102001/2010	1" 1/16-12	9/16-18	47	22	14	30
18-20	3/4	12	1/2	SA102001/2012	1" 1/16-12	3/4-16	50	22	17	30
18-20	3/4	14÷16	5/8	SA102001/2016	1" 1/16-12	7/8-14	52,5	22	19,5	30
22	7/8	14÷16	5/8	SA102001/2216	1" 3/16-12	7/8-14	53	22,5	19,5	32
22	7/8	18-20	3/4	SA102001/2220	1" 3/16-12	1" 1/16-12	55,5	22,5	22	32
25	1"	8	5/16	SA102001/2508	1" 5/16-12	1/2-20	48	23	14	35
25	1"	14÷16	5/8	SA102001/2516	1" 5/16-12	7/8-14	53,5	23	19,5	35
25	1"	18-20	3/4	SA102001/2520	1" 5/16-12	1" 1/16-12	56	23	22	35
25	1"	22	7/8	SA102001/2522	1" 5/16-12	1" 3/16-12	57	23	22,5	35
30-32	1" 1/4	22	7/8	SA102001/3222	1" 5/8-12	1" 3/16-12	60	24,5	22,5	42
30-32	1" 1/4	25	1"	SA102001/3225	1" 5/8-12	1" 5/16-12	60,5	24,5	23	42
38	1" 1/2	30-32	1" 1/4	SA102001/3832	1" 7/8-12	1" 5/8-12	65,5	27,5	24,5	50
50	2"	50	2"	SA102001/50	2" 1/2-12	2" 1/2-12	86,5	34	34	70



102012

T		RIFERIMENTO REFERENCE	J	F	A	B	D	CH
MM.	IN.		UNF-UN	UNF-UN				
6	1/4	A102012/0611	7/16-20	7/16-20	31	14	9	14
6	1/4	A102012/0612	7/16-20	1/2-20	31	14	9	16
6	1/4	A102012/0614	7/16-20	9/16-18	32,5	14	10	19
8	5/16	A102012/0812	1/2-20	1/2-20	31	14	9	16
10	3/8	A102012/1014	9/16-18	9/16-18	33	14	10	19
10	3/8	A102012/1019	9/16-18	3/4-16	35	14	11	22
12	1/2	A102012/1219	3/4-16	3/4-16	37,5	17	11	22
12	1/2	A102012/1222	3/4-16	7/8-14	40,5	17	13	27
12	1/2	A102012/1227	3/4-16	1"1/16-12	44,5	17	15	32
14÷16	5/8	A102012/1619	7/8-14	3/4-16	40,5	19,5	11	24
14÷16	5/8	A102012/1622	7/8-14	7/8-14	43	19,5	13	27
14÷16	5/8	A102012/1627	7/8-14	1"1/16-12	47	19,5	15	32
18-20	3/4	A102012/2019	1"1/16-12	3/4-16	44,5	22	11	27
18-20	3/4	A102012/2022	1"1/16-12	7/8-14	47	22	13	27
18-20	3/4	A102012/2027	1"1/16-12	1"1/16-12	50	22	15	32
18-20	3/4	A102012/2033	1"1/16-12	1"5/16-12	50,5	22	15	38
22	7/8	A102012/2230	1"3/16-12	1"3/16-12	50,5	22,5	15	35
25	1"	A102012/2527	1"5/16-12	1"1/16-12	50,5	23	15	35
25	1"	A102012/2533	1"5/16-12	1"5/16-12	52	23	15	38
25	1"	A102012/2541	1"5/16-12	1"5/8-12	54	23	15	48
30-32	1"1/4	A102012/3241	1"5/8-12	1"5/8-12	55	24,5	15	48
38	1"1/2	A102012/3848	1"7/8-12	1"7/8-12	60	27,5	15	55
6	1/4	SA102012/0609	7/16-20	3/8-24	30	14	7,5	13
6	1/4	SA102012/0619	7/16-20	3/4-16	35	14	11	22
8	5/16	SA102012/0811	1/2-20	7/16-20	31	14	9	14
8	5/16	SA102012/0814	1/2-20	9/16-18	33	14	10	19
8	5/16	SA102012/0819	1/2-20	3/4-16	35	14	11	22
10	3/8	SA102012/1009	9/16-18	3/8-24	31	14	7,5	16
10	3/8	SA102012/1011	9/16-18	7/16-20	32,5	14	9	16
10	3/8	SA102012/1012	9/16-18	1/2-20	32,5	14	9	16
10	3/8	SA102012/1022	9/16-18	7/8-14	37,5	14	13	27
12	1/2	SA102012/1211	3/4-16	7/16-20	35	17	9	22
12	1/2	SA102012/1214	3/4-16	9/16-18	35	17	10	22
14÷16	5/8	SA102012/1612	7/8-14	1/2-20	38,5	19,5	9	24
14÷16	5/8	SA102012/1614	7/8-14	9/16-18	38,5	19,5	10	24
14÷16	5/8	SA102012/1630	7/8-14	1"3/16-12	47	19,5	15	35
14÷16	5/8	SA102012/1633	7/8-14	1"5/16-12	48	19,5	15	38
18-20	3/4	SA102012/2030	1"1/16-12	1"3/16-12	50	22	15	35
22	7/8	SA102012/2227	1"3/16-12	1"1/16-12	49,5	22,5	15	35
22	7/8	SA102012/2233	1"3/16-12	1"5/16-12	51,5	22,5	15	38
25	1"	SA102012/2519	1"5/16-12	3/4-16	47,5	23	11	36
25	1"	SA102012/2522	1"5/16-12	7/8-14	48	23	13	35
25	1"	SA102012/2530	1"5/16-12	1"3/16-12	51,5	23	15	35
30-32	1"1/4	SA102012/3227	1"5/8-12	1"1/16-12	53	24,5	15	42
30-32	1"1/4	SA102012/3233	1"5/8-12	1"5/16-12	53	24,5	15	42
30-32	1"1/4	SA102012/3248	1"5/8-12	1"7/8-12	56,5	24,5	15	55
38	1"1/2	SA102012/3841	1"7/8-12	1"5/8-12	64,5	27,5	15	50
38	1"1/2	SA102012/3863	1"7/8-12	2"1/2-12	64	27,5	15	70
50	2"	SA102012/5063	2"1/2-12	2"1/2-12	70,5	34	15	70

Terminale dritto
JIC cono 37° - SAE UNF-UN
per sedi ISO 11926
Connector male JIC - SAE UNF-UN
with O.R. ISO 11926 ports
SEDI PAG.30 / PORTS PAG.30

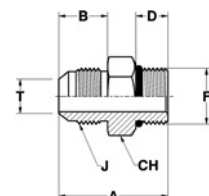

RACCORDI PER TUBI SVASATI - 37°

37° - FLARED TUBE CONNECTORS

102023

Terminale dritto
JIC cono 37° - GAS cil. (BSPP)
con O.R. e rondella
per sedi ISO 1179
Connector male JIC - BSPP
with O.R. and retaining ring
ISO 1179 ports

SEDI PAG.32 / PORTS PAG.32

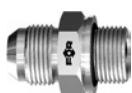
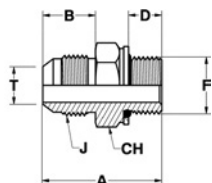

T		RIFERIMENTO REFERENCE	J	F	A	B	D	CH
MM.	IN.		UNF-UN	GAS CIL-BSPP				
6	1/4	A102023/0610	7/16-20	1/8	29	14	7	14
6	1/4	A102023/0613	7/16-20	1/4	34.5	14	10	19
6	1/4	A102023/0617	7/16-20	3/8	34.5	14	10	24
6	1/4	A102023/0621	7/16-20	1/2	38	14	12	27
8	5/16	A102023/0810	1/2-20	1/8	29	14	7	14
8	5/16	A102023/0813	1/2-20	1/4	34.5	14	10	19
8	5/16	A102023/0817	1/2-20	3/8	34.5	14	10	24
10	3/8	A102023/1013	9/16-18	1/4	34.5	14	10	19
10	3/8	A102023/1017	9/16-18	3/8	34.5	14	10	24
10	3/8	A102023/1021	9/16-18	1/2	38	14	12	27
12	1/2	A102023/1213	3/4-16	1/4	37.5	17	10	22
12	1/2	A102023/1217	3/4-16	3/8	37.5	17	10	24
12	1/2	A102023/1221	3/4-16	1/2	41	17	12	27
12	1/2	A102023/1226	3/4-16	3/4	45	17	14	36
14÷16	5/8	A102023/1617	7/8-14	3/8	40.5	19,5	10	24
14÷16	5/8	A102023/1621	7/8-14	1/2	43.5	19,5	12	27
14÷16	5/8	A102023/1626	7/8-14	3/4	47.5	19,5	14	36
18-20	3/4	A102023/2021	1" 1/16-12	1/2	47	22	12	30
18-20	3/4	A102023/2026	1" 1/16-12	3/4	50	22	14	36
18-20	3/4	A102023/2033	1" 1/16-12	1"	52.5	22	15,5	41
22	7/8	A102023/2226	1" 3/16-12	3/4	50.5	22,5	14	36
25	1"	A102023/2526	1" 5/16-12	3/4	51	23	14	36
25	1"	A102023/2533	1" 5/16-12	1"	53.5	23	15,5	41
25	1"	A102023/2542	1" 5/16-12	1" 1/4	57	23	17,5	50
30-32	1" 1/4	A102023/3233	1" 5/8-12	1"	55.5	24,5	15,5	42
30-32	1" 1/4	A102023/3242	1" 5/8-12	1" 1/4	58.5	24,5	17,5	50
38	1" 1/2	A102023/3842	1" 7/8-12	1" 1/4	61.5	27,5	17,5	50
38	1" 1/2	A102023/3848	1" 7/8-12	1" 1/2	65.5	27,5	19,5	60
8	5/16	SA102023/0821	1/2-20	1/2	38	14	14	27
8	5/16	SA102023/0826	1/2-20	3/4	42	14	14	36
10	3/8	SA102023/1010	9/16-18	1/8	29	14	7	17
10	3/8	SA102023/1026	9/16-18	3/4	42	14	14	36
10	3/8	SA102023/1033	9/16-18	1"	44.5	14	15,5	41
12	1/2	SA102023/1210	3/4-16	1/8	33.5	17	7	22
12	1/2	SA102023/1233	3/4-16	1"	47	17	15,5	41
14÷16	5/8	SA102023/1613	7/8-14	1/4	40.5	19,5	10	24
14÷16	5/8	SA102023/1633	7/8-14	1"	50	19,5	15,5	41
14÷16	5/8	SA102023/1642	7/8-14	1" 1/4	53.5	19,5	17,5	50
18-20	3/4	SA102023/2017	1" 1/16-12	3/8	45	22	10	27
18-20	3/4	SA102023/2023	1" 1/16-12	5/8	47	22	14	30
18-20	3/4	SA102023/2042	1" 1/16-12	1" 1/4	56	22	17,5	50
18-20	3/4	SA102023/2048	1" 1/16-12	1" 1/2	60	22	19,5	60
22	7/8	SA102023/2221	1" 3/16-12	1/2	48.5	22,5	14	32
22	7/8	SA102023/2233	1" 3/16-12	1"	53	22,5	15,5	41
22	7/8	SA102023/2242	1" 3/16-12	1" 1/4	56.5	22,5	17,5	50
25	1"	SA102023/2521	1" 5/16-12	1/2	49	23	14	36
25	1"	SA102023/2548	1" 5/16-12	1" 1/2	61	23	19,5	60
30-32	1" 1/4	SA102023/3226	1" 5/8-12	3/4	53	24,5	14	42
30-32	1" 1/4	SA102023/3248	1" 5/8-12	1" 1/2	62.5	24,5	19,5	60
38	1" 1/2	SA102023/3833	1" 7/8-12	1"	59.5	27,5	15,5	50

FOR S.P.A. - NORME E DIMENSIONI SOGGETTE A MODIFICHE SENZA PREAVVISO.
FOR S.P.A. - DESIGN DETAILS AND SPECIFICATIONS SUBJECT TO CHANGE WITHOUT PRIOR NOTICE.



102375

T		RIFERIMENTO REFERENCE	J	F	A	B	D	CH
MM.	IN.		UNF-UN	GAS CIL-JIS				
6	1/4	A102375/0610	7/16-20	1/8	30	14	9	14
6	1/4	A102375/0613	7/16-20	1/4	34,5	14	12	19
6	1/4	A102375/0617	7/16-20	3/8	34,5	14	12	22
6	1/4	A102375/0621	7/16-20	1/2	40	14	16	27
8	5/16	A102375/0810	1/2-20	1/8	30	14	9	14
8	5/16	A102375/0813	1/2-20	1/4	34,5	14	12	19
8	5/16	A102375/0817	1/2-20	3/8	34,5	14	12	22
10	3/8	A102375/1013	9/16-18	1/4	34,5	14	12	19
10	3/8	A102375/1017	9/16-18	3/8	34,5	14	12	22
10	3/8	A102375/1021	9/16-18	1/2	40	14	16	27
12	1/2	A102375/1213	3/4-16	1/4	37,5	17	12	22
12	1/2	A102375/1217	3/4-16	3/8	37,5	17	12	22
12	1/2	A102375/1221	3/4-16	1/2	43	17	16	27
12	1/2	A102375/1226	3/4-16	3/4	46	17	17	36
14÷16	5/8	A102375/1617	7/8-14	3/8	40,5	19,5	12	24
14÷16	5/8	A102375/1621	7/8-14	1/2	45,5	19,5	16	27
14÷16	5/8	A102375/1626	7/8-14	3/4	48,5	19,5	17	36
18-20	3/4	A102375/2021	1" 1/16-12	1/2	49	22	16	30
18-20	3/4	A102375/2026	1" 1/16-12	3/4	51	22	17	36
18-20	3/4	A102375/2033	1" 1/16-12	1"	54,5	22	20	41
22	7/8	A102375/2226	1" 3/16-12	3/4	51,5	22,5	17	36
25	1"	A102375/2526	1" 5/16-12	3/4	52	23	17	36
25	1"	A102375/2533	1" 5/16-12	1"	55,5	23	20	41
25	1"	A102375/2542	1" 5/16-12	1" 1/4	57	23	20	50
30-32	1" 1/4	A102375/3233	1" 5/8-12	1"	57,5	24,5	20	42
30-32	1" 1/4	A102375/3242	1" 5/8-12	1" 1/4	58,5	24,5	20	50
38	1" 1/2	A102375/3842	1" 7/8-12	1" 1/4	61,5	27,5	20	50
38	1" 1/2	A102375/3848	1" 7/8-12	1" 1/2	63,5	27,5	20	55

Terminale diritto
JIC cono 37° - GAS cil. (JIS)
con O.R. per sedi JIS 2351
Connector male JIC - male JIS
with O.R. JIS 2351 ports
SEDI PAG.31 / PORTS PAG.31

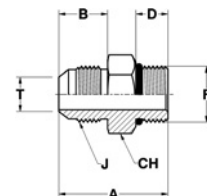

RACCORDI PER TUBI SVASATI - 37°

37° - FLARED TUBE CONNECTORS

102034

Terminale dritto
JIC cono 37° - GAS cil. (BSPP)
con tenuta ad elastomero
per sedi ISO 1179
Connector male JIC - BSPP
with elastomer seal
ISO 1179 ports

SEDI PAG.34 / PORTS PAG.34

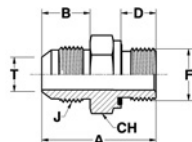

T		RIFERIMENTO REFERENCE	J	F	A	B	D	CH
MM.	IN.		UNF-UN	GAS CIL-BSPP				
6	1/4	A102034/0610	7/16-20	1/8	30	14	8	14
6	1/4	A102034/0613	7/16-20	1/4	36.5	14	12	19
8	5/16	A102034/0813	1/2-20	1/4	36.5	14	12	19
8	5/16	A102034/0817	1/2-20	3/8	36.5	14	12	22
10	3/8	A102034/1013	9/16-18	1/4	36.5	14	12	19
10	3/8	A102034/1017	9/16-18	3/8	36.5	14	12	22
12	1/2	A102034/1217	3/4-16	3/8	39.5	17	12	22
12	1/2	A102034/1221	3/4-16	1/2	43	17	14	27
12	1/2	A102034/1226	3/4-16	3/4	47	17	16	32
14÷16	5/8	A102034/1617	7/8-14	3/8	42.5	19,5	12	24
14÷16	5/8	A102034/1621	7/8-14	1/2	45.5	19,5	14	27
14÷16	5/8	A102034/1626	7/8-14	3/4	49.5	19,5	16	32
18-20	3/4	A102034/2021	1" 1/16-12	1/2	49	22	14	27
18-20	3/4	A102034/2026	1" 1/16-12	3/4	52	22	16	32
18-20	3/4	A102034/2033	1" 1/16-12	1"	55	22	18	41
25	1"	A102034/2526	1" 5/16-12	3/4	53	23	16	36
25	1"	A102034/2533	1" 5/16-12	1"	56	23	18	41
25	1"	A102034/2542	1" 5/16-12	1" 1/4	59.5	23	20	50
30-32	1" 1/4	A102034/3233	1" 5/8-12	1"	58	24,5	18	46
30-32	1" 1/4	A102034/3242	1" 5/8-12	1" 1/4	61	24,5	20	50
38	1" 1/2	A102034/3842	1" 7/8-12	1" 1/4	66	27,5	20	50
38	1" 1/2	A102034/3848	1" 7/8-12	1" 1/2	68	27,5	22	55
6	1/4	SA102034/0617	7/16-20	3/8	36.5	14	12	22
6	1/4	SA102034/0621	7/16-20	1/2	40	14	14	27
10	3/8	SA102034/1021	9/16-18	1/2	39	14	14	27
12	1/2	SA102034/1213	3/4-16	1/4	39.5	17	12	19
12	1/2	SA102034/1248	3/4-16	1" 1/2	55	17	22	55
18-20	3/4	SA102034/2048	1" 1/16-12	1" 1/2	62.5	22	22	55



T		RIFERIMENTO REFERENCE	J	F	A	B	D	CH
MM.	IN.		UNF-UN	METRICO METRIC				
6	1/4	A102067/0610	7/16-20	10x1	30	14	8,5	14
6	1/4	A102067/0612	7/16-20	12x1,5	33	14	9,5	17
8	5/16	A102067/0810	1/2-20	10x1	30	14	8,5	14
8	5/16	A102067/0812	1/2-20	12x1,5	33	14	9,5	17
8	5/16	A102067/0814	1/2-20	14x1,5	34	14	9,5	19
10	3/8	A102067/1014	9/16-18	14x1,5	34	14	9,5	19
10	3/8	A102067/1016	9/16-18	16x1,5	35	14	11	22
12	1/2	A102067/1216	3/4-16	16x1,5	38	17	11	22
12	1/2	A102067/1218	3/4-16	18x1,5	39,5	17	12,5	24
14÷16	5/8	A102067/1618	7/8-14	18x1,5	42	19,5	12,5	24
14÷16	5/8	A102067/1620	7/8-14	20x1,5	43	19,5	12,5	27
14÷16	5/8	A102067/1622	7/8-14	22x1,5	44,5	19,5	13,5	27
18-20	3/4	A102067/2022	1" 1/16-12	22x1,5	48	22	13,5	30
18-20	3/4	A102067/2027	1" 1/16-12	27x2	52	22	16,5	32
22	7/8	A102067/2226	1" 3/16-12	26x1,5	49	22,5	14	36
25	1"	A102067/2527	1" 5/16-12	27x2	53	23	16,5	36
25	1"	A102067/2533	1" 5/16-12	33x2	54	23	16,5	41
30-32	1" 1/4	A102067/3242	1" 5/8-12	42x2	58	24,5	17	50
38	1" 1/2	A102067/3848	1" 7/8-12	48x2	65,5	27,5	19,5	55
6	1/4	SA102067/0614	7/16-20	14x1,5	34	14	9,5	19
6	1/4	SA102067/0616	7/16-20	16x1,5	35	14	11	22
6	1/4	SA102067/0618	7/16-20	18x1,5	36,5	14	12,5	24
6	1/4	SA102067/0622	7/16-20	22x1,5	39	14	13,5	27
6	1/4	SA102067/0627	7/16-20	27x2	44	14	16,5	32
8	5/16	SA102067/0818	1/2-20	18x1,5	37,5	14	12,5	24
8	5/16	SA102067/0822	1/2-20	22x1,5	38,5	14	13,5	27
10	3/8	SA102067/1010	9/16-18	10x1	32	14	8,5	17
10	3/8	SA102067/1012	9/16-18	12x1,5	34,5	14	9,5	17
10	3/8	SA102067/1018	9/16-18	18x1,5	37,5	14	12,5	24
10	3/8	SA102067/1022	9/16-18	22x1,5	38,5	14	13,5	27
12	1/2	SA102067/1212	3/4-16	12x1,5	37	17	9,5	19
12	1/2	SA102067/1214	3/4-16	14x1,5	37	17	9,5	19
12	1/2	SA102067/1220	3/4-16	20x1,5	42	17	12,5	27
12	1/2	SA102067/1222	3/4-16	22x1,5	42	17	13,5	27
12	1/2	SA102067/1226	3/4-16	26x1,5	44,5	17	14	36
14÷16	5/8	SA102067/1612	7/8-14	12x1,5	40,5	19,5	9,5	24
14÷16	5/8	SA102067/1616	7/8-14	16x1,5	42	19,5	11	24
14÷16	5/8	SA102067/1626	7/8-14	26x1,5	46	19,5	14	36
14÷16	5/8	SA102067/1627	7/8-14	27x2	49,5	19,5	16,5	32
18-20	3/4	SA102067/2018	1" 1/16-12	18x1,5	46	22	12,5	27
18-20	3/4	SA102067/2026	1" 1/16-12	26x1,5	49,5	22	14	36
18-20	3/4	SA102067/2030	1" 1/16-12	30x1,5	52	22	15	41
18-20	3/4	SA102067/2033	1" 1/16-12	33x2	54,5	22	16,5	41
25	1"	SA102067/2522	1" 5/16-12	22x1,5	49	23	13,5	36
25	1"	SA102067/2526	1" 5/16-12	26x1,5	50	23	14	36
25	1"	SA102067/2530	1" 5/16-12	30x1,5	53	23	15	41
25	1"	SA102067/2542	1" 5/16-12	42x2	57	23	17	50
30-32	1" 1/4	SA102067/3233	1" 5/8-12	33x2	57	24,5	16,5	42
38	1" 1/2	SA102067/3842	1" 7/8-12	42x2	63,5	27,5	17	50

102067

Terminale dritto
JIC cono 37° - Metrico cil.
con O.R. e rondella
per sedi ISO 9974
Connector male JIC - Metric
with O.R. and retaining ring
ISO 9974 ports
SEDI PAG.32 / PORTS PAG.32

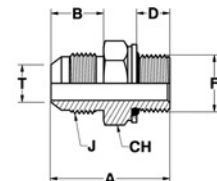

RACCORDI PER TUBI SVASATI - 37°

37° - FLARED TUBE CONNECTORS

102319

Terminale diritto
JIC cono 37° - Metrico cil.
con O.R. per sedi ISO 6149
Connector male JIC - male Metric
with O.R. ISO 6149 ports

SEDI PAG.30 / PORTS PAG.30

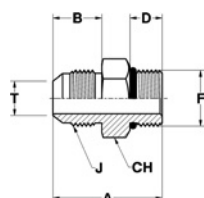

T		RIFERIMENTO REFERENCE	J	F	A	B	D	CH
MM.	IN.		UNF-UN	METRICO METRIC				
6	1/4	A102319/0610	7/16-20	10x1	30	14	9,5	14
6	1/4	A102319/0612	7/16-20	12x1,5	33	14	11	17
8	5/16	A102319/0810	1/2-20	10x1	30	14	9,5	14
8	5/16	A102319/0812	1/2-20	12x1,5	33	14	11	17
8	5/16	A102319/0814	1/2-20	14x1,5	34	14	11	19
10	3/8	A102319/1014	9/16-18	14x1,5	34	14	11	19
10	3/8	A102319/1016	9/16-18	16x1,5	35	14	12,5	22
12	1/2	A102319/1216	3/4-16	16x1,5	38	17	12,5	22
12	1/2	A102319/1218	3/4-16	18x1,5	39,5	17	14	24
14÷16	5/8	A102319/1618	7/8-14	18x1,5	42	19,5	14	24
14÷16	5/8	A102319/1622	7/8-14	22x1,5	44,5	19,5	15	27
18-20	3/4	A102319/2022	1" 1/16-12	22x1,5	48	22	15	30
18-20	3/4	A102319/2027	1" 1/16-12	27x2	52	22	18,5	32
22	7/8	A102319/2226	1" 3/16-12	26x1,5	49	23	16	36
25	1"	A102319/2527	1" 5/16-12	27x2	53	23	18,5	36
25	1"	A102319/2533	1" 5/16-12	33x2	54	23	18,5	41
30-32	1" 1/4	A102319/3242	1" 5/8-12	42x2	58	24,5	19	50
38	1" 1/2	A102319/3848	1" 7/8-12	48x2	65,5	27,5	21,5	55
6	1/4	SA102319/0614	7/16-20	14x1,5	34	14	11	19
6	1/4	SA102319/0618	7/16-20	18x1,5	36,5	14	14	24
6	1/4	SA102319/0622	7/16-20	22x1,5	39	14	15	27
8	5/16	SA102319/0818	1/2-20	18x1,5	37,5	14	14	24
10	3/8	SA102319/1010	9/16-18	10x1	32	14	9,5	17
10	3/8	SA102319/1012	9/16-18	12x1,5	34,5	14	11	17
10	3/8	SA102319/1018	9/16-18	18x1,5	37,5	14	14	24
10	3/8	SA102319/1022	9/16-18	22x1,5	38,5	14	15	27
12	1/2	SA102319/1214	3/4-16	14x1,5	37	17	11	19
12	1/2	SA102319/1220	3/4-16	20x1,5	42	17	14	27
12	1/2	SA102319/1222	3/4-16	22x1,5	42	17	15	27
14÷16	5/8	SA102319/1614	7/8-14	14x1,5	39	19,5	11	24
14÷16	5/8	SA102319/1616	7/8-14	16x1,5	42	19,5	12,5	24
14÷16	5/8	SA102319/1627	7/8-14	27x2	49,5	19,5	18,5	32
14÷16	5/8	SA102319/1633	7/8-14	33x2	50,5	19,5	18,5	41
18-20	3/4	SA102319/2018	1" 1/16-12	18x1,5	46	22	14	27
18-20	3/4	SA102319/2033	1" 1/16-12	33x2	54,5	22	18,5	41
22	7/8	SA102319/2222	1" 3/16-12	22x1,5	48	23	15	32
25	1"	SA102319/2522	1" 5/16-12	22x1,5	49	23	15	36
25	1"	SA102319/2542	1" 5/16-12	42x2	57	23	19	50
30-32	1" 1/4	SA102319/3233	1" 5/8-12	33x2	57	24,5	18,5	42
38	1" 1/2	SA102319/3833	1" 7/8-12	33x2	63	27,5	18,5	50



102078

T		RIFERIMENTO REFERENCE	J	F	A	B	D	CH
MM.	IN.		UNF-UN	METRICO METRIC				
6	1/4	A102078/0610	7/16-20	10x1	30	14	8	14
6	1/4	A102078/0612	7/16-20	12x1,5	35	14	12	17
8	5/16	A102078/0810	1/2-20	10x1	30	14	8	14
8	5/16	A102078/0812	1/2-20	12x1,5	35	14	12	17
10	3/8	A102078/1014	9/16-18	14x1,5	36	14	12	19
10	3/8	A102078/1016	9/16-18	16x1,5	36	14	12	22
12	1/2	A102078/1216	3/4-16	16x1,5	39	17	12	22
12	1/2	A102078/1218	3/4-16	18x1,5	39,5	17	12	24
14÷16	5/8	A102078/1618	7/8-14	18x1,5	42	19,5	12	24
14÷16	5/8	A102078/1620	7/8-14	20x1,5	45	19,5	14	27
14÷16	5/8	A102078/1622	7/8-14	22x1,5	45	19,5	14	27
18-20	3/4	A102078/2022	1" 1/16-12	22x1,5	48,5	22	14	30
18-20	3/4	A102078/2027	1" 1/16-12	27x2	52	22	16	32
25	1"	A102078/2526	1" 5/16-12	26x1,5	55	23	16	36
25	1"	A102078/2527	1" 5/16-12	27x2	53	23	16	36
25	1"	A102078/2533	1" 5/16-12	33x2	56	23	18	41
30-32	1" 1/4	A102078/3242	1" 5/8-12	42x2	61	24,5	20	50
38	1" 1/2	A102078/3848	1" 7/8-12	48x2	68	27,5	22	55
12	1/2	SA102078/1214	3/4-16	14x1,5	39	17	12	22

Terminale diritto
JIC cono 37° - Metrico cil.
con tenuta ad elastomero
per sedi ISO 9974
Connector male JIC - Metric
with elastomer seal
ISO 9974 ports

SEDI PAG.34 / PORTS PAG.34

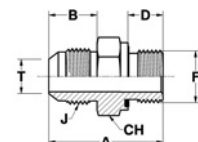

RACCORDI PER TUBI SVASATI - 37°

37° - FLARED TUBE CONNECTORS

102166

Terminale diritto femmina
 JIC cono 37° - maschio
 SAE UNF-UN per sedi ISO 11926
 Connector swivel female
 JIC - male SAE UNF-UN
 with O.R. ISO 11926 ports
 SEDI PAG.30 / PORTS PAG.30

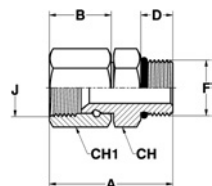

T		RIFERIMENTO REFERENCE	J	F	A	B	D	CH	CH ₁
MM.	IN.		UNF-UN	UNF-UN					
6	1/4	A102166/0611	7/16-20	7/16-20	35.5	18,5	9	14	14
6	1/4	A102166/0612	7/16-20	1/2-20	35.5	18,5	9	16	14
6	1/4	A102166/0614	7/16-20	9/16-18	37.5	18,5	10	19	14
8	5/16	A102166/0812	1/2-20	1/2-20	37.5	20,5	9	16	17
10	3/8	A102166/1014	9/16-18	9/16-18	40.5	21,5	10	19	17
10	3/8	A102166/1019	9/16-18	3/4-16	42	21,5	11	22	17
12	1/2	A102166/1219	3/4-16	3/4-16	43.5	23	11	22	22
12	1/2	A102166/1222	3/4-16	7/8-14	46.5	23	13	27	22
12	1/2	A102166/1227	3/4-16	1" 1/16-12	51	23	15	32	22
14÷16	5/8	A102166/1619	7/8-14	3/4-16	47	26	11	24	27
14÷16	5/8	A102166/1622	7/8-14	7/8-14	49.5	26	13	27	27
14÷16	5/8	A102166/1627	7/8-14	1" 1/16-12	54	26	15	32	27
18-20	3/4	A102166/2019	1" 1/16-12	3/4-16	49.5	27,5	11	27	32
18-20	3/4	A102166/2022	1" 1/16-12	7/8-14	51	27,5	13	27	32
18-20	3/4	A102166/2027	1" 1/16-12	1" 1/16-12	55.5	27,5	15	32	32
18-20	3/4	A102166/2033	1" 1/16-12	1" 5/16-12	56.5	27,5	15	38	32
22	7/8	A102166/2230	1" 3/16-12	1" 3/16-12	57	29	15	35	36
25	1"	A102166/2527	1" 5/16-12	1" 1/16-12	58	30	15	35	38
25	1"	A102166/2533	1" 5/16-12	1" 5/16-12	59	30	15	38	38
25	1"	A102166/2541	1" 5/16-12	1" 5/8-12	60.5	30	15	48	38
30-32	1" 1/4	A102166/3241	1" 5/8-12	1" 5/8-12	63	32,5	15	48	50
38	1" 1/2	A102166/3848	1" 7/8-12	1" 7/8-12	70.5	38	15	55	57
8	5/16	SA102166/0811	1/2-20	7/16-20	37.5	20,5	9	14	17
10	3/8	SA102166/1011	9/16-18	7/16-20	38.5	21,5	9	14	17
12	1/2	SA102166/1214	3/4-16	9/16-18	42.5	23	10	22	22
30-32	1" 1/4	SA102166/3233	1" 5/8-12	1" 5/16-12	63	32,5	15	41	50
30-32	1" 1/4	SA102166/3248	1" 5/8-12	1" 7/8-12	64	32,5	15	55	50
38	1" 1/2	SA102166/3841	1" 7/8-12	1" 5/8-12	74.5	38	15	50	57



T		RIFERIMENTO REFERENCE	J	F	A	B	D	CH	CH ₁
MM.	IN.		UNF-UN	GAS CIL.BSPP					
6	1/4	A102177/0610	7/16-20	1/8	33.5	18,5	7	14	14
6	1/4	A102177/0613	7/16-20	1/4	39	18,5	10	19	14
6	1/4	A102177/0617	7/16-20	3/8	40	18,5	10	24	14
6	1/4	A102177/0621	7/16-20	1/2	43	18,5	12	27	14
8	5/16	A102177/0810	1/2-20	1/8	36	20,5	7	14	17
8	5/16	A102177/0813	1/2-20	1/4	41	20,5	10	19	17
8	5/16	A102177/0817	1/2-20	3/8	42	20,5	10	24	17
10	3/8	A102177/1013	9/16-18	1/4	42	21,5	10	19	17
10	3/8	A102177/1017	9/16-18	3/8	43	21,5	10	24	17
10	3/8	A102177/1021	9/16-18	1/2	46	21,5	12	27	17
12	1/2	A102177/1213	3/4-16	1/4	44	23	10	22	22
12	1/2	A102177/1217	3/4-16	3/8	45	23	10	24	22
12	1/2	A102177/1221	3/4-16	1/2	47.5	23	12	27	22
12	1/2	A102177/1226	3/4-16	3/4	52	23	10	36	22
14÷16	5/8	A102177/1617	7/8-14	3/8	48	26	10	24	27
14÷16	5/8	A102177/1621	7/8-14	1/2	50.5	26	12	27	27
14÷16	5/8	A102177/1626	7/8-14	3/4	55	26	14	36	27
18-20	3/4	A102177/2021	1" 1/16-12	1/2	53.5	27,5	12	30	32
18-20	3/4	A102177/2026	1" 1/16-12	3/4	56.5	27,5	14	36	32
18-20	3/4	A102177/2033	1" 1/16-12	1"	59.5	27,5	15,5	41	32
22	7/8	A102177/2226	1" 3/16-12	3/4	58	29	14	36	36
25	1"	A102177/2526	1" 5/16-12	3/4	59	30	14	36	38
25	1"	A102177/2533	1" 5/16-12	1"	62	30	15,5	41	38
25	1"	A102177/2542	1" 5/16-12	1" 1/4	65	30	17,5	50	38
30-32	1" 1/4	A102177/3233	1" 5/8-12	1"	64.5	32,5	15,5	42	50
30-32	1" 1/4	A102177/3242	1" 5/8-12	1" 1/4	67.5	32,5	17,5	50	50
38	1" 1/2	A102177/3842	1" 7/8-12	1" 1/4	73	38	17,5	50	57
38	1" 1/2	A102177/3848	1" 7/8-12	1" 1/2	77	38	19,5	60	57
8	5/16	SA102177/0821	1/2-20	1/2	45	20,5	12	27	17
12	1/2	SA102177/1210	3/4-16	1/8	40	23	7	19	22
14÷16	5/8	SA102177/1613	7/8-14	1/4	47	26	10	22	27
18-20	3/4	SA102177/1623	1" 1/16-12	5/8	51	26	12	30	27
18-20	3/4	SA102177/2017	1" 1/16-12	3/8	50.5	27,5	10	27	32
18-20	3/4	SA102177/2023	1" 1/16-12	5/8	52.5	27,5	12	30	32
25	1"	SA102177/2521	1" 5/16-12	1/2	57	30	12	32	38
30-32	1" 1/4	SA102177/3221	1" 5/8-12	1/2	60	32,5	12	41	50
30-32	1" 1/4	SA102177/3226	1" 5/8-12	3/4	62.5	32,5	14	41	50
30-32	1" 1/4	SA102177/3248	1" 5/8-12	1" 1/2	71.5	32,5	19,5	60	50
38	1" 1/2	SA102177/3833	1" 7/8-12	1"	73	38	15,5	50	57

102177

Terminale diritto femmina
JIC cono 37° - maschio
GAS cil. (BSPP) con O.R. e rondella
per sedi ISO 1179
Connector swivel female
JIC - male BSPP
with O.R. and retaining ring
ISO 1179 ports
SEDI PAG.32 / PORTS PAG.32

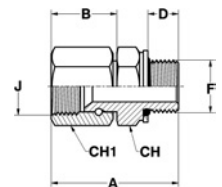

RACCORDI PER TUBI SVASATI - 37°

37° - FLARED TUBE CONNECTORS

102386

Terminale diritto femmina
JIC cono 37° - maschio
GAS cil. (JIS) con O.R.
per sedi JIS 2351
Connector swivel female
JIC - male JIS
with O.R. JIS 2351 ports
SEDI PAG.31 / PORTS PAG.31

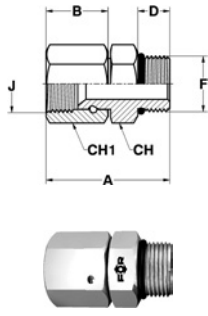

T		RIFERIMENTO REFERENCE	J	F	A	B	D	CH	CH ₁
MM.	IN.		UNF-UN	GAS CIL-JIS					
6	1/4	A102386/0610	7/16-20	1/8	35	18,5	9	14	14
6	1/4	A102386/0613	7/16-20	1/4	39,5	18,5	12	19	14
6	1/4	A102386/0617	7/16-20	3/8	40,5	18,5	12	22	14
8	5/16	A102386/0813	1/2-20	1/4	41,5	20,5	12	19	17
8	5/16	A102386/0817	1/2-20	3/8	42,5	20,5	12	22	17
10	3/8	A102386/1013	9/16-18	1/4	42,5	21,5	12	19	17
10	3/8	A102386/1017	9/16-18	3/8	43,5	21,5	12	22	17
10	3/8	A102386/1021	9/16-18	1/2	48	21,5	16	27	17
12	1/2	A102386/1213	3/4-16	1/4	44	23	12	22	22
12	1/2	A102386/1217	3/4-16	3/8	45	23	12	22	22
12	1/2	A102386/1221	3/4-16	1/2	49,5	23	16	27	22
14÷16	5/8	A102386/1617	7/8-14	3/8	48	26	12	24	27
14÷16	5/8	A102386/1621	7/8-14	1/2	52,5	26	16	27	27
14÷16	5/8	A102386/1626	7/8-14	3/4	56	26	17	36	27
18-20	3/4	A102386/2021	1" 1/16-12	1/2	55,5	27,5	16	30	32
18-20	3/4	A102386/2026	1" 1/16-12	3/4	57,5	27,5	17	36	32
18-20	3/4	A102386/2033	1" 1/16-12	1"	61,5	27,5	20	41	32
25	1"	A102386/2526	1" 5/16-12	3/4	60	30	17	36	38
25	1"	A102386/2533	1" 5/16-12	1"	64	30	20	41	38
25	1"	A102386/2542	1" 5/16-12	1" 1/4	65	30	20	50	38
30-32	1" 1/4	A102386/3233	1" 5/8-12	1"	66,5	32,5	20	42	50
30-32	1" 1/4	A102386/3242	1" 5/8-12	1" 1/4	67,5	32,5	20	50	50
38	1" 1/2	A102386/3842	1" 7/8-12	1" 1/4	73	38	20	50	57
38	1" 1/2	A102386/3848	1" 7/8-12	1" 1/2	75	38	20	55	57

102188

Terminale diritto femmina
JIC cono 37° - maschio
GAS cil. (BSPP) con tenuta
ad elastomero per sedi ISO 1179
Connector swivel female
JIC - male BSPP
with elastomer seal ISO 1179 ports
SEDI PAG.34 / PORTS PAG.34

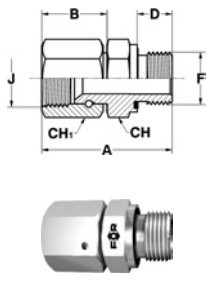

T		RIFERIMENTO REFERENCE	J	F	A	B	D	CH	CH ₁
MM.	IN.		UNF-UN	GAS CIL.BSPP					
6	1/4	A102188/0610	7/16-20	1/8	34,5	18,5	8	14	14
6	1/4	A102188/0613	7/16-20	1/4	41	18,5	12	19	14
8	5/16	A102188/0813	1/2-20	1/4	43	20,5	12	19	17
8	5/16	A102188/0817	1/2-20	3/8	43	20,5	12	22	17
10	3/8	A102188/1013	9/16-18	1/4	44	21,5	12	19	17
10	3/8	A102188/1017	9/16-18	3/8	44	21,5	12	22	17
12	1/2	A102188/1217	3/4-16	3/8	45,5	23	12	22	22
12	1/2	A102188/1221	3/4-16	1/2	49	23	14	27	22
14÷16	5/8	A102188/1617	7/8-14	3/8	49	26	12	24	27
14÷16	5/8	A102188/1621	7/8-14	1/2	52	26	14	27	27
14÷16	5/8	A102188/1626	7/8-14	3/4	56	26	16	32	27
18-20	3/4	A102188/2026	1" 1/16-12	3/4	57,5	27,5	16	32	32
18-20	3/4	A102188/2033	1" 1/16-12	1"	60,5	27,5	18	41	32
25	1"	A102188/2526	1" 5/16-12	3/4	60	30	16	32	38
25	1"	A102188/2533	1" 5/16-12	1"	63	30	18	41	38
25	1"	A102188/2542	1" 5/16-12	1" 1/4	66,5	30	20	50	38
30-32	1" 1/4	A102188/3233	1" 5/8-12	1"	66,5	32,5	18	41	50
30-32	1" 1/4	A102188/3242	1" 5/8-12	1" 1/4	69	32,5	20	50	50
38	1" 1/2	A102188/3848	1" 7/8-12	1" 1/2	78,5	38	22	60	57
18-20	3/4	SA102188/2021	1" 1/16-12	1/2	54,5	27,5	14	27	32

FOR S.P.A. - NORME E DIMENSIONI SOGGETTE A MODIFICHE SENZA PREAVVISO.
FOR S.P.A. - DESIGN DETAILS AND SPECIFICATIONS SUBJECT TO CHANGE WITHOUT PRIOR NOTICE.



T		RIFERIMENTO REFERENCE	J	F	A	B	D	CH	CH ₁
MM.	IN.								
6	1/4	A102209/0610	UNF-UN 7/16-20	METRICO METRIC 10x1	35,5	18,5	8,5	14	14
6	1/4	A102209/0612	7/16-20	12x1,5	37,5	18,5	9,5	17	14
8	5/16	A102209/0810	1/2-20	10x1	37,5	20,5	8,5	14	17
8	5/16	A102209/0812	1/2-20	12x1,5	40	20,5	9,5	17	17
8	5/16	A102209/0814	1/2-20	14x1,5	40	20,5	9,5	19	17
10	3/8	A102209/1014	9/16-18	14x1,5	41	21,5	9,5	19	17
10	3/8	A102209/1016	9/16-18	16x1,5	42,5	21,5	11	22	17
12	1/2	A102209/1216	3/4-16	16x1,5	44	23	11	22	22
12	1/2	A102209/1218	3/4-16	18x1,5	46	23	12,5	24	22
14÷16	5/8	A102209/1618	7/8-14	18x1,5	49	26	12,5	24	27
14÷16	5/8	A102209/1620	7/8-14	20x1,5	49,5	26	12,5	27	27
14÷16	5/8	A102209/1622	7/8-14	22x1,5	52	26	13,5	27	27
18-20	3/4	A102209/2022	1" 1/16-12	22x1,5	53,5	27,5	13,5	27	32
18-20	3/4	A102209/2027	1" 1/16-12	27x2	57,5	27,5	16,5	32	32
22	7/8	A102209/2226	1" 3/16-12	26x1,5	57	29	14	36	36
25	1"	A102209/2527	1" 5/16-12	27x2	60	30	16,5	32	38
25	1"	A102209/2533	1" 5/16-12	33x2	62	30	16,5	41	38
30-32	1" 1/4	A102209/3242	1" 5/8-12	42x2	66	32,5	17	50	50
38	1" 1/2	A102209/3848	1" 7/8-12	48x2	76	38	19,5	55	57
8	5/16	SA102209/0818	1/2-20	18x1,5	44,5	20,5	12,5	24	17
10	3/8	SA102209/1018	9/16-18	18x1,5	45,5	21,5	12,5	24	17
18-20	3/4	SA102209/2020	1" 1/16-12	20x1,5	52,5	27,5	12,5	27	32

102209

Terminale diritto femmina
JIC cono 37° - maschio
Metrico cil. con O.R. e rondella
per sedi ISO 9974
Connector swivel female
JIC - male Metric
with O.R. and retaining ring
ISO 9974 ports
SEDI PAG.32 / PORTS PAG.32

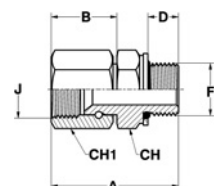

T		RIFERIMENTO REFERENCE	J	F	A	B	D	CH	CH ₁
MM.	IN.								
6	1/4	A102331/0610	UNF-UN 7/16-20	METRICO METRIC 10x1	35,5	18,5	9,5	14	14
6	1/4	A102331/0612	7/16-20	12x1,5	37,5	18,5	11	17	14
8	5/16	A102331/0810	1/2-20	10x1	37,5	20,5	9,5	14	17
8	5/16	A102331/0812	1/2-20	12x1,5	40	20,5	11	17	17
8	5/16	A102331/0814	1/2-20	14x1,5	40	20,5	11	19	17
10	3/8	A102331/1014	9/16-18	14x1,5	41	21,5	11	19	17
10	3/8	A102331/1016	9/16-18	16x1,5	42,5	21,5	12,5	22	17
12	1/2	A102331/1216	3/4-16	16x1,5	44	23	12,5	22	22
12	1/2	A102331/1218	3/4-16	18x1,5	46	23	14	24	22
14÷16	5/8	A102331/1618	7/8-14	18x1,5	49	26	14	24	27
14÷16	5/8	A102331/1622	7/8-14	22x1,5	52	26	15	27	27
18-20	3/4	A102331/2022	1" 1/16-12	22x1,5	53,5	27,5	15	27	32
18-20	3/4	A102331/2027	1" 1/16-12	27x2	57,5	27,5	18,5	32	32
25	1"	A102331/2527	1" 5/16-12	27x2	60	30	18,5	32	38
25	1"	A102331/2533	1" 5/16-12	33x2	62	30	18,5	41	38
30-32	1" 1/4	A102331/3242	1" 5/8-12	42x2	66	32,5	19	50	50
38	1" 1/2	A102331/3848	1" 7/8-12	48x2	76	38	21,5	55	57
10	3/8	SA102331/1018	9/16-18	18x1,5	45,5	21,5	14	24	17
18-20	3/4	SA102331/2020	1" 1/16-12	20x1,5	52,5	27,5	15	27	32

102331

Terminale diritto femmina
JIC cono 37° - maschio
Metrico cil. con O.R.
per sedi ISO 6149
Connector swivel female
JIC - male Metric
with O.R. ISO 6149 ports
SEDI PAG.30 / PORTS PAG.30

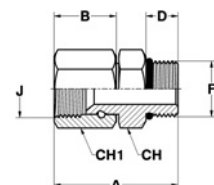

RACCORDI PER TUBI SVASATI - 37°

37° - FLARED TUBE CONNECTORS

102210

Terminale diritto femmina
 JIC cono 37° - maschio
 Metrico cil. con tenuta
 ad elastomero per sedi ISO 9974
 Connector swivel female
 JIC - male Metric
 with elastomer seal
 ISO 9974 ports

SEDI PAG.34 / PORTS PAG.34

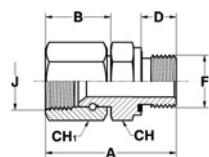

T		RIFERIMENTO REFERENCE	J	F	A	B	D	CH	CH ₁
MM.	IN.		UNF-UN	METRICO METRIC					
6	1/4	A102210/0610	7/16-20	10x1	34,5	18,5	8	14	14
6	1/4	A102210/0612	7/16-20	12x1,5	39,5	18,5	12	17	14
8	5/16	A102210/0810	1/2-20	10x1	36,5	20,5	8	14	17
8	5/16	A102210/0812	1/2-20	12x1,5	41,5	20,5	12	17	17
10	3/8	A102210/1014	9/16-18	14x1,5	43,5	21,5	12	19	17
10	3/8	A102210/1016	9/16-18	16x1,5	43,5	21,5	12	22	17
12	1/2	A102210/1216	3/4-16	16x1,5	45	23	12	22	22
12	1/2	A102210/1218	3/4-16	18x1,5	45,5	23	12	24	22
14÷16	5/8	A102210/1618	7/8-14	18x1,5	48,5	26	12	24	27
14÷16	5/8	A102210/1622	7/8-14	22x1,5	51,5	26	14	27	27
18-20	3/4	A102210/2022	1" 1/16-12	22x1,5	54	27,5	14	27	32
18-20	3/4	A102210/2027	1" 1/16-12	27x2	57,5	27,5	16	32	32
25	1"	A102210/2527	1" 5/16-12	27x2	60	30	16	36	38
25	1"	A102210/2533	1" 5/16-12	33x2	63	30	18	41	38
30-32	1" 1/4	A102210/3242	1" 5/8-12	42x2	69,5	32,5	20	50	50
38	1" 1/2	A102210/3848	1" 7/8-12	48x2	78,5	38	22	55	57



102100

T		RIFERIMENTO REFERENCE	J	F	A	B	D	CH
MM.	IN.		UNF-UN	NPTF				
6	1/4	A102100/0610	7/16-20	1/8	31	14	10	13
6	1/4	A102100/0613	7/16-20	1/4	35.5	14	14,5	14
8	5/16	A102100/0810	1/2-20	1/8	31	14	10	14
8	5/16	A102100/0813	1/2-20	1/4	35.5	14	14,5	14
10	3/8	A102100/1010	9/16-18	1/8	31.5	14	10	16
10	3/8	A102100/1013	9/16-18	1/4	36	14	14,5	16
10	3/8	A102100/1017	9/16-18	3/8	36	14	14,5	19
10	3/8	A102100/1021	9/16-18	1/2	42.5	14	19	22
12	1/2	A102100/1213	3/4-16	1/4	39	17	14,5	21
12	1/2	A102100/1217	3/4-16	3/8	39	17	14,5	21
12	1/2	A102100/1221	3/4-16	1/2	45.5	17	19	22
12	1/2	A102100/1226	3/4-16	3/4	47.5	17	19	27
14÷16	5/8	A102100/1617	7/8-14	3/8	43.5	19,5	14,5	24
14÷16	5/8	A102100/1621	7/8-14	1/2	48	19,5	19	24
14÷16	5/8	A102100/1626	7/8-14	3/4	50	19,5	19	27
18-20	3/4	A102100/2021	1" 1/16-12	1/2	52.5	22	19	27
18-20	3/4	A102100/2026	1" 1/16-12	3/4	52.5	22	19	30
18-20	3/4	A102100/2033	1" 1/16-12	1"	57.5	22	24	35
22	7/8	A102100/2226	1" 3/16-12	3/4	53	22,5	19	32
25	1"	A102100/2526	1" 5/16-12	3/4	53.5	23	19	35
25	1"	A102100/2533	1" 5/16-12	1"	58.5	23	24	35
30-32	1" 1/4	A102100/3233	1" 5/8-12	1"	61.5	24,5	24	42
30-32	1" 1/4	A102100/3242	1" 5/8-12	1" 1/4	62	24,5	24,5	46
38	1" 1/2	A102100/3842	1" 7/8-12	1" 1/4	67	27,5	24,5	50
38	1" 1/2	A102100/3848	1" 7/8-12	1" 1/2	68	27,5	25,5	50
3	1/8	SA102100/0310	5/16-24	1/8	28	11,5	10	13
6	1/4	SA102100/0617	7/16-20	3/8	36	14	14,5	19
6	1/4	SA102100/0621	7/16-20	1/2	42.5	14	19	22
8	5/16	SA102100/0817	1/2-20	3/8	36	14	14,5	19
8	5/16	SA102100/0821	1/2-20	1/2	42.5	14	19	22
10	3/8	SA102100/1026	9/16-18	3/4	44.5	14	19	30
12	1/2	SA102100/1210	3/4-16	1/8	36	17	10	21
12	1/2	SA102100/1233	3/4-16	1"	52	17	24	35
12	1/2	SA102100/1242	3/4-16	1" 1/4	54.5	17	24,5	46
12	1/2	SA102100/1248	3/4-16	1" 1/2	57.5	17	25,5	50
14÷16	5/8	SA102100/1613	7/8-14	1/4	43.5	19,5	14,5	24
18-20	3/4	SA102100/2017	1" 1/16-12	3/8	45	22	14,5	27
18-20	3/4	SA102100/2042	1" 1/16-12	1" 1/4	59.5	22	24,5	46
18-20	3/4	SA102100/2048	1" 1/16-12	1" 1/2	62.5	22	25,5	50
25	1"	SA102100/2521	1" 5/16-12	1/2	53.5	23	19	36
25	1"	SA102100/2542	1" 5/16-12	1" 1/4	60.5	23	24,5	42
25	1"	SA102100/2560	1" 5/16-12	2"	66	23	26	65
30-32	1" 1/4	SA102100/3248	1" 5/8-12	1" 1/2	65	24,5	25,5	50
30-32	1" 1/4	SA102100/3260	1" 5/8-12	2"	69	24,5	26	65
50	2"	SA102100/5048	2" 1/2-12	1" 1/2	78.5	34	25,5	65
50	2"	SA102100/5060	2" 1/2-12	2"	79	34	26	65

Terminale dritto
JIC cono 37° - NPTF
per sedi SAE 476
Connector male
JIC - NPTF taper SAE 476 ports
SEDI PAG.35 / PORTS PAG.35

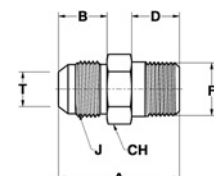

RACCORDI PER TUBI SVASATI - 37°

37° - FLARED TUBE CONNECTORS

102111

Terminale diritto
JIC cono 37° - GAS conico (BSPT)
per sedi ISO 7
Connector male
JIC - BSPT taper ISO 7 ports

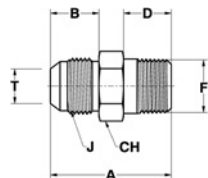

T		RIFERIMENTO REFERENCE	J	F	A	B	D	CH
MM.	IN.		UNF-UN	GAS CON.BSPT				
6	1/4	A102111/0610	7/16-20	1/8	29	14	9	13
6	1/4	A102111/0613	7/16-20	1/4	33	14	13	14
8	5/16	A102111/0810	1/2-20	1/8	29	14	9	14
8	5/16	A102111/0813	1/2-20	1/4	33	14	13	14
10	3/8	A102111/1013	9/16-18	1/4	33.5	14	13	17
10	3/8	A102111/1017	9/16-18	3/8	33.5	14	13,5	19
10	3/8	A102111/1021	9/16-18	1/2	37.5	14	15,5	24
12	1/2	A102111/1213	3/4-16	1/4	36.5	17	13	22
12	1/2	A102111/1217	3/4-16	3/8	36.5	17	13,5	22
12	1/2	A102111/1221	3/4-16	1/2	40.5	17	15,5	24
14÷16	5/8	A102111/1617	7/8-14	3/8	41	19,5	13,5	24
14÷16	5/8	A102111/1621	7/8-14	1/2	43	19,5	15,5	24
14÷16	5/8	A102111/1626	7/8-14	3/4	47	19,5	17	30
18-20	3/4	A102111/2021	1" 1/16-12	1/2	47.5	22	15,5	30
18-20	3/4	A102111/2026	1" 1/16-12	3/4	49.5	22	17	30
18-20	3/4	A102111/2033	1" 1/16-12	1"	51.5	22	19,5	36
22	7/8	A102111/2226	1" 3/16-12	3/4	50	22,5	17	32
25	1"	A102111/2526	1" 5/16-12	3/4	50.5	23	17	36
25	1"	A102111/2533	1" 5/16-12	1"	52.5	23	19,5	36
30-32	1" 1/4	A102111/3233	1" 5/8-12	1"	55.5	24,5	19,5	46
30-32	1" 1/4	A102111/3242	1" 5/8-12	1" 1/4	57.5	24,5	21,5	46
38	1" 1/2	A102111/3848	1" 7/8-12	1" 1/2	62.5	27,5	21,5	50
6	1/4	SA102111/0617	7/16-20	3/8	33.5	14	13,5	19
8	5/16	SA102111/0817	1/2-20	3/8	35	14	13,5	19
10	3/8	SA102111/1010	9/16-18	1/8	30	14	9	17
10	3/8	SA102111/1026	9/16-18	3/4	40	14	17	30
12	1/2	SA102111/1226	3/4-16	3/4	43	17	17	30
14÷16	5/8	SA102111/1613	7/8-14	1/4	42	19,5	13	24
14÷16	5/8	SA102111/1633	7/8-14	1"	49	19,5	19,5	36
18-20	3/4	SA102111/2013	1" 1/16-12	1/4	45.5	22,5	13	30
25	1"	SA102111/2542	1" 5/16-12	1" 1/4	57.5	23	21,5	46
25	1"	SA102111/2560	1" 5/16-12	2"	65	23	26	65
30-32	1" 1/4	SA102111/3248	1" 5/8-12	1" 1/2	59.5	24,5	21,5	50
38	1" 1/2	SA102111/3842	1" 7/8-12	1" 1/4	62.5	27,5	21,5	50
50	2"	SA102111/5048	2" 1/2-12	1" 1/2	74.5	34	21,5	65
50	2"	SA102111/5060	2" 1/2-12	2"	76	34	26	65



102232

T		RIFERIMENTO REFERENCE	J	F	A	B	D	CH	CH ₁
MM.	IN.		UNF-UN	NPTF					
6	1/4	A102232/0610	7/16-20	1/8	35,5	18,5	10	13	14
6	1/4	A102232/0613	7/16-20	1/4	40	18,5	14,5	14	14
8	5/16	A102232/0810	1/2-20	1/8	37,5	20,5	10	14	17
8	5/16	A102232/0813	1/2-20	1/4	42	20,5	14,5	14	17
10	3/8	A102232/1010	9/16-18	1/8	39	21,5	10	16	17
10	3/8	A102232/1013	9/16-18	1/4	43,5	21,5	14,5	16	17
10	3/8	A102232/1017	9/16-18	3/8	43,5	21,5	14,5	19	17
10	3/8	A102232/1021	9/16-18	1/2	50	21,5	19	22	17
12	1/2	A102232/1213	3/4-16	1/4	45	23	14,5	21	22
12	1/2	A102232/1217	3/4-16	3/8	45	23	14,5	21	22
12	1/2	A102232/1221	3/4-16	1/2	51,5	23	19	22	22
12	1/2	A102232/1226	3/4-16	3/4	53,5	23	19	27	22
14÷16	5/8	A102232/1617	7/8-14	3/8	50	26	14,5	22	27
14÷16	5/8	A102232/1621	7/8-14	1/2	54,5	26	19	22	27
14÷16	5/8	A102232/1626	7/8-14	3/4	56,5	26	19	27	27
18-20	3/4	A102232/2021	1" 1/16-12	1/2	58	27,5	19	27	32
18-20	3/4	A102232/2026	1" 1/16-12	3/4	58	27,5	19	27	32
22	7/8	A102232/2226	1" 3/16-12	3/4	59,5	29	19	30	36
25	1"	A102232/2526	1" 5/16-12	3/4	60,5	30	19	35	38
25	1"	A102232/2533	1" 5/16-12	1"	65,5	30	24	35	38
30-32	1" 1/4	A102232/3233	1" 5/8-12	1"	69,5	32,5	24	41	50
30-32	1" 1/4	A102232/3242	1" 5/8-12	1" 1/4	70	32,5	24,5	46	50
38	1" 1/2	A102232/3848	1" 7/8-12	1" 1/2	78,5	38	25,5	50	57
18-20	3/4	SA102232/2033	1" 1/16-12	1"	64,5	27,5	24	35	32

Terminale diritto femmina
JIC cono 37° - maschio
NPTF per sedi SAE 476
Connector swivel female
JIC - male NPTF taper
SAE 476 ports

SEDI PAG.35 / PORTS PAG.35

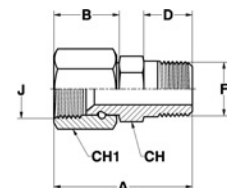

RACCORDI PER TUBI SVASATI - 37°

37° - FLARED TUBE CONNECTORS

102243

Terminale diritto femmina
JIC cono 37° - maschio
GAS conico (BSPT)
per sedi ISO 7
Connector swivel female
JIC - male BSPT taper
ISO 7 ports

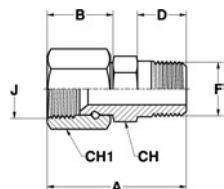

T		RIFERIMENTO REFERENCE	J	F	A	B	D	CH	CH ₁
MM.	IN.		UNF-UN	GAS CON.BSPT					
6	1/4	A102243/0610	7/16-20	1/8	34,5	18,5	9	14	14
6	1/4	A102243/0613	7/16-20	1/4	38,5	18,5	13	14	14
8	5/16	A102243/0810	1/2-20	1/8	36,5	20,5	9	14	17
8	5/16	A102243/0813	1/2-20	1/4	40,5	20,5	13	14	17
10	3/8	A102243/1013	9/16-18	1/4	41	21,5	13	17	17
10	3/8	A102243/1017	9/16-18	3/8	41,5	21,5	13,5	19	17
10	3/8	A102243/1021	9/16-18	1/2	45	21,5	15,5	24	17
12	1/2	A102243/1213	3/4-16	1/4	42	23	13	19	22
12	1/2	A102243/1217	3/4-16	3/8	43	23	13,5	19	22
12	1/2	A102243/1221	3/4-16	1/2	46,5	23	15,5	24	22
14÷16	5/8	A102243/1617	7/8-14	3/8	47,5	26	13,5	22	27
14÷16	5/8	A102243/1621	7/8-14	1/2	49,5	26	15,5	24	27
14÷16	5/8	A102243/1626	7/8-14	3/4	53,5	26	17	30	27
18-20	3/4	A102243/2021	1" 1/16-12	1/2	53	27,5	15,5	27	32
18-20	3/4	A102243/2026	1" 1/16-12	3/4	55	27,5	17	30	32
18-20	3/4	A102243/2033	1" 1/16-12	1"	57	27,5	19,5	36	32
22	7/8	A102243/2226	1" 3/16-12	3/4	56,5	29	17	30	36
25	1"	A102243/2526	1" 5/16-12	3/4	57,5	30	17	32	38
25	1"	A102243/2533	1" 5/16-12	1"	59,5	30	19,5	36	38
30-32	1" 1/4	A102243/3233	1" 5/8-12	1"	63,5	32,5	19,5	41	50
30-32	1" 1/4	A102243/3242	1" 5/8-12	1" 1/4	65,5	32,5	21,5	46	50
38	1" 1/2	A102243/3848	1" 7/8-12	1" 1/2	73	38	21,5	50	57
50	2"	SA102243/5060	2" 1/2-12	2"	79	47	26	65	75

102133

Giunzione diretta maschio
JIC cono 37° - femmina NPTF
Adapter male JIC - female
NPTF taper

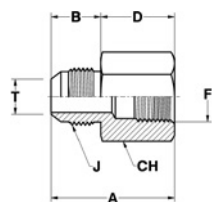

T		RIFERIMENTO REFERENCE	J	F	A	B	D	CH
MM.	IN.		UNF-UN	NPTF				
6	1/4	A102133/0610	7/16-20	1/8	30	14	16	14
6	1/4	A102133/0613	7/16-20	1/4	35,5	14	21,5	19
8	5/16	A102133/0810	1/2-20	1/8	30	14	16	14
8	5/16	A102133/0813	1/2-20	1/4	35,5	14	21,5	19
10	3/8	A102133/1013	9/16-18	1/4	35,5	14	21,5	19
10	3/8	A102133/1017	9/16-18	3/8	36,5	14	22,5	22
12	1/2	A102133/1213	3/4-16	1/4	38,5	17	21,5	22
12	1/2	A102133/1217	3/4-16	3/8	39,5	17	22,5	22
12	1/2	A102133/1221	3/4-16	1/2	45,5	17	28,5	30
14÷16	5/8	A102133/1621	7/8-14	1/2	48	19,5	28,5	30
18-20	3/4	A102133/2021	1" 1/16-12	1/2	50,5	22	28,5	30
18-20	3/4	A102133/2026	1" 1/16-12	3/4	52,5	22	30,5	35
22	7/8	A102133/2226	1" 3/16-12	3/4	53	22,5	30,5	35
25	1"	A102133/2533	1" 5/16-12	1"	59,5	23	36,5	41
30-32	1" 1/4	A102133/3242	1" 5/8-12	1" 1/4	63	24,5	38,5	50
38	1" 1/2	A102133/3848	1" 7/8-12	1" 1/2	66,5	27,5	39	60
6	1/4	SA102133/0621	7/16-20	1/2	43	14	29	27
10	3/8	SA102133/1021	9/16-18	1/2	42,5	14	28,5	30
18-20	3/4	SA102133/2033	1" 1/16-12	1"	58,5	22	36,5	41



T		RIFERIMENTO REFERENCE	J	F	A	B	D	CH
MM.	IN.		UNF-UN	GAS CIL.BSPP				
6	1/4	A102144/0610	7/16-20	1/8	30	14	16	14
6	1/4	A102144/0613	7/16-20	1/4	35.5	14	21,5	19
8	5/16	A102144/0810	1/2-20	1/8	30	14	16	14
8	5/16	A102144/0813	1/2-20	1/4	35.5	14	21,5	19
10	3/8	A102144/1013	9/16-18	1/4	35.5	14	21,5	19
10	3/8	A102144/1017	9/16-18	3/8	36.5	14	22,5	22
10	3/8	A102144/1021	9/16-18	1/2	42.5	14	28,5	27
12	1/2	A102144/1213	3/4-16	1/4	38.5	17	21,5	22
12	1/2	A102144/1217	3/4-16	3/8	39.5	17	22,5	22
12	1/2	A102144/1221	3/4-16	1/2	45.5	17	28,5	27
14÷16	5/8	A102144/1621	7/8-14	1/2	48	19,5	28,5	27
18-20	3/4	A102144/2021	1" 1/16-12	1/2	50.5	22	28,5	30
18-20	3/4	A102144/2026	1" 1/16-12	3/4	52.5	22	30,5	36
22	7/8	A102144/2226	1" 3/16-12	3/4	53	22,5	30,5	36
25	1"	A102144/2533	1" 5/16-12	1"	59.5	23	36,5	41
30-32	1" 1/4	A102144/3233	1" 5/8-12	1"	61	24,5	36,5	46
30-32	1" 1/4	A102144/3242	1" 5/8-12	1" 1/4	63	24,5	38,5	50
38	1" 1/2	A102144/3842	1" 7/8-12	1" 1/4	66	27,5	38,5	50
38	1" 1/2	A102144/3848	1" 7/8-12	1" 1/2	66.5	27,5	39	60
6	1/4	SA102144/0626	7/16-20	3/4	44	14	30	36
8	5/16	SA102144/0817	1/2-20	3/8	36.5	14	22,5	22
10	3/8	SA102144/1010	9/16-18	1/8	30	14	16	17
12	1/2	SA102144/1226	3/4-16	3/4	47.5	17	30,5	36
14÷16	5/8	SA102144/1617	7/8-14	3/8	42	19,5	22,5	24
18-20	3/4	SA102144/2017	1" 1/16-12	3/8	44	22	22	30
25	1"	SA102144/2526	1" 5/16-12	3/4	53.5	23	30,5	36

102144

Giunzione diretta maschio
JIC cono 37° - femmina
GAS cil. (BSPP)
Adapter male JIC - female BSPP

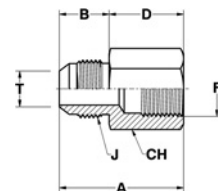

RIFERIMENTO REFERENCE	F	F ₁	A	B	CH	CH ₁
A102407/0606	7/16-20	7/16-20	48	26	36	14
A102407/0808	1/2-20	1/2-20	49	26	36	17
A102407/1010	9/16-18	9/16-18	50	26	36	17
A102407/1212	3/4-16	3/4-16	52	28	36	22
A102407/1616	7/8-14	7/8-14	54	30	36	27
A102407/2020	1" 1/16-12	1" 1/16-12	56	33	41	32
A102407/2525	1" 5/16-12	1" 5/16-12	60	34	46	38
A102407/3232	1" 5/8-12	1" 5/8-12	64	36	50	50
A102407/3838	1" 7/8-12	1" 7/8-12	70	39	60	57

102407

Giunzione diretta maschio
JIC cono 37° - femmina JIC
cono 37°
e attacco femmina BSPP
per presa di pressione
Straight union fitting
male/female JIC 37° cone
+ BSP port for
pressure test point

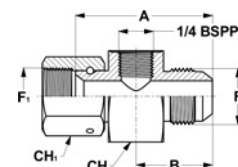

RACCORDI PER TUBI SVASATI - 37°

37° - FLARED TUBE CONNECTORS

102265

Giunzione diretta femmina
JIC cono 37° - maschio
JIC cono 37°
Reducer male - female JIC

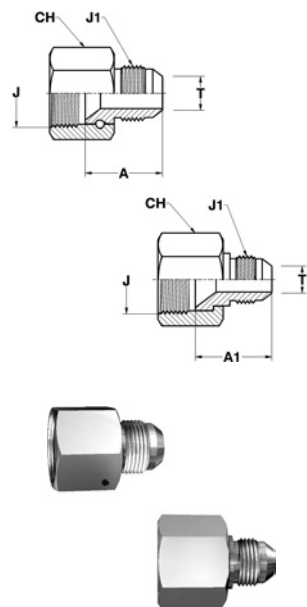

T		RIFERIMENTO REFERENCE	J	J ₁	A	A ₁	CH
MM.	IN.		UNF-UN	UNF-UN			
10	3/8	A102265/1006	9/16-18	7/16-20	-	24,5	17
10	3/8	A102265/1008	9/16-18	1/2-20	24,5	-	17
12	1/2	A102265/1206	3/4-16	7/16-20	-	25,5	22
12	1/2	A102265/1208	3/4-16	1/2-20	-	25,5	22
12	1/2	A102265/1210	3/4-16	9/16-18	-	25,5	22
14÷16	5/8	A102265/1606	7/8-14	7/16-20	-	26	27
14÷16	5/8	A102265/1610	7/8-14	9/16-18	-	26	27
14÷16	5/8	A102265/1612	7/8-14	3/4-16	29	-	27
18-20	3/4	A102265/2006	1"1/16-12	7/16-20	-	27,5	32
18-20	3/4	A102265/2010	1"1/16-12	9/16-18	-	27,5	32
18-20	3/4	A102265/2012	1"1/16-12	3/4-16	-	30,5	32
18-20	3/4	A102265/2016	1"1/16-12	7/8-14	31	-	32
22	7/8	A102265/2220	1"3/16-12	1"1/16-12	34	-	36
25	1"	A102265/2520	1"5/16-12	1"1/16-12	-	37,5	38
25	1"	A102265/2522	1"5/16-12	1"3/16-12	35,5	-	38
30-32	1"1/4	A102265/3220	1"5/8-12	1"1/16-12	-	39	50
30-32	1"1/4	A102265/3222	1"5/8-12	1"3/16-12	-	39,5	50
30-32	1"1/4	A102265/3225	1"5/8-12	1"5/16-12	-	40	50
38	1"1/2	A102265/3832	1"7/8-12	1"5/8-12	-	43	57
6	1/4	SA102265/0606	7/16-20	7/16-20	31	-	14
6	1/4	SA102265/0610	7/16-20	9/16-18	24	-	14
8	5/16	SA102265/0806	1/2-20	7/16-20	24	-	17
8	5/16	SA102265/0810	1/2-20	9/16-18	32	-	17
8	5/16	SA102265/0812	1/2-20	3/4-16	37	-	17
10	3/8	SA102265/1010	9/16-18	9/16-18	34	-	17
10	3/8	SA102265/1012	9/16-18	3/4-16	38	-	17
12	1/2	SA102265/1212	3/4-16	3/4-16	38	-	22
12	1/2	SA102265/1216	3/4-16	7/8-14	40	-	22
12	1/2	SA102265/1220	3/4-16	1"1/16-12	43,5	-	22
14÷16	5/8	SA102265/1608	7/8-14	1/2-20	-	26	27
14÷16	5/8	SA102265/1616	7/8-14	7/8-14	31	-	27
14÷16	5/8	SA102265/1625	7/8-14	1"5/16-12	47	-	27
18-20	3/4	SA102265/2008	1"1/16-12	1/2-20	-	29	32
18-20	3/4	SA102265/2020	1"1/16-12	1"1/16-12	45	-	32
18-20	3/4	SA102265/2025	1"1/16-12	1"5/16-12	36	-	32
25	1"	SA102265/2506	1"5/16-12	7/16-20	-	32,5	38
25	1"	SA102265/2508	1"5/16-12	1/2-20	-	29,5	38
25	1"	SA102265/2510	1"5/16-12	9/16-18	-	29,5	38
25	1"	SA102265/2512	1"5/16-12	3/4-16	-	31	38
25	1"	SA102265/2516	1"5/16-12	7/8-14	-	34	38
25	1"	SA102265/2525	1"5/16-12	1"5/16-12	49	-	38
30-32	1"1/4	SA102265/3216	1"5/8-12	7/8-14	-	36,5	50
30-32	1"1/4	SA102265/3238	1"5/8-12	1"7/8-12	56	-	50
38	1"1/2	SA102265/3812	1"7/8-12	3/4-16	-	35,5	57
38	1"1/2	SA102265/3816	1"7/8-12	7/8-14	-	38	57
38	1"1/2	SA102265/3820	1"7/8-12	1"1/16-12	-	41	57
38	1"1/2	SA102265/3822	1"7/8-12	1"3/16-12	-	39,5	57
38	1"1/2	SA102265/3825	1"7/8-12	1"5/16-12	-	42	57
38	1"1/2	SA102265/3838	1"7/8-12	1"7/8-12	58,5	-	57
38	1"1/2	SA102265/3850	1"7/8-12	2"1/2-12	72	-	57

FOR S.P.A. - NORME E DIMENSIONI SOGGETTE A MODIFICHE SENZA PREAVVISO.
FOR S.P.A. - DESIGN DETAILS AND SPECIFICATIONS SUBJECT TO CHANGE WITHOUT PRIOR NOTICE.



102276

Giunzione diretta maschio
JIC con 37° - sede a saldare
Braze connector male JIC

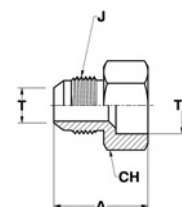

T		RIFERIMENTO REFERENCE	J	A	T ₁	CH
MM.	IN.		UNF-UN			
6	1/4	A102276/0606	7/16-20	26	6	14
8	5/16	A102276/0810	1/2-20	26	10	16
10	3/8	A102276/1010	9/16-18	27.5	10	19
10	3/8	A102276/1012	9/16-18	27.5	12	19
12	1/2	A102276/1212	3/4-16	29	12	22
12	1/2	A102276/1216	3/4-16	29	16	24
12	1/2	A102276/1218	3/4-16	29	18	24
14÷16	5/8	A102276/1616	7/8-14	31.5	16	24
14÷16	5/8	A102276/1618	7/8-14	31.5	18	24
14÷16	5/8	A102276/1622	7/8-14	36.5	22	30
18-20	3/4	A102276/2018	1" 1/16-12	40	18	30
18-20	3/4	A102276/2020	1" 1/16-12	40	20	30
18-20	3/4	A102276/2025	1" 1/16-12	40	25	32
25	1"	A102276/2525	1" 5/16-12	42	25	36
25	1"	A102276/2527	1" 5/16-12	42	27	36
25	1"	A102276/2532	1" 5/16-12	42.5	32	41
30-32	1" 1/4	A102276/3232	1" 5/8-12	45	32	46
30-32	1" 1/4	A102276/3238	1" 5/8-12	45	38	46
38	1" 1/2	A102276/3838	1" 7/8-12	50	38	50
6	1/4	SA102276/0610	7/16-20	26	10	16
10	3/8	SA102276/1013	9/16-18	27,5	13	19
12	1/2	SA102276/1208	3/4-16	29,5	8	22
12	1/2	SA102276/1210	3/4-16	29	10	21
12	1/2	SA102276/1214	3/4-16	29	14	22
12	1/2	SA102276/1215	3/4-16	29	15	22
12	1/2	SA102276/1217	3/4-16	29	17	24
12	1/2	SA102276/1220	3/4-16	29	20	24
14÷16	5/8	SA102276/1615	7/8-14	31,5	15	24
14÷16	5/8	SA102276/1620	7/8-14	37,5	20	30
14÷16	5/8	SA102276/1624	7/8-14	38,5	24	32
14÷16	5/8	SA102276/1626	7/8-14	38,5	26	32
18-20	3/4	SA102276/2022	1" 1/16-12	40	22	30
18-20	3/4	SA102276/2028	1" 1/16-12	40	28	36
22	7/8	SA102276/2220	1" 3/16-12	39,5	20	36
25	1"	SA102276/2520	1" 5/16-12	40,5	20	35
25	1"	SA102276/2530	1" 5/16-12	42	30	36
25	1"	SA102276/2545	1" 5/16-12	43	45	50
30-32	1" 1/4	SA102276/3228	1" 5/8-12	45	28	46
30-32	1" 1/4	SA102276/3234	1" 5/8-12	45	34	46

RACCORDI PER TUBI SVASATI - 37°

37° - FLARED TUBE CONNECTORS

102287

Giunzione diretta femmina
JIC cono 37° - sede a saldare
Braze connector female JIC

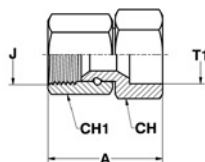

T		RIFERIMENTO REFERENCE	J	A	T ₁	CH	CH ₁
MM.	IN.		UNF-UN				
6	1/4	A102287/0606	7/16-20	30,5	6	14	14
8	5/16	A102287/0808	1/2-20	32	8	16	17
8	5/16	A102287/0810	1/2-20	31,5	10	16	17
10	3/8	A102287/1010	9/16-18	33,5	10	19	17
10	3/8	A102287/1012	9/16-18	33,5	12	19	17
12	1/2	A102287/1212	3/4-16	35	12	24	22
12	1/2	A102287/1216	3/4-16	35	16	24	22
12	1/2	A102287/1218	3/4-16	35	18	24	22
14÷16	5/8	A102287/1614	7/8-14	38	14	24	27
14÷16	5/8	A102287/1616	7/8-14	38	16	24	27
14÷16	5/8	A102287/1618	7/8-14	38	18	24	27
14÷16	5/8	A102287/1622	7/8-14	44	22	30	27
18-20	3/4	A102287/2018	1" 1/16-12	45,5	18	30	32
18-20	3/4	A102287/2020	1" 1/16-12	45,5	20	30	32
18-20	3/4	A102287/2025	1" 1/16-12	45,5	25	32	32
18-20	3/4	A102287/2027	1" 1/16-12	45,5	27	36	32
22	7/8	A102287/2222	1" 3/16-12	46	22	36	36
25	1"	A102287/2525	1" 5/16-12	49,5	25	36	38
25	1"	A102287/2527	1" 5/16-12	49	27	36	38
25	1"	A102287/2532	1" 5/16-12	49,5	32	41	38
25	1"	A102287/2534	1" 5/16-12	49,5	34	41	38
30-32	1" 1/4	A102287/3232	1" 5/8-12	53	32	46	50
30-32	1" 1/4	A102287/3238	1" 5/8-12	53	38	46	50
38	1" 1/2	A102287/3838	1" 7/8-12	61	38	50	57
10	3/8	SA102287/1008	9/16-18	33,5	8	19	17
10	3/8	SA102287/1013	9/16-18	33,5	13	19	17
10	3/8	SA102287/1022	9/16-18	39,5	22	30	17
12	1/2	SA102287/1208	3/4-16	34	8	22	22
12	1/2	SA102287/1217	3/4-16	35	17	24	22
14÷16	5/8	SA102287/1620	7/8-14	44	20	30	27
25	1"	SA102287/2530	1" 5/16-12	48,5	30	41	38
25	1"	SA102287/2535	1" 5/16-12	49,5	35	41	38



102353

Terminale dritto JIC
cono 37° - maschio
GAS cil. (BSPP)
con cono interno 60°
per sedi ISO 8434-6
Connector male
JIC - male BSPP 60°
ISO 8434-6 ports

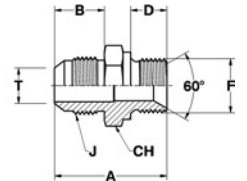

T		RIFERIMENTO REFERENCE	J	F	A	B	D	CH
MM.	IN.		UNF-UN	GAS CIL.BSPP				
6	1/4	A102353/0610	7/16-20	1/8	29	14	8	14
6	1/4	A102353/0613	7/16-20	1/4	34.5	14	12	19
6	1/4	A102353/0617	7/16-20	3/8	34.5	14	12	22
6	1/4	A102353/0621	7/16-20	1/2	38	14	14	27
8	5/16	A102353/0810	1/2-20	1/8	29	14	8	14
8	5/16	A102353/0813	1/2-20	1/4	34.5	14	12	19
8	5/16	A102353/0817	1/2-20	3/8	34.5	14	12	22
10	3/8	A102353/1013	9/16-18	1/4	34.5	14	12	19
10	3/8	A102353/1017	9/16-18	3/8	34.5	14	12	22
10	3/8	A102353/1021	9/16-18	1/2	38	14	14	27
12	1/2	A102353/1213	3/4-16	1/4	37.5	17	12	22
12	1/2	A102353/1217	3/4-16	3/8	37.5	17	12	22
12	1/2	A102353/1221	3/4-16	1/2	41	17	14	27
12	1/2	A102353/1226	3/4-16	3/4	45	17	16	32
14÷16	5/8	A102353/1617	7/8-14	3/8	40.5	19,5	12	24
14÷16	5/8	A102353/1621	7/8-14	1/2	43.5	19,5	14	27
14÷16	5/8	A102353/1626	7/8-14	3/4	47.5	19,5	16	32
18-20	3/4	A102353/2021	1" 1/16-12	1/2	47	22	14	30
18-20	3/4	A102353/2026	1" 1/16-12	3/4	50	22	16	32
18-20	3/4	A102353/2033	1" 1/16-12	1"	52.5	22	18	41
22	7/8	A102353/2226	1" 3/16-12	3/4	50.5	22,5	16	32
25	1"	A102353/2526	1" 5/16-12	3/4	51	23	16	36
25	1"	A102353/2533	1" 5/16-12	1"	53.5	23	18	41
25	1"	A102353/2542	1" 5/16-12	1" 1/4	57	23	20	50
30-32	1" 1/4	A102353/3233	1" 5/8-12	1"	55.5	24,5	18	42
30-32	1" 1/4	A102353/3242	1" 5/8-12	1" 1/4	58.5	24,5	20	50
38	1" 1/2	A102353/3842	1" 7/8-12	1" 1/4	61.5	27,5	20	50
38	1" 1/2	A102353/3848	1" 7/8-12	1" 1/2	65.5	27,5	22	60
8	5/16	SA102353/0821	1/2-20	1/2	38	14	14	27
10	3/8	SA102353/1010	9/16-18	1/8	30	14	8	17
10	3/8	SA102353/1026	9/16-18	3/4	42	14	16	32
14÷16	5/8	SA102353/1610	7/8-14	1/8	35,5	19,5	8	24
14÷16	5/8	SA102353/1613	7/8-14	1/4	40,5	19,5	12	24
14÷16	5/8	SA102353/1623	7/8-14	5/8	47,5	19,5	16	27
14÷16	5/8	SA102353/1633	7/8-14	1"	49,5	19,5	18	41
18-20	3/4	SA102353/2042	1" 1/16-12	1" 1/4	55,5	22	20	50
22	7/8	SA102353/2213	1" 3/16-12	1/4	46,5	22,5	12	32
22	7/8	SA102353/2221	1" 3/16-12	1/2	49	22,5	14	32
25	1"	SA102353/2548	1" 5/16-12	1" 1/2	61	23	22	55
30-32	1" 1/4	SA102353/3226	1" 5/8-12	3/4	53,5	24,5	16	42
30-32	1" 1/4	SA102353/3248	1" 5/8-12	1" 1/2	62,5	24,5	22	55

RACCORDI PER TUBI SVASATI - 37°

37° - FLARED TUBE CONNECTORS

102342

Portamanometro maschio
JIC cono 37° - femmina
GAS cil. (BSPP)
*Manometer connector
male JIC - female BSPP*

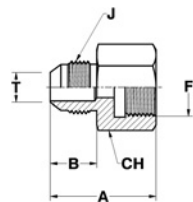

T		RIFERIMENTO REFERENCE	J	F	A	B	CH
MM.	IN.		UNF-UN	GAS CIL.BSPP			
6	1/4	A102342/0613	7/16-20	1/4	31	14	19
6	1/4	A102342/0621	7/16-20	1/2	41	14	27
8	5/16	A102342/0813	1/2-20	1/4	28	14	19
8	5/16	A102342/0821	1/2-20	1/2	41	14	27
10	3/8	A102342/1013	9/16-18	1/4	28	14	19
10	3/8	A102342/1021	9/16-18	1/2	35	14	27
12	1/2	A102342/1213	3/4-16	1/4	31	17	22
12	1/2	A102342/1221	3/4-16	1/2	38	17	27
12	1/2	SA102342/1217	3/4-16	3/8	35	17	24
14÷16	5/8	SA102342/1621	7/8-14	1/2	40	19,5	27

102298

Portamanometro femmina
JIC cono 37° - femmina
GAS cil. (BSPP)
*Manometer connector
female JIC - male BSPP*

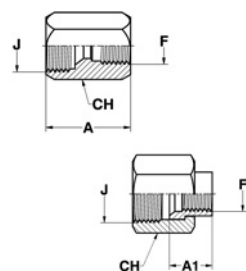

RIFERIMENTO REFERENCE	J	F	A	A ₁	CH
	UNF-UN	GAS CIL.BSPP			
A102298/0613	7/16-20	1/4	29.5	-	19
A102298/0813	1/2-20	1/4	28.5	-	19
A102298/1013	9/16-18	1/4	30	-	19
A102298/1213	3/4-16	1/4	32	-	22
A102298/1613	7/8-14	1/4	-	17	27
A102298/2013	1" 1/16-12	1/4	-	18	32
A102298/2213	1" 3/16-12	1/4	-	19	36
A102298/2513	1" 5/16-12	1/4	-	20	38
A102298/3213	1" 5/8-12	1/4	-	20	50
A102298/3813	1" 7/8-12	1/4	-	24	57



T		RIFERIMENTO REFERENCE	J	A	CH
MM.	IN.		<small>UNF-UN</small>		
6	1/4	A101022/06	7/16-20	20,5	13
8	5/16	A101022/08	1/2-20	20,5	14
10	3/8	A101022/10	9/16-18	21,5	16
12	1/2	A101022/12	3/4-16	24,5	21
14÷16	5/8	A101022/16	7/8-14	28	24
18-20	3/4	A101022/20	1" 1/16-12	32,5	30
22	7/8	A101022/22	1" 3/16-12	33	32
25	1"	A101022/25	1" 5/16-12	34	35
30-32	1" 1/4	A101022/32	1" 5/8-12	37	42
38	1" 1/2	A101022/38	1" 7/8-12	42	50
50	2"	SA101022/50	2" 1/2-12	52	70

101022

Tappo maschio JIC
JIC Male plug

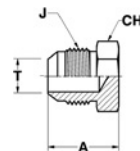

T		RIFERIMENTO REFERENCE	J	A	CH
MM.	IN.		<small>UNF-UN</small>		
6	1/4	A101033/06	7/16-20	18	14
8	5/16	A101033/08	1/2-20	20,5	17
10	3/8	A101033/10	9/16-18	22	17
12	1/2	A101033/12	3/4-16	24,5	22
14÷16	5/8	A101033/16	7/8-14	28	27
18-20	3/4	A101033/20	1" 1/16-12	30	32
22	7/8	A101033/22	1" 3/16-12	31	36
25	1"	A101033/25	1" 5/16-12	33,5	41
30-32	1" 1/4	A101033/32	1" 5/8-12	35	50
38	1" 1/2	A101033/38	1" 7/8-12	40,5	57

101033

Tappo femmina JIC
JIC Female plug

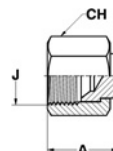

RACCORDI PER TUBI SVASATI - 37°

37° - FLARED TUBE CONNECTORS

103002

Giunzione diretta passaparatia
JIC cono 37° - JIC cono 37°
Bulkhead union male
JIC - JIC

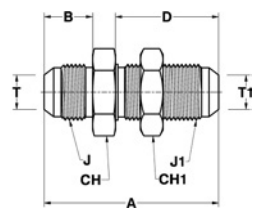

T		T ₁		RIFERIMENTO REFERENCE	J	J ₁	A	B	D	CH	CH ₁
MM.	IN.	MM.	IN.		UNF-UN	UNF-UN					
6	1/4	6	1/4	A103002/06	7/16-20	7/16-20	52,5	14	31,5	17	17
8	5/16	8	5/16	A103002/08	1/2-20	1/2-20	52,5	14	31,5	19	19
10	3/8	10	3/8	A103002/10	9/16-18	9/16-18	55,5	14	33,5	22	22
12	1/2	12	1/2	A103002/12	3/4-16	3/4-16	62	17	37,5	24	24
14÷16	5/8	14÷16	5/8	A103002/16	7/8-14	7/8-14	69,5	19,5	41	30	30
18-20	3/4	18-20	3/4	A103002/20	1" 1/16-12	1" 1/16-12	78,5	22	45,5	36	36
22	7/8	22	7/8	A103002/22	1" 3/16-12	1" 3/16-12	79	22,5	45,5	38	38
25	1"	25	1"	A103002/25	1" 5/16-12	1" 5/16-12	80	23	45,5	41	41
30-32	1" 1/4	30-32	1" 1/4	A103002/32	1" 5/8-12	1" 5/8-12	84	24,5	46,5	50	50
38	1" 1/2	38	1" 1/2	A103002/38	1" 7/8-12	1" 7/8-12	89,5	27,5	47	55	55
50	2"	50	2"	A103002/50	2" 1/2-12	2" 1/2-12	106,5	34	54	70	70
10	3/8	6	1/4	SA103002/1006	9/16-18	7/16-20	53,5	14	31,5	22	17
14÷16	5/8	12	1/2	SA103002/1612	7/8-14	3/4-16	66	19,5	37,5	30	24

103013

Giunzione diretta passaparatia
JIC cono 37° - femmina NPTF
Bulkhead union male
JIC - female NPTF

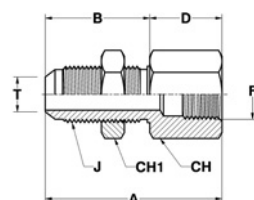

T		RIFERIMENTO REFERENCE		J	F	A	B	D	CH	CH ₁
MM.	IN.			UNF-UN	NPTF					
6	1/4	A103013/0610		7/16-20	1/8	47,5	31,5	16	17	17
6	1/4	A103013/0613		7/16-20	1/4	53	31,5	21,5	19	17
8	5/16	A103013/0810		1/2-20	1/8	47,5	31,5	16	19	19
8	5/16	A103013/0813		1/2-20	1/4	53	31,5	21,5	19	19
10	3/8	A103013/1010		9/16-18	1/8	49,5	33,5	16	22	22
10	3/8	A103013/1013		9/16-18	1/4	55	33,5	21,5	22	22
10	3/8	A103013/1017		9/16-18	3/8	56	33,5	22,5	22	22
12	1/2	A103013/1213		3/4-16	1/4	59	37,5	21,5	24	24
12	1/2	A103013/1217		3/4-16	3/8	60	37,5	22,5	24	24
12	1/2	A103013/1221		3/4-16	1/2	66	37,5	28,5	30	24
14÷16	5/8	A103013/1621		7/8-14	1/2	69,5	41	28,5	30	30
18-20	3/4	A103013/2021		1" 1/16-12	1/2	74	45,5	28,5	36	36
18-20	3/4	A103013/2026		1" 1/16-12	3/4	76	45,5	30,5	36	36
22	7/8	A103013/2226		1" 3/16-12	3/4	76	45,5	30,5	38	38
25	1"	A103013/2533		1" 5/16-12	1"	82	45,5	36,5	41	41
30-32	1" 1/4	A103013/3242		1" 5/8-12	1" 1/4	85	46,5	38,5	50	50
38	1" 1/2	A103013/3848		1" 7/8-12	1" 1/2	86	47	39	60	55



T		RIFERIMENTO REFERENCE	J	F	A	B	D	CH
MM.	IN.		UNF-UN	UNF-UN				
6	1/4	A104014/0611	7/16-20	7/16-20	52.5	35	9	14
6	1/4	A104014/0612	7/16-20	1/2-20	52.5	35	9	16
6	1/4	A104014/0614	7/16-20	9/16-18	54.5	35	10	18
8	5/16	A104014/0812	1/2-20	1/2-20	54.5	37	9	16
10	3/8	A104014/1014	9/16-18	9/16-18	58.7	39	10	18
10	3/8	A104014/1019	9/16-18	3/4-16	60	39	11	22
12	1/2	A104014/1219	3/4-16	3/4-16	68.5	48	11	22
12	1/2	A104014/1222	3/4-16	7/8-14	71.5	48	13	27
12	1/2	A104014/1227	3/4-16	1" 1/16-12	76	48	15	32
14÷16	5/8	A104014/1619	7/8-14	3/4-16	74.5	53	11	24
14÷16	5/8	A104014/1622	7/8-14	7/8-14	77	53	13	27
14÷16	5/8	A104014/1627	7/8-14	1" 1/16-12	81.5	53	15	32
18-20	3/4	A104014/2019	1" 1/16-12	3/4-16	86.5	63	11	27
18-20	3/4	A104014/2022	1" 1/16-12	7/8-14	88	63	13	27
18-20	3/4	A104014/2027	1" 1/16-12	1" 1/16-12	91.5	63	15	32
18-20	3/4	A104014/2033	1" 1/16-12	1" 5/16-12	92.5	63	15	38
22	7/8	A104014/2230	1" 3/16-12	1" 3/16-12	96.5	68	15	35
25	1"	A104014/2527	1" 5/16-12	1" 1/16-12	100	72	15	35
25	1"	A104014/2533	1" 5/16-12	1" 5/16-12	101	72	15	38
25	1"	A104014/2541	1" 5/16-12	1" 5/8-12	102	72	15	48
30-32	1" 1/4	A104014/3241	1" 5/8-12	1" 5/8-12	119	88	15	48
38	1" 1/2	A104014/3848	1" 7/8-12	1" 7/8-12	131	98	15	55

104014

Prolunga dritta
JIC cono 37° - SAE UNF-UN
per sedi ISO 11926
Long connector male
JIC - male SAE UNF-UN
with O.R. ISO 11926 ports

SEDI PAG.30 / PORTS PAG.30

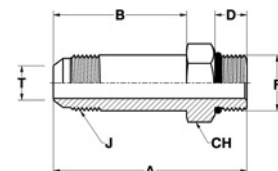

RACCORDI PER TUBI SVASATI - 37°

37° - FLARED TUBE CONNECTORS

104025

Prolunga diritta
JIC cono 37° - GAS cil. (BSPP)
con O.R. e rondella
per sedi ISO 1179
*Long connector male
JIC - male BSPP
with O.R. and retaining ring
ISO 1179 ports*

SEDI PAG.32 / PORTS PAG.32

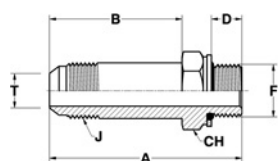

T		RIFERIMENTO REFERENCE	J	F	A	B	D	CH
MM.	IN.		UNF-UN	GAS CIL-BSPP				
6	1/4	A104025/0610	7/16-20	1/8	50	35	7	14
6	1/4	A104025/0613	7/16-20	1/4	55.5	35	10	19
6	1/4	A104025/0617	7/16-20	3/8	55.5	35	10	24
6	1/4	A104025/0621	7/16-20	1/2	59	35	12	27
8	5/16	A104025/0810	1/2-20	1/8	52	37	7	14
8	5/16	A104025/0813	1/2-20	1/4	57.5	37	10	19
8	5/16	A104025/0817	1/2-20	3/8	57.5	37	10	24
10	3/8	A104025/1013	9/16-18	1/4	59.5	39	10	19
10	3/8	A104025/1017	9/16-18	3/8	59.5	39	10	24
10	3/8	A104025/1021	9/16-18	1/2	63	39	12	27
12	1/2	A104025/1213	3/4-16	1/4	68.5	48	10	22
12	1/2	A104025/1217	3/4-16	3/8	68.5	48	10	24
12	1/2	A104025/1221	3/4-16	1/2	72	48	12	27
12	1/2	A104025/1226	3/4-16	3/4	76	48	14	36
14÷16	5/8	A104025/1617	7/8-14	3/8	74	53	10	24
14÷16	5/8	A104025/1621	7/8-14	1/2	77	53	12	27
14÷16	5/8	A104025/1626	7/8-14	3/4	81	53	14	36
18-20	3/4	A104025/2021	1" 1/16-12	1/2	88	63	12	30
18-20	3/4	A104025/2026	1" 1/16-12	3/4	91	63	14	36
18-20	3/4	A104025/2033	1" 1/16-12	1"	93.5	63	15,5	41
22	7/8	A104025/2226	1" 3/16-12	3/4	96	68	14	36
25	1"	A104025/2526	1" 5/16-12	3/4	100	72	14	36
25	1"	A104025/2533	1" 5/16-12	1"	102	72	15,5	41
25	1"	A104025/2542	1" 5/16-12	1" 1/4	106	72	17,5	50
30-32	1" 1/4	A104025/3233	1" 5/8-12	1"	119	88	15,5	42
30-32	1" 1/4	A104025/3242	1" 5/8-12	1" 1/4	122	88	17,5	50
38	1" 1/2	A104025/3842	1" 7/8-12	1" 1/4	132	98	17,5	50
38	1" 1/2	A104025/3848	1" 7/8-12	1" 1/2	136	98	19,5	60



T		RIFERIMENTO REFERENCE	J	F	A	B	D	CH
MM.	IN.							
6	1/4	A104124/0610	7/16-20	1/8	51	35	9	14
6	1/4	A104124/0613	7/16-20	1/4	55.5	35	12	19
8	5/16	A104124/0813	1/2-20	1/4	57.5	37	12	19
8	5/16	A104124/0817	1/2-20	3/8	57.5	37	12	24
10	3/8	A104124/1013	9/16-18	1/4	59.5	39	12	19
10	3/8	A104124/1017	9/16-18	3/8	59.5	39	12	24
10	3/8	A104124/1021	9/16-18	1/2	65	39	16	27
12	1/2	A104124/1213	3/4-16	1/4	68.5	48	12	22
12	1/2	A104124/1217	3/4-16	3/8	68.5	48	12	24
12	1/2	A104124/1221	3/4-16	1/2	74	48	16	27
14÷16	5/8	A104124/1617	7/8-14	3/8	74	53	12	24
14÷16	5/8	A104124/1621	7/8-14	1/2	79	53	16	27
14÷16	5/8	A104124/1626	7/8-14	3/4	82	53	17	36
18-20	3/4	A104124/2021	1" 1/16-12	1/2	90	63	16	30
18-20	3/4	A104124/2026	1" 1/16-12	3/4	92	63	17	36
18-20	3/4	A104124/2033	1" 1/16-12	1"	95,5	63	20	41
25	1"	A104124/2526	1" 5/16-12	3/4	101	72	17	36
25	1"	A104124/2533	1" 5/16-12	1"	104	72	20	41
25	1"	A104124/2542	1" 5/16-12	1" 1/4	106	72	20	50
30-32	1" 1/4	A104124/3233	1" 5/8-12	1"	121	88	20	42
30-32	1" 1/4	A104124/3242	1" 5/8-12	1" 1/4	122	88	20	50
38	1" 1/2	A104124/3842	1" 7/8-12	1" 1/4	132	98	20	50
38	1" 1/2	A104124/3848	1" 7/8-12	1" 1/2	134	98	20	60

104124

Prolunga diritta
JIC cono 37° - GAS cil. (JIS)
con O.R. per sedi JIS 2351
Long connector male
JIC - male JIS
with O.R. JIS 2351 ports

SEDI PAG.31 / PORTS PAG.31

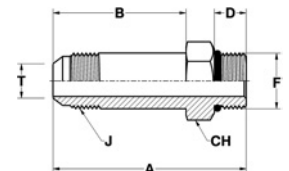

T		RIFERIMENTO REFERENCE	J	F	A	B	D	CH
MM.	IN.							
6	1/4	A104058/0610	7/16-20	10x1	51	35	8,5	14
6	1/4	A104058/0612	7/16-20	12x1,5	53.5	37	9,5	17
8	5/16	A104058/0810	1/2-20	10x1	53	37	8,5	14
8	5/16	A104058/0812	1/2-20	12x1,5	55.5	37	9,5	17
8	5/16	A104058/0814	1/2-20	14x1,5	56.5	37	9,5	19
10	3/8	A104058/1014	9/16-18	14x1,5	58.5	39	9,5	19
10	3/8	A104058/1016	9/16-18	16x1,5	60	39	11	22
12	1/2	A104058/1216	3/4-16	16x1,5	69	48	11	22
12	1/2	A104058/1218	3/4-16	18x1,5	70.5	48	12,5	24
14÷16	5/8	A104058/1618	7/8-14	18x1,5	75.5	53	12,5	24
14÷16	5/8	A104058/1620	7/8-14	20x1,5	76.5	53	12,5	27
14÷16	5/8	A104058/1622	7/8-14	22x1,5	78	53	13,5	27
18-20	3/4	A104058/2022	1" 1/16-12	22x1,5	89	63	13,5	30
18-20	3/4	A104058/2027	1" 1/16-12	27x2	92.5	63	16,5	32
22	7/8	A104058/2226	1" 3/16-12	26x1,5	94.5	68	14	36
25	1"	A104058/2527	1" 5/16-12	27x2	102	72	16,5	36
25	1"	A104058/2533	1" 5/16-12	33x2	102.5	72	16,5	41
30-32	1" 1/4	A104058/3242	1" 5/8-12	42x2	121	88	17	50
38	1" 1/2	A104058/3848	1" 7/8-12	48x2	136	88	19,5	60

104058

Prolunga diritta
JIC cono 37° - Metrico cil.
con O.R. e rondella
per sedi ISO 9974
Long connector male
JIC - male Metric
with O.R. and retaining ring
ISO 9974 ports

SEDI PAG.32 / PORTS PAG.32

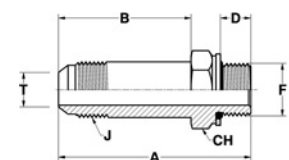

RACCORDI PER TUBI SVASATI - 37°

37° - FLARED TUBE CONNECTORS

104092

Prolunga diritta
JIC cono 37° - Metrico cil.
con O.R. per sedi ISO 6149
*Long connector male
JIC - male Metric
with O.R. ISO 6149 ports*

SEDI PAG.30 / PORTS PAG.30

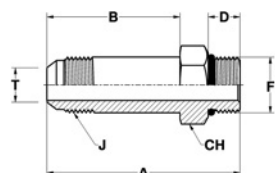

T		RIFERIMENTO REFERENCE	J	F	A	B	D	CH
MM.	IN.		UNF-UN	METRICO METRIC				
6	1/4	A104092/0610	7/16-20	10x1	51	35	9,5	14
8	5/16	A104092/0810	1/2-20	10x1	53	37	9,5	14
8	5/16	A104092/0812	1/2-20	12x1,5	55,5	37	11	17
8	5/16	A104092/0814	1/2-20	14x1,5	56,5	37	11	19
10	3/8	A104092/1014	9/16-18	14x1,5	58,5	39	11	19
10	3/8	A104092/1016	9/16-18	16x1,5	60	39	12,5	22
12	1/2	A104092/1216	3/4-16	16x1,5	69	48	12,5	22
12	1/2	A104092/1218	3/4-16	18x1,5	70,5	48	14	24
14÷16	5/8	A104092/1618	7/8-14	18x1,5	75,5	53	14	24
14÷16	5/8	A104092/1622	7/8-14	22x1,5	78	53	15	27
18-20	3/4	A104092/2022	1" 1/16-12	22x1,5	89	63	15	30
18-20	3/4	A104092/2027	1" 1/16-12	27x2	92,5	63	18,5	32
25	1"	A104092/2527	1" 5/16-12	27x2	102	72	18,5	36
25	1"	A104092/2533	1" 5/16-12	33x2	102,5	72	18,5	41
30-32	1" 1/4	A104092/3242	1" 5/8-12	42x2	121	88	19	50
38	1" 1/2	A104092/3848	1" 7/8-12	48x2	136	98	21,5	60

105004

Giunzione 45° maschio
JIC cono 37° - femmina
JIC cono 37°
*45° elbow union male
JIC - swivel female JIC*

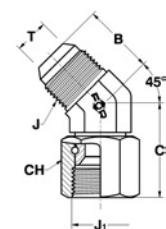

T		RIFERIMENTO REFERENCE	J	J ₁	B	C	CH
MM.	IN.		UNF-UN	UNF-UN			
6	1/4	A105004/06	7/16-20	7/16-20	18	24,5	14
8	5/16	A105004/08	1/2-20	1/2-20	19,5	26,5	17
10	3/8	A105004/10	9/16-18	9/16-18	21	29,5	17
12	1/2	A105004/12	3/4-16	3/4-16	25	32	22
14÷16	5/8	A105004/16	7/8-14	7/8-14	28	37	27
18-20	3/4	A105004/20	1" 1/16-12	1" 1/16-12	32,5	38,5	32
22	7/8	A105004/22	1" 3/16-12	1" 3/16-12	35	42	36
25	1"	A105004/25	1" 5/16-12	1" 5/16-12	37	45	38
30-32	1" 1/4	A105004/32	1" 5/8-12	1" 5/8-12	40,5	51,5	50
38	1" 1/2	A105004/38	1" 7/8-12	1" 7/8-12	45	57,5	57
50	2"	A105004/50	2" 1/2-12	2" 1/2-12	56,5	74	75
10	3/8	SA105004/1008	9/16-18	1/2-20	21	28,5	17



105015

T		RIFERIMENTO REFERENCE	J	F	B	C	CH
MM.	IN.		UNF-UN	UNF-UN			
6	1/4	A105015/0611	7/16-20	7/16-20	18	26.5	14
6	1/4	A105015/0612	7/16-20	1/2-20	19,5	26.5	17
6	1/4	A105015/0614	7/16-20	9/16-18	21	29	17
8	5/16	A105015/0812	1/2-20	1/2-20	19,5	26.5	17
10	3/8	A105015/1014	9/16-18	9/16-18	21	29	17
10	3/8	A105015/1019	9/16-18	3/4-16	22	33	22
12	1/2	A105015/1219	3/4-16	3/4-16	25	33	22
12	1/2	A105015/1222	3/4-16	7/8-14	25.5	38.5	27
12	1/2	A105015/1227	3/4-16	1" 1/16-12	27.5	44	32
14÷16	5/8	A105015/1619	7/8-14	3/4-16	28	35	22
14÷16	5/8	A105015/1622	7/8-14	7/8-14	28	38.5	27
14÷16	5/8	A105015/1627	7/8-14	1" 1/16-12	30	44	32
18-20	3/4	A105015/2019	1" 1/16-12	3/4-16	32.5	37	22
18-20	3/4	A105015/2022	1" 1/16-12	7/8-14	32.5	40.5	27
18-20	3/4	A105015/2027	1" 1/16-12	1" 1/16-12	32.5	44	32
18-20	3/4	A105015/2033	1" 1/16-12	1" 5/16-12	35.5	47	38
22	7/8	A105015/2230	1" 3/16-12	1" 3/16-12	35	45.5	35
25	1"	A105015/2527	1" 5/16-12	1" 1/16-12	37	47	32
25	1"	A105015/2533	1" 5/16-12	1" 5/16-12	37	47	38
25	1"	A105015/2541	1" 5/16-12	1" 5/8-12	39	48.5	50
30-32	1" 1/4	A105015/3241	1" 5/8-12	1" 5/8-12	40.5	48.5	50
38	1" 1/2	A105015/3848	1" 7/8-12	1" 7/8-12	45	48.5	55
8	5/16	SA105015/0814	1/2-20	9/16-18	21	29	17
10	3/8	SA105015/1011	9/16-18	7/16-20	21	27.5	14
10	3/8	SA105015/1012	9/16-18	1/2-20	21	27.5	17
12	1/2	SA105015/1214	3/4-16	9/16-18	25	30	17
30-32	1" 1/4	SA105015/3233	1" 5/8-12	1" 5/16-12	40.5	48.5	38

Terminale orientabile 45°
JIC cono 37° - SAE UNF-UN
per sedi ISO 11926
45° (AD) elbow male
JIC - male SAE UNF-UN
with O.R. ISO 11926 ports
SEDI PAG.30 / PORTS PAG.30

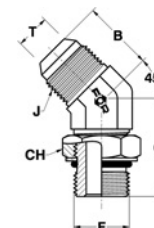

RACCORDI PER TUBI SVASATI - 37°

37° - FLARED TUBE CONNECTORS

105026

Terminale orientabile 45°
 JIC cono 37° - GAS cil. (BSPP)
 con O.R. e rondella
 per sedi ISO 1179
 45° (AD) elbow male
 JIC - male BSPP
 with O.R. and retaining ring
 ISO 1179 ports

SEDI PAG.32 / PORTS PAG.32

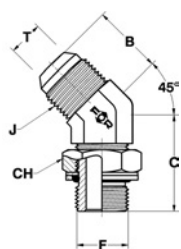

T		RIFERIMENTO REFERENCE	J	F	B	C	CH
MM.	IN.		UNF-UN	GAS CIL-BSPP			
6	1/4	A105026/0610	7/16-20	1/8	18	26.5	14
6	1/4	A105026/0613	7/16-20	1/4	21	29	19
6	1/4	A105026/0617	7/16-20	3/8	22	33	22
6	1/4	A105026/0621	7/16-20	1/2	22.5	38.5	27
8	5/16	A105026/0810	1/2-20	1/8	19.5	26.5	14
8	5/16	A105026/0813	1/2-20	1/4	21	29	19
8	5/16	A105026/0817	1/2-20	3/8	22	33	22
10	3/8	A105026/1013	9/16-18	1/4	21	29	19
10	3/8	A105026/1017	9/16-18	3/8	22	33	22
10	3/8	A105026/1021	9/16-18	1/2	22.5	38.5	27
12	1/2	A105026/1213	3/4-16	1/4	25	30	19
12	1/2	A105026/1217	3/4-16	3/8	25	33	22
12	1/2	A105026/1221	3/4-16	1/2	25.5	38.5	27
12	1/2	A105026/1226	3/4-16	3/4	27.5	44	36
14÷16	5/8	A105026/1617	7/8-14	3/8	28	35	22
14÷16	5/8	A105026/1621	7/8-14	1/2	28	38.5	27
14÷16	5/8	A105026/1626	7/8-14	3/4	30	44	36
18-20	3/4	A105026/2021	1" 1/16-12	1/2	32.5	40.5	27
18-20	3/4	A105026/2026	1" 1/16-12	3/4	32.5	44	36
18-20	3/4	A105026/2033	1" 1/16-12	1"	35.5	47	41
22	7/8	A105026/2226	1" 3/16-12	3/4	35	45.5	36
25	1"	A105026/2526	1" 5/16-12	3/4	37	47	36
25	1"	A105026/2533	1" 5/16-12	1"	37	47	41
25	1"	A105026/2542	1" 5/16-12	1" 1/4	39	48.5	50
30-32	1" 1/4	A105026/3233	1" 5/8-12	1"	40.5	48.5	41
30-32	1" 1/4	A105026/3242	1" 5/8-12	1" 1/4	40.5	48.5	50
38	1" 1/2	A105026/3842	1" 7/8-12	1" 1/4	45	48.5	50
38	1" 1/2	A105026/3848	1" 7/8-12	1" 1/2	45	48.5	60
10	3/8	SA105026/1026	9/16-18	3/4	25	44	36
18-20	3/4	SA105026/2023	1" 1/16-12	5/8	32.5	40.5	30



105093

T		RIFERIMENTO REFERENCE	J	F	B	C	CH
MM.	IN.		UNF-UN	GAS CIL-JIS			
6	1/4	A105093/0610	7/16-20	1/8	18	26.5	14
6	1/4	A105093/0613	7/16-20	1/4	21	29	19
6	1/4	A105093/0617	7/16-20	3/8	22	33	22
6	1/4	A105093/0621	7/16-20	1/2	22.5	38.5	27
8	5/16	A105093/0810	1/2-20	1/8	19,5	26.5	14
8	5/16	A105093/0813	1/2-20	1/4	21	29	19
8	5/16	A105093/0817	1/2-20	3/8	22	33	22
10	3/8	A105093/1013	9/16-18	1/4	21	29	19
10	3/8	A105093/1017	9/16-18	3/8	22	33	22
10	3/8	A105093/1021	9/16-18	1/2	22.5	38.5	27
10	3/8	A105093/1026	9/16-18	3/4	25	44	36
12	1/2	A105093/1213	3/4-16	1/4	25	30	19
12	1/2	A105093/1217	3/4-16	3/8	25	33	22
12	1/2	A105093/1221	3/4-16	1/2	25.5	38.5	27
12	1/2	A105093/1226	3/4-16	3/4	27.5	44	36
14÷16	5/8	A105093/1617	7/8-14	3/8	28	35	22
14÷16	5/8	A105093/1621	7/8-14	1/2	28	38.5	27
14÷16	5/8	A105093/1626	7/8-14	3/4	30	44	36
18-20	3/4	A105093/2021	1" 1/16-12	1/2	32.5	40.5	27
18-20	3/4	A105093/2026	1" 1/16-12	3/4	32.5	44	36
18-20	3/4	A105093/2033	1" 1/16-12	1"	35.5	47	41
22	7/8	A105093/2226	1" 3/16-12	3/4	35	45.5	36
25	1"	A105093/2526	1" 5/16-12	3/4	37	47	36
25	1"	A105093/2533	1" 5/16-12	1"	37	47	41
25	1"	A105093/2542	1" 5/16-12	1" 1/4	39	48.5	50
30-32	1" 1/4	A105093/3233	1" 5/8-12	1"	40.5	48.5	41
30-32	1" 1/4	A105093/3242	1" 5/8-12	1" 1/4	40.5	48.5	50
38	1" 1/2	A105093/3842	1" 7/8-12	1" 1/4	45	48.5	50
38	1" 1/2	A105093/3848	1" 7/8-12	1" 1/2	45	48.5	55

Terminale orientabile 45°
JIC cono 37° - GAS cil. (JIS)
con O.R. per sedi JIS 2351
45° (AD) elbow male
JIC - male JIS
with O.R. JIS 2351 ports
SEDI PAG.31 / PORTS PAG.31

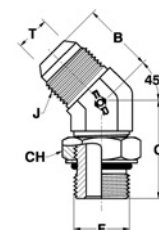

RACCORDI PER TUBI SVASATI - 37°

37° - FLARED TUBE CONNECTORS

105037

Terminale orientabile 45° JIC cono 37° - Metrico cil. con O.R. e rondella per sedi ISO 9974
 45° (ADJ) elbow male JIC - male Metric with O.R. and retaining ring ISO 9974 ports

SEDI PAG.32 / PORTS PAG.32

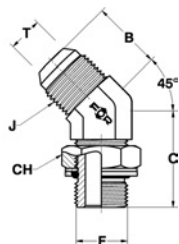

T		RIFERIMENTO REFERENCE	J	F	B	C	CH
MM.	IN.		UNF-UN	METRICO METRIC			
6	1/4	A105037/0610	7/16-20	10x1	18	26.5	14
6	1/4	A105037/0612	7/16-20	12x1,5	21	29	17
8	5/16	A105037/0810	1/2-20	10x1	19,5	26.5	14
8	5/16	A105037/0812	1/2-20	12x1,5	21	29	17
8	5/16	A105037/0814	1/2-20	14x1,5	21	29	19
10	3/8	A105037/1014	9/16-18	14x1,5	21	29	19
10	3/8	A105037/1016	9/16-18	16x1,5	22	33	22
12	1/2	A105037/1214	3/4-16	14x1,5	25	31.5	19
12	1/2	A105037/1216	3/4-16	16x1,5	25	33	22
12	1/2	A105037/1218	3/4-16	18x1,5	25	34	24
14÷16	5/8	A105037/1618	7/8-14	18x1,5	28	35	24
14÷16	5/8	A105037/1620	7/8-14	20x1,5	28	38.5	27
14÷16	5/8	A105037/1622	7/8-14	22x1,5	28	38.5	27
18-20	3/4	A105037/2022	1" 1/16-12	22x1,5	32.5	40.5	27
18-20	3/4	A105037/2027	1" 1/16-12	27x2	32.5	44	32
22	7/8	A105037/2226	1" 3/16-12	26x1,5	35	45.5	36
25	1"	A105037/2527	1" 5/16-12	27x2	37	47	32
25	1"	A105037/2533	1" 5/16-12	33x2	37	47	41
30-32	1" 1/4	A105037/3242	1" 5/8-12	42x2	40.5	48.5	50
38	1" 1/2	A105037/3848	1" 7/8-12	48x2	45	55	55
6	1/4	SA105037/0614	7/16-20	14x1,5	21	29	19
10	3/8	SA105037/1018	9/16-18	18x1,5	22.5	35	24
12	1/2	SA105037/1220	3/4-16	20x1,5	25	38.5	27



105082

T		RIFERIMENTO REFERENCE	J	F	B	C	CH
MM.	IN.		UNF-UN	METRICO METRIC			
6	1/4	A105082/0610	7/16-20	10x1	18	26.5	14
6	1/4	A105082/0612	7/16-20	12x1,5	21	29	17
8	5/16	A105082/0810	1/2-20	10x1	19,5	26.5	14
8	5/16	A105082/0812	1/2-20	12x1,5	21	29	17
8	5/16	A105082/0814	1/2-20	14x1,5	21	29	19
10	3/8	A105082/1014	9/16-18	14x1,5	21	29	19
10	3/8	A105082/1016	9/16-18	16x1,5	22	33	22
12	1/2	A105082/1214	3/4-16	14x1,5	25	31.5	19
12	1/2	A105082/1216	3/4-16	16x1,5	25	33	22
12	1/2	A105082/1218	3/4-16	18x1,5	25	34	24
14÷16	5/8	A105082/1618	7/8-14	18x1,5	28	35	24
14÷16	5/8	A105082/1622	7/8-14	22x1,5	28	38.5	27
18-20	3/4	A105082/2022	1" 1/16-12	22x1,5	32.5	40.5	27
18-20	3/4	A105082/2027	1" 1/16-12	27x2	32.5	44	32
25	1"	A105082/2527	1" 5/16-12	27x2	37	47	32
25	1"	A105082/2533	1" 5/16-12	33x2	37	47	41
30-32	1" 1/4	A105082/3242	1" 5/8-12	42x2	40.5	48.5	50
38	1" 1/2	A105082/3848	1" 7/8-12	48x2	45	55	55
6	1/4	SA105082/0614	7/16-20	14x1,5	21	29	19
10	3/8	SA105082/1018	9/16-18	18x1,5	22.5	35	24
12	1/2	SA105082/1220	3/4-16	20x1,5	25	38.5	27

Terminale orientabile 45°
JIC cono 37° - Metrico cil.
con O.R. per sedi ISO 6149
45° (AD) elbow male
JIC - male Metric
with O.R. ISO 6149 ports
SEDI PAG.30 / PORTS PAG.30

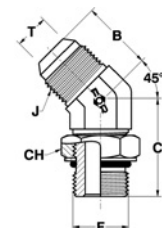

RACCORDI PER TUBI SVASATI - 37°

37° - FLARED TUBE CONNECTORS

105048

Terminale 45°
 JIC cono 37° - NPTF
 per sedi SAE 476
 45° elbow male
 JIC - male NPTF taper
 SAE 476 ports

SEDI PAG.35 / PORTS PAG.35

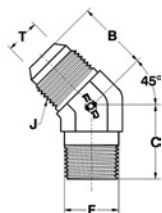

T		RIFERIMENTO REFERENCE	J	F	B	C
MM.	IN.		UNF-UN	NPTF		
6	1/4	A105048/0610	7/16-20	1/8	18	16
6	1/4	A105048/0613	7/16-20	1/4	21	21.5
8	5/16	A105048/0810	1/2-20	1/8	19,5	16
8	5/16	A105048/0813	1/2-20	1/4	21	21.5
10	3/8	A105048/1010	9/16-18	1/8	21	17.5
10	3/8	A105048/1013	9/16-18	1/4	21	21.5
10	3/8	A105048/1017	9/16-18	3/8	22	24
10	3/8	A105048/1021	9/16-18	1/2	22.5	29.5
12	1/2	A105048/1213	3/4-16	1/4	25	24
12	1/2	A105048/1217	3/4-16	3/8	25	24
12	1/2	A105048/1221	3/4-16	1/2	25.5	29.5
12	1/2	A105048/1226	3/4-16	3/4	27.5	30.5
14÷16	5/8	A105048/1617	7/8-14	3/8	28	24.5
14÷16	5/8	A105048/1621	7/8-14	1/2	28	29.5
14÷16	5/8	A105048/1626	7/8-14	3/4	30	30.5
18-20	3/4	A105048/2021	1" 1/16-12	1/2	32.5	30.5
18-20	3/4	A105048/2026	1" 1/16-12	3/4	32.5	30.5
22	7/8	A105048/2226	1" 3/16-12	3/4	35	32
25	1"	A105048/2526	1" 5/16-12	3/4	37	32.5
25	1"	A105048/2533	1" 5/16-12	1"	37	37.5
30-32	1" 1/4	A105048/3233	1" 5/8-12	1"	40.5	42
30-32	1" 1/4	A105048/3242	1" 5/8-12	1" 1/4	40.5	42.5
38	1" 1/2	A105048/3848	1" 7/8-12	1" 1/2	45	45
6	1/4	SA105048/0617	7/16-20	3/8	22	24
18-20	3/4	SA105048/2033	1" 1/16-12	1"	36	37.5



105059

T		RIFERIMENTO REFERENCE	J	F	B	C
MM.	IN.		UNF-UN	GAS CON.BSPT		
6	1/4	A105059/0610	7/16-20	1/8	20	16
6	1/4	A105059/0613	7/16-20	1/4	21	21.5
8	5/16	A105059/0810	1/2-20	1/8	20	16
8	5/16	A105059/0813	1/2-20	1/4	21	21.5
10	3/8	A105059/1013	9/16-18	1/4	21	21.5
10	3/8	A105059/1017	9/16-18	3/8	22	24
10	3/8	A105059/1021	9/16-18	1/2	22.5	29.5
12	1/2	A105059/1213	3/4-16	1/4	25	24
12	1/2	A105059/1217	3/4-16	3/8	25	24
12	1/2	A105059/1221	3/4-16	1/2	25.5	29.5
14÷16	5/8	A105059/1617	7/8-14	3/8	28	24.5
14÷16	5/8	A105059/1621	7/8-14	1/2	28	29.5
14÷16	5/8	A105059/1626	7/8-14	3/4	30	30.5
18-20	3/4	A105059/2021	1" 1/16-12	1/2	32.5	30.5
18-20	3/4	A105059/2026	1" 1/16-12	3/4	32.5	30.5
18-20	3/4	A105059/2033	1" 1/16-12	1"	36	37.5
22	7/8	A105059/2226	1" 3/16-12	3/4	35	32
25	1"	A105059/2526	1" 5/16-12	3/4	37	32.5
25	1"	A105059/2533	1" 5/16-12	1"	37	37.5
30-32	1" 1/4	A105059/3233	1" 5/8-12	1"	40.5	42
30-32	1" 1/4	A105059/3242	1" 5/8-12	1" 1/4	40.5	42.5
38	1" 1/2	A105059/3848	1" 7/8-12	1" 1/2	45	45
6	1/4	SA105059/0617	7/16-20	3/8	22.5	24
8	5/16	SA105059/0817	1/2-20	3/8	22	24
10	3/8	SA105059/1010	9/16-18	1/8	21	20.5

Terminale 45°
JIC cono 37° - GAS conico (BSPT)
per sedi ISO 7
45° elbow male
JIC - male BSPT taper ISO 7 ports
SEDI PAG.35 / PORTS PAG.35

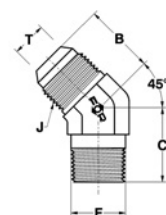

RACCORDI PER TUBI SVASATI - 37°

37° - FLARED TUBE CONNECTORS

106005

Giunzione 45° passaparatia
JIC cono 37° - JIC cono 37°
45° bulkhead elbow male
JIC - JIC

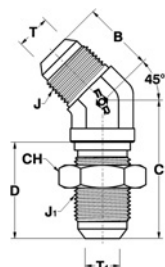

T		T ₁		RIFERIMENTO REFERENCE	J	J ₁	B	C	D	CH
MM.	IN.	MM.	IN.		UNF-UN	UNF-UN				
6	1/4	6	1/4	A106005/06	7/16-20	7/16-20	18	39	28,5	17
8	5/16	8	5/16	A106005/08	1/2-20	1/2-20	19.5	39	28,5	19
10	3/8	10	3/8	A106005/10	9/16-18	9/16-18	21	42.5	30	22
12	1/2	12	1/2	A106005/12	3/4-16	3/4-16	25	49	35	24
14÷16	5/8	14÷16	5/8	A106005/16	7/8-14	7/8-14	28	55	38,5	30
18-20	3/4	18-20	3/4	A106005/20	1" 1/16-12	1" 1/16-12	32.5	62	42,5	36
22	7/8	22	7/8	A106005/22	1" 3/16-12	1" 3/16-12	35	63.5	42,5	38
25	1"	25	1"	A106005/25	1" 5/16-12	1" 5/16-12	37	65	42,5	41
30-32	1" 1/4	30-32	1" 1/4	A106005/32	1" 5/8-12	1" 5/8-12	40.5	67	44	50
38	1" 1/2	38	1" 1/2	A106005/38	1" 7/8-12	1" 7/8-12	45	67.5	44	55

107006

Giunzione 90°
JIC cono 37° - JIC cono 37°
90° elbow male
JIC - JIC

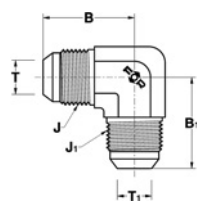

T		T ₁		RIFERIMENTO REFERENCE	J	J ₁	B	B ₁
MM.	IN.	MM.	IN.		UNF-UN	UNF-UN		
6	1/4	6	1/4	A107006/06	7/16-20	7/16-20	22.5	22.5
8	5/16	8	5/16	A107006/08	1/2-20	1/2-20	24	24
10	3/8	10	3/8	A107006/10	9/16-18	9/16-18	27	27
12	1/2	12	1/2	A107006/12	3/4-16	3/4-16	31.5	31.5
14÷16	5/8	14÷16	5/8	A107006/16	7/8-14	7/8-14	36.5	36.5
18-20	3/4	18-20	3/4	A107006/20	1" 1/16-12	1" 1/16-12	42	42
22	7/8	22	7/8	A107006/22	1" 3/16-12	1" 3/16-12	44	44
25	1"	25	1"	A107006/25	1" 5/16-12	1" 5/16-12	46	46
30-32	1" 1/4	30-32	1" 1/4	A107006/32	1" 5/8-12	1" 5/8-12	52	52
38	1" 1/2	38	1" 1/2	A107006/38	1" 7/8-12	1" 7/8-12	59	59
14÷16	5/8	12	1/2	SA107006/1612	7/8-14	3/4-16	36.5	33.5
14÷16	5/8	18-20	3/4	SA107006/1620	7/8-14	1" 1/16-12	39.5	42
18-20	3/4	12	1/2	SA107006/2012	1" 1/16-12	3/4-16	42	36.5
18-20	3/4	25	1"	SA107006/2025	1" 1/16-12	1" 5/16-12	45	46
22	7/8	18-20	3/4	SA107006/2220	1" 3/16-12	1" 1/16-12	44	43.5
30-32	1" 1/4	25	1"	SA107006/3225	1" 5/8-12	1" 5/16-12	52	50.5



T		RIFERIMENTO REFERENCE	J	J ₁	B	C	CH
MM.	IN.		UNF-UN	UNF-UN			
6	1/4	A107017/06	7/16-20	7/16-20	22,5	26	14
8	5/16	A107017/08	1/2-20	1/2-20	24	29,5	17
10	3/8	A107017/10	9/16-18	9/16-18	27	32	17
12	1/2	A107017/12	3/4-16	3/4-16	31,5	35,5	22
14÷16	5/8	A107017/16	7/8-14	7/8-14	36,5	42	27
18-20	3/4	A107017/20	1" 1/16-12	1" 1/16-12	42	45,5	32
22	7/8	A107017/22	1" 3/16-12	1" 3/16-12	44	46,5	36
25	1"	A107017/25	1" 5/16-12	1" 5/16-12	46	51,5	38
30-32	1" 1/4	A107017/32	1" 5/8-12	1" 5/8-12	52	59,5	50
38	1" 1/2	A107017/38	1" 7/8-12	1" 7/8-12	59	67	57
10	3/8	SA107017/1008	9/16-18	1/2-20	27	31	17
12	1/2	SA107017/1210	3/4-16	9/16-18	31,5	34	17
14÷16	5/8	SA107017/1612	7/8-14	3/4-16	36,5	39	22
14÷16	5/8	SA107017/1620	7/8-14	1" 1/16-12	39,5	45,5	32
18-20	3/4	SA107017/2012	1" 1/16-12	3/4-16	42	41	22
18-20	3/4	SA107017/2022	1" 1/16-12	1" 3/16-12	43,5	46,5	36
18-20	3/4	SA107017/2025	1" 1/16-12	1" 5/16-12	44,5	51,5	38
18-20	3/4	SA107017/2032	1" 1/16-12	1" 5/8-12	50	59,5	50
22	7/8	SA107017/2225	1" 3/16-12	1" 5/16-12	45,5	51,5	38
25	1"	SA107017/2532	1" 5/16-12	1" 5/8-12	50,5	59,5	50
30-32	1" 1/4	SA107017/3225	1" 5/8-12	1" 5/16-12	52	57	38
50	2"	SA107017/50	2" 1/2-12	2" 1/2-12	78	86	75

107017

Giunzione 90° maschio
JIC cono 37° - femmina
JIC cono 37°
90° elbow male
JIC - swivel female JIC

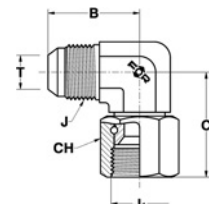

RACCORDI PER TUBI SVASATI - 37°

37° - FLARED TUBE CONNECTORS

107028

Terminale orientabile 90°
JIC cono 37° - SAE UNF-UN
per sedi ISO 11926
90° (ADJ) elbow male
JIC - male SAE UNF-UN
with O.R. ISO 11926 ports

SEDI PAG.30 / PORTS PAG.30

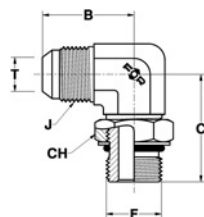

T		RIFERIMENTO REFERENCE	J	F	B	C	CH
MM.	IN.		UNF-UN	UNF-UN			
6	1/4	A107028/0611	7/16-20	7/16-20	22,5	27,5	14
6	1/4	A107028/0612	7/16-20	1/2-20	24	28	17
6	1/4	A107028/0614	7/16-20	9/16-18	27	31,5	17
8	5/16	A107028/0812	1/2-20	1/2-20	24	28	17
10	3/8	A107028/1014	9/16-18	9/16-18	27	31,5	17
10	3/8	A107028/1019	9/16-18	3/4-16	28,5	36,5	22
12	1/2	A107028/1219	3/4-16	3/4-16	31,5	36,5	22
12	1/2	A107028/1222	3/4-16	7/8-14	34	43	27
12	1/2	A107028/1227	3/4-16	1" 1/16-12	37	49	32
14÷16	5/8	A107028/1619	7/8-14	3/4-16	36,5	39,5	22
14÷16	5/8	A107028/1622	7/8-14	7/8-14	36,5	43	27
14÷16	5/8	A107028/1627	7/8-14	1" 1/16-12	39,5	49	32
18-20	3/4	A107028/2019	1" 1/16-12	3/4-16	42	42	22
18-20	3/4	A107028/2022	1" 1/16-12	7/8-14	42	45,5	27
18-20	3/4	A107028/2027	1" 1/16-12	1" 1/16-12	42	49	32
18-20	3/4	A107028/2033	1" 1/16-12	1" 5/16-12	44,5	52,5	38
22	7/8	A107028/2230	1" 3/16-12	1" 3/16-12	44	50,5	35
25	1"	A107028/2527	1" 5/16-12	1" 1/16-12	46	52,5	32
25	1"	A107028/2533	1" 5/16-12	1" 5/16-12	46	52,5	38
25	1"	A107028/2541	1" 5/16-12	1" 5/8-12	51	57	50
30-32	1" 1/4	A107028/3241	1" 5/8-12	1" 5/8-12	52	57	50
38	1" 1/2	A107028/3848	1" 7/8-12	1" 7/8-12	59	61	55
6	1/4	SA107028/0619	7/16-20	3/4-16	28	36,5	22
6	1/4	SA107028/0622	7/16-20	7/8-14	30,5	43	27
8	5/16	SA107028/0811	1/2-20	7/16-20	24	28	14
8	5/16	SA107028/0814	1/2-20	9/16-18	27	31,5	17
8	5/16	SA107028/0819	1/2-20	3/4-16	28,5	36,5	22
10	3/8	SA107028/1011	9/16-18	7/16-20	27	30	14
10	3/8	SA107028/1012	9/16-18	1/2-20	27	30	17
10	3/8	SA107028/1022	9/16-18	7/8-14	32	43	27
12	1/2	SA107028/1214	3/4-16	9/16-18	31,5	33,5	17
12	1/2	SA107028/1233	3/4-16	1" 5/16-12	39	52	38
14÷16	5/8	SA107028/1614	7/8-14	9/16-18	36,5	37	17
14÷16	5/8	SA107028/1630	7/8-14	1" 3/16-12	40	50,5	35
18-20	3/4	SA107028/2030	1" 1/16-12	1" 3/16-12	43	50,5	35
18-20	3/4	SA107028/2041	1" 1/16-12	1" 5/8-12	50	57	50
22	7/8	SA107028/2222	1" 3/16-12	7/8-14	44	46,5	27
22	7/8	SA107028/2227	1" 3/16-12	1" 1/16-12	45,5	50	32
22	7/8	SA107028/2233	1" 3/16-12	1" 5/16-12	45,5	52,5	38
25	1"	SA107028/2522	1" 5/16-12	7/8-14	46	48,5	27
25	1"	SA107028/2530	1" 5/16-12	1" 3/16-12	46	52	35
30-32	1" 1/4	SA107028/3233	1" 5/8-12	1" 5/16-12	52	57	38
30-32	1" 1/4	SA107028/3248	1" 5/8-12	1" 7/8-12	56	61,5	55
38	1" 1/2	SA107028/3841	1" 7/8-12	1" 5/8-12	59	61,5	50



107039

T		RIFERIMENTO REFERENCE	J	F	B	C	CH
MM.	IN.		UNF-UN	GAS CIL.BSPP			
6	1/4	A107039/0610	7/16-20	1/8	22.5	26.5	14
6	1/4	A107039/0613	7/16-20	1/4	27	31.5	19
6	1/4	A107039/0617	7/16-20	3/8	28.5	36.5	22
6	1/4	A107039/0621	7/16-20	1/2	31	43	27
8	5/16	A107039/0810	1/2-20	1/8	24	28	14
8	5/16	A107039/0813	1/2-20	1/4	27	31.5	19
8	5/16	A107039/0817	1/2-20	3/8	28.5	36.5	22
10	3/8	A107039/1013	9/16-18	1/4	27	31.5	19
10	3/8	A107039/1017	9/16-18	3/8	28.5	36.5	22
10	3/8	A107039/1021	9/16-18	1/2	31	43	27
12	1/2	A107039/1213	3/4-16	1/4	31.5	33.5	19
12	1/2	A107039/1217	3/4-16	3/8	31.5	36.5	22
12	1/2	A107039/1221	3/4-16	1/2	34	43	27
12	1/2	A107039/1226	3/4-16	3/4	37	49	36
14÷16	5/8	A107039/1617	7/8-14	3/8	36.5	39.5	22
14÷16	5/8	A107039/1621	7/8-14	1/2	36.5	43	27
14÷16	5/8	A107039/1626	7/8-14	3/4	39.5	49	36
18-20	3/4	A107039/2021	1" 1/16-12	1/2	42	45.5	27
18-20	3/4	A107039/2026	1" 1/16-12	3/4	42	49	36
18-20	3/4	A107039/2033	1" 1/16-12	1"	44.5	52.5	41
22	7/8	A107039/2226	1" 3/16-12	3/4	44	50.5	36
25	1"	A107039/2526	1" 5/16-12	3/4	46	52.5	36
25	1"	A107039/2533	1" 5/16-12	1"	46	52.5	41
25	1"	A107039/2542	1" 5/16-12	1" 1/4	51	57	50
30-32	1" 1/4	A107039/3233	1" 5/8-12	1"	52	57	41
30-32	1" 1/4	A107039/3242	1" 5/8-12	1" 1/4	52	57	50
38	1" 1/2	A107039/3842	1" 7/8-12	1" 1/4	59	61.5	50
38	1" 1/2	A107039/3848	1" 7/8-12	1" 1/2	59	61.5	60
8	5/16	SA107039/0821	1/2-20	1/2	28	43	27
10	3/8	SA107039/1010	9/16-18	1/8	27	30	14
12	1/2	SA107039/1233	3/4-16	1"	39.5	52.5	41
14÷16	5/8	SA107039/1613	7/8-14	1/4	36.5	30.5	19
14÷16	5/8	SA107039/1623	7/8-14	5/8	36.5	43	30
14÷16	5/8	SA107039/1633	7/8-14	1"	42	52.5	41
18-20	3/4	SA107039/2017	1" 1/16-12	3/8	42	42	22
18-20	3/4	SA107039/2023	1" 1/16-12	5/8	42	48.5	30
18-20	3/4	SA107039/2042	1" 1/16-12	1" 1/4	49	57	50
22	7/8	SA107039/2221	1" 3/16-12	1/2	44	46.5	27
22	7/8	SA107039/2233	1" 3/16-12	1"	46	52.5	41
25	1"	SA107039/2521	1" 5/16-12	1/2	46	48.5	27
25	1"	SA107039/2548	1" 5/16-12	1" 1/2	54.5	61.5	60
30-32	1" 1/4	SA107039/3226	1" 5/8-12	3/4	52	55.5	36
30-32	1" 1/4	SA107039/3248	1" 5/8-12	1" 1/2	56	61.5	60
38	1" 1/2	SA107039/3833	1" 7/8-12	1"	59	60.5	41

Terminale orientabile 90°
JIC cono 37° - GAS cil. (BSPP)
con O.R. e rondella
per sedi ISO 1179
90° (ADJ) elbow male
JIC - male BSPP
with O.R. and retaining ring
ISO 1179 ports
SEDI PAG.32 / PORTS PAG.32

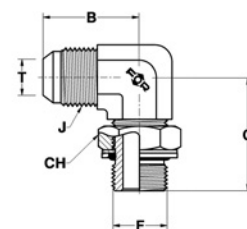

RACCORDI PER TUBI SVASATI - 37°

37° - FLARED TUBE CONNECTORS

107194

Terminale orientabile 90°
 JIC cono 37° - GAS cil. (JIS)
 con O.R. per sedi JIS 2351
 90° (ADJ) elbow male
 JIC - male JIS
 with O.R. JIS 2351 ports

SEDI PAG.31 / PORTS PAG.31

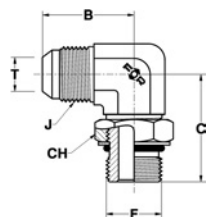

T		RIFERIMENTO REFERENCE	J	F	B	C	CH
MM.	IN.		UNF-UN	GAS CIL-JIS			
6	1/4	A107194/0610	7/16-20	1/8	22.5	26.5	14
6	1/4	A107194/0613	7/16-20	1/4	27	31.5	19
6	1/4	A107194/0617	7/16-20	3/8	28.5	36.5	22
6	1/4	A107194/0621	7/16-20	1/2	31	43	27
8	5/16	A107194/0810	1/2-20	1/8	24	28	14
8	5/16	A107194/0813	1/2-20	1/4	27	31.5	19
8	5/16	A107194/0817	1/2-20	3/8	28.5	36.5	22
8	5/16	A107194/0821	1/2-20	1/2	28	43	27
10	3/8	A107194/1010	9/16-18	1/8	27	30	14
10	3/8	A107194/1013	9/16-18	1/4	27	31.5	19
10	3/8	A107194/1017	9/16-18	3/8	28.5	36.5	22
10	3/8	A107194/1021	9/16-18	1/2	31	43	27
12	1/2	A107194/1213	3/4-16	1/4	31.5	33.5	19
12	1/2	A107194/1217	3/4-16	3/8	31.5	36.5	22
12	1/2	A107194/1221	3/4-16	1/2	34	43	27
12	1/2	A107194/1226	3/4-16	3/4	37	49	36
12	1/2	A107194/1233	3/4-16	1"	39.5	52.5	41
14÷16	5/8	A107194/1613	7/8-14	1/4	36.5	30.5	19
14÷16	5/8	A107194/1617	7/8-14	3/8	36.5	39.5	22
14÷16	5/8	A107194/1621	7/8-14	1/2	36.5	43	27
14÷16	5/8	A107194/1626	7/8-14	3/4	39.5	49	36
14÷16	5/8	A107194/1633	7/8-14	1"	42	52.5	41
18-20	3/4	A107194/2017	1" 1/16-12	3/8	42	42	22
18-20	3/4	A107194/2021	1" 1/16-12	1/2	42	45.5	27
18-20	3/4	A107194/2026	1" 1/16-12	3/4	42	49	36
18-20	3/4	A107194/2033	1" 1/16-12	1"	44.5	52.5	41
18-20	3/4	A107194/2042	1" 1/16-12	1" 1/4	49	57	50
22	7/8	A107194/2221	1" 3/16-12	1/2	44	46.5	27
22	7/8	A107194/2226	1" 3/16-12	3/4	44	50.5	36
22	7/8	A107194/2233	1" 3/16-12	1"	46	52.5	41
25	1"	A107194/2521	1" 5/16-12	1/2	46	48.5	27
25	1"	A107194/2526	1" 5/16-12	3/4	46	52.5	36
25	1"	A107194/2533	1" 5/16-12	1"	46	52.5	41
25	1"	A107194/2542	1" 5/16-12	1" 1/4	51	57	50
25	1"	A107194/2548	1" 5/16-12	1" 1/2	54.5	61.5	55
30-32	1" 1/4	A107194/3226	1" 5/8-12	3/4	52	55.5	36
30-32	1" 1/4	A107194/3233	1" 5/8-12	1"	52	57	41
30-32	1" 1/4	A107194/3242	1" 5/8-12	1" 1/4	52	57	50
30-32	1" 1/4	A107194/3248	1" 5/8-12	1" 1/2	56	61.5	55
38	1" 1/2	A107194/3833	1" 7/8-12	1"	59	60.5	41
38	1" 1/2	A107194/3842	1" 7/8-12	1" 1/4	59	61.5	50
38	1" 1/2	A107194/3848	1" 7/8-12	1" 1/2	59	61.5	55



107183

T		RIFERIMENTO REFERENCE	J	F	B	C	CH	CH ₁
MM.	IN.		UNF-UN	GAS CIL.BSPP				
6	1/4	A107183/0610	7/16-20	1/8	31	26,5	14	14
6	1/4	A107183/0613	7/16-20	1/4	31	31,5	14	19
8	5/16	A107183/0813	1/2-20	1/4	33	31,5	17	19
8	5/16	A107183/0817	1/2-20	3/8	33,5	36,5	17	22
10	3/8	A107183/1013	9/16-18	1/4	32	31,5	17	19
10	3/8	A107183/1017	9/16-18	3/8	34,5	36,5	17	22
12	1/2	A107183/1213	3/4-16	1/4	35,5	33,5	22	19
12	1/2	A107183/1217	3/4-16	3/8	35,5	36,5	22	22
12	1/2	A107183/1221	3/4-16	1/2	41	43	22	27
14÷16	5/8	A107183/1621	7/8-14	1/2	44	43	27	27
14÷16	5/8	A107183/1626	7/8-14	3/4	43	49	27	36
18-20	3/4	A107183/2021	1" 1/16-12	1/2	47,5	46	32	27
18-20	3/4	A107183/2026	1" 1/16-12	3/4	47,5	49	32	36
25	1"	A107183/2533	1" 5/16-12	1"	53	52,5	38	41
25	1"	A107183/2542	1" 5/16-12	1" 1/4	58	57	38	50
30-32	1" 1/4	A107183/3233	1" 5/8-12	1"	60	57	50	41
30-32	1" 1/4	A107183/3242	1" 5/8-12	1" 1/4	60	60	50	50
38	1" 1/2	A107183/3848	1" 7/8-12	1" 1/4	69	61,5	57	60

Terminale orientabile 90°
femmina JIC cono 37°-
GAS cil. (BSPP)
con O.R. e rondella
per sedi ISO 1179
90° (AD) elbow
swivel female JIC - male BSPP
with O.R. and retaining ring
ISO 1179 ports

SEDI PAG.32 / PORTS PAG.32

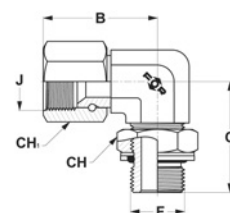

RACCORDI PER TUBI SVASATI - 37°

37° - FLARED TUBE CONNECTORS

107040

Terminale orientabile 90°
JIC cono 37° - Metrico cil.
con O.R. e rondella
per sedi ISO 9974
90° (AD) elbow male
JIC - male Metric
with O.R. and retaining ring
ISO 9974 ports

SEDI PAG.32 / PORTS PAG.32

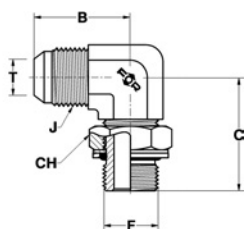

T		RIFERIMENTO REFERENCE	J	F	B	C	CH
MM.	IN.		UNF-UN	METRICO METRIC			
6	1/4	A107040/0610	7/16-20	10x1	22,5	27,5	14
6	1/4	A107040/0612	7/16-20	12x1,5	27	31,5	17
8	5/16	A107040/0810	1/2-20	10x1	24	28	14
8	5/16	A107040/0812	1/2-20	12x1,5	27	31,5	17
8	5/16	A107040/0814	1/2-20	14x1,5	27	32,5	19
10	3/8	A107040/1014	9/16-18	14x1,5	27	32,5	19
10	3/8	A107040/1016	9/16-18	16x1,5	28,5	36,5	22
12	1/2	A107040/1216	3/4-16	16x1,5	31,5	36,5	22
12	1/2	A107040/1218	3/4-16	18x1,5	31,5	39,5	24
14÷16	5/8	A107040/1618	7/8-14	18x1,5	36,5	41,5	24
14÷16	5/8	A107040/1620	7/8-14	20x1,5	36,5	43	27
14÷16	5/8	A107040/1622	7/8-14	22x1,5	36,5	43	27
18-20	3/4	A107040/2022	1" 1/16-12	22x1,5	42	45,5	27
18-20	3/4	A107040/2027	1" 1/16-12	27x2	42	51,5	32
22	7/8	A107040/2226	1" 3/16-12	26x1,5	44	50,5	36
25	1"	A107040/2527	1" 5/16-12	27x2	46	55	32
25	1"	A107040/2533	1" 5/16-12	33x2	46	55	41
30-32	1" 1/4	A107040/3242	1" 5/8-12	42x2	52	60	50
38	1" 1/2	A107040/3848	1" 7/8-12	48x2	59	67	55
6	1/4	SA107040/0614	7/16-20	14x1,5	27	32,5	19
6	1/4	SA107040/0618	7/16-20	18x1,5	29	39,5	24
8	5/16	SA107040/0816	1/2-20	16x1,5	28,5	36,5	22
8	5/16	SA107040/0818	1/2-20	18x1,5	29	39,5	24
10	3/8	SA107040/1010	9/16-18	10x1	27	29,5	14
10	3/8	SA107040/1012	9/16-18	12x1,5	27	32,5	17
10	3/8	SA107040/1018	9/16-18	18x1,5	29	39,5	24
10	3/8	SA107040/1020	9/16-18	20x1,5	31,5	43	27
10	3/8	SA107040/1022	9/16-18	22x1,5	31,5	43	27
12	1/2	SA107040/1212	3/4-16	12x1,5	31,5	35	17
12	1/2	SA107040/1214	3/4-16	14x1,5	31,5	35,5	19
12	1/2	SA107040/1220	3/4-16	20x1,5	34	43	27
12	1/2	SA107040/1222	3/4-16	22x1,5	34	43	27
12	1/2	SA107040/1227	3/4-16	27x2	37	51,5	32
14÷16	5/8	SA107040/1612	7/8-14	12x1,5	36,5	38	17
14÷16	5/8	SA107040/1614	7/8-14	14x1,5	36,5	38	19
14÷16	5/8	SA107040/1616	7/8-14	16x1,5	37	38,5	22
14÷16	5/8	SA107040/1626	7/8-14	26x1,5	38,5	50,5	36
14÷16	5/8	SA107040/1627	7/8-14	27x2	39,5	51,5	32
18-20	3/4	SA107040/2018	1" 1/16-12	18x1,5	42	45	24
18-20	3/4	SA107040/2026	1" 1/16-12	26x1,5	42	50,5	36
18-20	3/4	SA107040/2030	1" 1/16-12	30x1,5	44	50,5	38
18-20	3/4	SA107040/2033	1" 1/16-12	33x2	45	55	41
18-20	3/4	SA107040/2042	1" 1/16-12	42x2	49,5	60	50
22	7/8	SA107040/2222	1" 3/16-12	22x1,5	44	48	27
25	1"	SA107040/2526	1" 5/16-12	26x1,5	46	52,5	36
25	1"	SA107040/2530	1" 5/16-12	30x1,5	46	54	38
25	1"	SA107040/2542	1" 5/16-12	42x2	50,5	60	50
30-32	1" 1/4	SA107040/3233	1" 5/8-12	33x2	52	59	41

FOR S.P.A. - NORME E DIMENSIONI SOGGETTE A MODIFICHE SENZA PREAVVISO.
FOR S.P.A. - DESIGN DETAILS AND SPECIFICATIONS SUBJECT TO CHANGE WITHOUT PRIOR NOTICE.



107161

T		RIFERIMENTO REFERENCE	J	F	B	C	CH
MM.	IN.		UNF-UN	METRICO METRIC			
6	1/4	A107161/0610	7/16-20	10x1	22,5	27,5	14
6	1/4	A107161/0612	7/16-20	12x1,5	27	31,5	17
8	5/16	A107161/0810	1/2-20	10x1	24	28	14
8	5/16	A107161/0812	1/2-20	12x1,5	27	31,5	17
8	5/16	A107161/0814	1/2-20	14x1,5	27	32,5	19
10	3/8	A107161/1014	9/16-18	14x1,5	27	32,5	19
10	3/8	A107161/1016	9/16-18	16x1,5	28,5	36,5	22
12	1/2	A107161/1216	3/4-16	16x1,5	31,5	36,5	22
12	1/2	A107161/1218	3/4-16	18x1,5	31,5	39,5	24
14÷16	5/8	A107161/1618	7/8-14	18x1,5	36,5	41,5	24
14÷16	5/8	A107161/1622	7/8-14	22x1,5	36,5	43	27
18-20	3/4	A107161/2022	1" 1/16-12	22x1,5	42	45,5	27
18-20	3/4	A107161/2027	1" 1/16-12	27x2	42	51,5	32
25	1"	A107161/2527	1" 5/16-12	27x2	46	55	32
25	1"	A107161/2533	1" 5/16-12	33x2	46	55	41
30-32	1" 1/4	A107161/3242	1" 5/8-12	42x2	52	60	50
38	1" 1/2	A107161/3848	1" 7/8-12	48x2	59	67	55
6	1/4	SA107161/0614	7/16-20	14x1,5	27	32,5	19
12	1/2	SA107161/1214	3/4-16	14x1,5	31,5	35,5	19
12	1/2	SA107161/1220	3/4-16	20x1,5	34	43	27
12	1/2	SA107161/1222	3/4-16	22x1,5	34	43	27
18-20	3/4	SA107161/2018	1" 1/16-12	18x1,5	42	45	24

Terminale orientabile 90°
 JIC cono 37° - Metrico cil.
 con O.R. per sedi ISO 6149
 90° (AD) elbow male
 JIC - male Metric
 with O.R. ISO 6149 ports
 SEDI PAG.30 / PORTS PAG.30

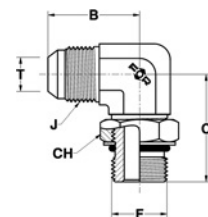

RACCORDI PER TUBI SVASATI - 37°

37° - FLARED TUBE CONNECTORS

107051

Terminale 90°
JIC cono 37° - NPTF
per sedi SAE 476
90° elbow male
JIC - male NPTF
taper SAE 476 ports

SEDI PAG.35 / PORTS PAG.35

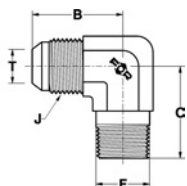

T		RIFERIMENTO REFERENCE	J	F	B	C
MM.	IN.		UNF-UN	NPTF		
6	1/4	A107051/0610	7/16-20	1/8	22.5	19.5
6	1/4	A107051/0613	7/16-20	1/4	27	27.5
8	5/16	A107051/0810	1/2-20	1/8	24	19.5
8	5/16	A107051/0813	1/2-20	1/4	27	27.5
10	3/8	A107051/1010	9/16-18	1/8	27	23.5
10	3/8	A107051/1013	9/16-18	1/4	27	27.5
10	3/8	A107051/1017	9/16-18	3/8	28.5	31
10	3/8	A107051/1021	9/16-18	1/2	31	37
12	1/2	A107051/1213	3/4-16	1/4	31.5	31
12	1/2	A107051/1217	3/4-16	3/8	31.5	31
12	1/2	A107051/1221	3/4-16	1/2	34	37
12	1/2	A107051/1226	3/4-16	3/4	37	40.5
14÷16	5/8	A107051/1617	7/8-14	3/8	36.5	32
14÷16	5/8	A107051/1621	7/8-14	1/2	36.5	37
14÷16	5/8	A107051/1626	7/8-14	3/4	39.5	40.5
18-20	3/4	A107051/2021	1" 1/16-12	1/2	42	40.5
18-20	3/4	A107051/2026	1" 1/16-12	3/4	42	40.5
22	7/8	A107051/2226	1" 3/16-12	3/4	44	43
25	1"	A107051/2526	1" 5/16-12	3/4	46	45
25	1"	A107051/2533	1" 5/16-12	1"	46	50
30-32	1" 1/4	A107051/3233	1" 5/8-12	1"	52	59
30-32	1" 1/4	A107051/3242	1" 5/8-12	1" 1/4	52	60
38	1" 1/2	A107051/3848	1" 7/8-12	1" 1/2	59	67
3	1/8	SA107051/0310	5/16-24	1/8	22.5	19.5
4	3/16	SA107051/0410	3/8-24	1/8	22.5	19.5
6	1/4	SA107051/0617	7/16-20	3/8	29	31
8	5/16	SA107051/0817	1/2-20	3/8	28.5	31
10	3/8	SA107051/1026	9/16-18	3/4	34.5	40.5
12	1/2	SA107051/1233	3/4-16	1"	39.5	50
18-20	3/4	SA107051/2017	1" 1/16-12	3/8	42	36
18-20	3/4	SA107051/2033	1" 1/16-12	1"	44.5	50
25	1"	SA107051/2542	1" 5/16-12	1" 1/4	50.5	60
25	1"	SA107051/2548	1" 5/16-12	1" 1/2	54.5	67
30-32	1" 1/4	SA107051/3248	1" 5/8-12	1" 1/2	56	67
38	1" 1/2	SA107051/3842	1" 7/8-12	1" 1/4	59	63
50	2"	SA107051/5048	2" 1/2-12	1" 1/2	77.5	75.5
50	2"	SA107051/5060	2" 1/2-12	2"	77.5	76



107062

T		RIFERIMENTO REFERENCE	J	F	B	C
MM.	IN.		UNF-UN	GAS CON.BSPT		
6	1/4	A107062/0610	7/16-20	1/8	22,5	20,5
6	1/4	A107062/0613	7/16-20	1/4	27	27,5
8	5/16	A107062/0810	1/2-20	1/8	24	19,5
8	5/16	A107062/0813	1/2-20	1/4	27	27,5
10	3/8	A107062/1013	9/16-18	1/4	27	27,5
10	3/8	A107062/1017	9/16-18	3/8	28,5	31
10	3/8	A107062/1021	9/16-18	1/2	31	37
12	1/2	A107062/1213	3/4-16	1/4	31,5	31
12	1/2	A107062/1217	3/4-16	3/8	31,5	31
12	1/2	A107062/1221	3/4-16	1/2	34	37
14÷16	5/8	A107062/1617	7/8-14	3/8	36,5	32
14÷16	5/8	A107062/1621	7/8-14	1/2	36,5	37
14÷16	5/8	A107062/1626	7/8-14	3/4	39,5	40,5
18-20	3/4	A107062/2021	1" 1/16-12	1/2	42	40,5
18-20	3/4	A107062/2026	1" 1/16-12	3/4	42	40,5
18-20	3/4	A107062/2033	1" 1/16-12	1"	45	50
22	7/8	A107062/2226	1" 3/16-12	3/4	44	43
25	1"	A107062/2526	1" 5/16-12	3/4	46	44,5
25	1"	A107062/2533	1" 5/16-12	1"	46	50
30-32	1" 1/4	A107062/3233	1" 5/8-12	1"	52	59
30-32	1" 1/4	A107062/3242	1" 5/8-12	1" 1/4	52	60
38	1" 1/2	A107062/3848	1" 7/8-12	1" 1/2	59	67
6	1/4	SA107062/0617	7/16-20	3/8	28,5	31
8	5/16	SA107062/0817	1/2-20	3/8	28,5	31
10	3/8	SA107062/1010	9/16-18	1/8	27,5	24,5
12	1/2	SA107062/1210	3/4-16	1/8	31,5	27
12	1/2	SA107062/1226	3/4-16	3/4	37	40,5
18-20	3/4	SA107062/2042	1" 1/16-12	1" 1/4	49	60
25	1"	SA107062/2542	1" 5/16-12	1" 1/4	50,5	60
30-32	1" 1/4	SA107062/3248	1" 5/8-12	1" 1/2	56	67
38	1" 1/2	SA107062/3842	1" 7/8-12	1" 1/4	59	63

Terminale 90°
JIC cono 37° - GAS conico (BSPT)
per sedi ISO 7
90° elbow male
JIC - male BSPT
taper ISO 7 ports

SEDI PAG.35 / PORTS PAG.35

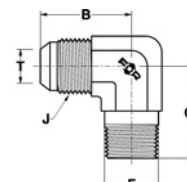

RACCORDI PER TUBI SVASATI - 37°

37° - FLARED TUBE CONNECTORS

107084

Giunzione 90°
JIC cono 37° - femmina NPTF
90° elbow male
JIC - female NPTF

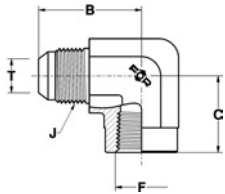

T		RIFERIMENTO REFERENCE	J	F	B	C
MM.	IN.		UNF-UN	NPTF		
6	1/4	A107084/0610	7/16-20	1/8	27	16.5
6	1/4	A107084/0613	7/16-20	1/4	31	22.5
8	5/16	A107084/0810	1/2-20	1/8	27	16.5
8	5/16	A107084/0813	1/2-20	1/4	31	22.5
10	3/8	A107084/1010	9/16-18	1/8	27	16.5
10	3/8	A107084/1013	9/16-18	1/4	31	22.5
10	3/8	A107084/1017	9/16-18	3/8	33	26
12	1/2	A107084/1213	3/4-16	1/4	32	22.5
12	1/2	A107084/1217	3/4-16	3/8	36	26
12	1/2	A107084/1221	3/4-16	1/2	39	31
14÷16	5/8	A107084/1621	7/8-14	1/2	41.5	31
18-20	3/4	A107084/2021	1" 1/16-12	1/2	42	31
18-20	3/4	A107084/2026	1" 1/16-12	3/4	47	34.5
22	7/8	A107084/2226	1" 3/16-12	3/4	47	36
25	1"	A107084/2533	1" 5/16-12	1"	55	41
30-32	1" 1/4	A107084/3242	1" 5/8-12	1" 1/4	59	43
38	1" 1/2	A107084/3848	1" 7/8-12	1" 1/2	73,5	52,5
8	5/16	SA107084/0821	1/2-20	1/2	36,5	31

107095

Giunzione 90°
JIC cono 37° - femmina
Gas cil. (BSPP)
90° elbow male
JIC - female BSPP

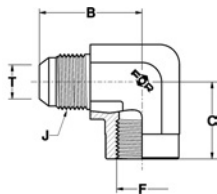

T		RIFERIMENTO REFERENCE	J	F	B	C
MM.	IN.		UNF-UN	GAS CIL.-JIS		
6	1/4	A107095/0610	7/16-20	1/8	27	16.5
6	1/4	A107095/0613	7/16-20	1/4	31	22.5
6	1/4	A107095/0617	7/16-20	3/8	33	26
8	5/16	A107095/0810	1/2-20	1/8	27	16.5
8	5/16	A107095/0813	1/2-20	1/4	31	22.5
10	3/8	A107095/1013	9/16-18	1/4	31	22.5
10	3/8	A107095/1017	9/16-18	3/8	33	26
10	3/8	A107095/1021	9/16-18	1/2	36	31
12	1/2	A107095/1213	3/4-16	1/4	32	22.5
12	1/2	A107095/1217	3/4-16	3/8	36	26
12	1/2	A107095/1221	3/4-16	1/2	39	31
14÷16	5/8	A107095/1621	7/8-14	1/2	41.5	31
18-20	3/4	A107095/2021	1" 1/16-12	1/2	42	31
18-20	3/4	A107095/2026	1" 1/16-12	3/4	47	34.5
22	7/8	A107095/2226	1" 3/16-12	3/4	47	36
25	1"	A107095/2533	1" 5/16-12	1"	55	41
30-32	1" 1/4	A107095/3233	1" 5/8-12	1"	55	41
30-32	1" 1/4	A107095/3242	1" 5/8-12	1" 1/4	59	43
38	1" 1/2	A107095/3842	1" 7/8-12	1" 1/4	59	43
38	1" 1/2	A107095/3848	1" 7/8-12	1" 1/4	73,5	52,5
14÷16	5/8	SA107095/1626	7/8-14	3/4	44,5	34,5



T		RIFERIMENTO REFERENCE	J	B	C	T₁
MM.	IN.		<small>UNF-UN</small>			
6	1/4	A107116/0606	7/16-20	22.5	10.5	6
8	5/16	A107116/0808	1/2-20	24	13	8
8	5/16	A107116/0810	1/2-20	27	16	10
10	3/8	A107116/1010	9/16-18	27	16	10
10	3/8	A107116/1012	9/16-18	29	18	12
12	1/2	A107116/1212	3/4-16	31.5	18	12
12	1/2	A107116/1216	3/4-16	34	20	16
14÷16	5/8	A107116/1614	7/8-14	36.5	20	14
14÷16	5/8	A107116/1616	7/8-14	36.5	20	16
14÷16	5/8	A107116/1618	7/8-14	40	23	18
14÷16	5/8	A107116/1622	7/8-14	40	23	22
18-20	3/4	A107116/2018	1" 1/16-12	42	23	18
18-20	3/4	A107116/2020	1" 1/16-12	42	23	20
18-20	3/4	A107116/2025	1" 1/16-12	46	26	25
18-20	3/4	A107116/2027	1" 1/16-12	46	26	27
22	7/8	A107116/2222	1" 3/16-12	44	26	22
25	1"	A107116/2525	1" 5/16-12	46	26	25
25	1"	A107116/2527	1" 5/16-12	46	26	27
25	1"	A107116/2532	1" 5/16-12	51	33	32
25	1"	A107116/2534	1" 5/16-12	51	33	34
30-32	1" 1/4	A107116/3230	1" 5/8-12	52	33	30
30-32	1" 1/4	A107116/3232	1" 5/8-12	52	33	32
30-32	1" 1/4	A107116/3238	1" 5/8-12	56	35	38
38	1" 1/2	A107116/3838	1" 7/8-12	59	35	38
10	3/8	SA107116/1014	9/16-18	29	18	14
12	1/2	SA107116/1210	3/4-16	31,5	18	10
12	1/2	SA107116/1215	3/4-16	34	20	15
14÷16	5/8	SA107116/1620	7/8-14	40	23	20

107116

Giunzione 90° maschio
JIC cono 37° - sede a saldare
90° elbow male
JIC - braze female

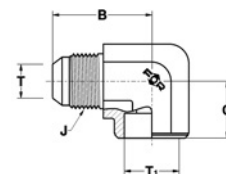

T		RIFERIMENTO REFERENCE	J	B	C	E
MM.	IN.		<small>UNF-UN</small>			
6	1/4	A107127/0619	7/16-20	31	22.5	15
8	5/16	A107127/0819	1/2-20	31	22.5	15
10	3/8	A107127/1019	9/16-18	31	22.5	15
12	1/2	A107127/1222	3/4-16	36	26	20
14÷16	5/8	A107127/1627	7/8-14	41.5	31	23
18-20	3/4	A107127/2034	1" 1/16-12	48	34.5	28
22	7/8	A107127/2234	1" 3/16-12	48	36	34
25	1"	A107127/2541	1" 5/16-12	55	41	35
30-32	1" 1/4	A107127/3248	1" 5/8-12	59	43	42
38	1" 1/2	A107127/3865	1" 7/8-12	73.5	53	50

107127

Giunzione 90° maschio
JIC cono 37° - codolo a saldare
90° elbow male
JIC - butt weld

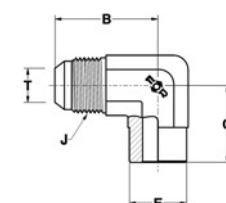

RACCORDI PER TUBI SVASATI - 37°

37° - FLARED TUBE CONNECTORS

108007

Giunzione 90° passaparatia
JIC cono 37° - JIC cono 37°
90° bulkhead elbow
male JIC - JIC

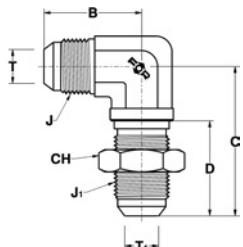

T		T ₁		RIFERIMENTO REFERENCE	J	J ₁	B	C	D	CH
MM.	IN.	MM.	IN.		UNF-UN	UNF-UN				
6	1/4	6	1/4	A108007/06	7/16-20	7/16-20	24.5	40.5	28.5	17
8	5/16	8	5/16	A108007/08	1/2-20	1/2-20	26	41	28.5	19
10	3/8	10	3/8	A108007/10	9/16-18	9/16-18	27.5	46	30	22
12	1/2	12	1/2	A108007/12	3/4-16	3/4-16	34.5	53.5	35	24
14÷16	5/8	14÷16	5/8	A108007/16	7/8-14	7/8-14	39.5	60.5	38.5	30
18-20	3/4	18-20	3/4	A108007/20	1" 1/16-12	1" 1/16-12	45	68	42.5	36
22	7/8	22	7/8	A108007/22	1" 3/16-12	1" 3/16-12	47	69	42.5	38
25	1"	25	1"	A108007/25	1" 5/16-12	1" 5/16-12	49	71	42.5	41
30-32	1" 1/4	30-32	1" 1/4	A108007/32	1" 5/8-12	1" 5/8-12	55	79	44	50
38	1" 1/2	38	1" 1/2	A108007/38	1" 7/8-12	1" 7/8-12	59	87	44	55

109008

Terminale lungo 90°
JIC cono 37° - NPTF
per sedi SAE 476
90° long elbow male
JIC - male NPTF
taper SAE 476 ports
SEDI PAG.35 / PORTS PAG.35

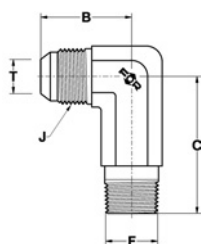

T		RIFERIMENTO REFERENCE	J	F	B	C
MM.	IN.		UNF-UN	NPTF		
6	1/4	A109008/0610	7/16-20	1/8	22.5	29.5
6	1/4	A109008/0613	7/16-20	1/4	27	40
8	5/16	A109008/0810	1/2-20	1/8	24	30.5
8	5/16	A109008/0813	1/2-20	1/4	27	40
10	3/8	A109008/1010	9/16-18	1/8	27	36
10	3/8	A109008/1013	9/16-18	1/4	27	40
10	3/8	A109008/1017	9/16-18	3/8	28.5	46
10	3/8	A109008/1021	9/16-18	1/2	31	55
12	1/2	A109008/1213	3/4-16	1/4	31.5	46
12	1/2	A109008/1217	3/4-16	3/8	31.5	46
12	1/2	A109008/1221	3/4-16	1/2	34	55
12	1/2	A109008/1226	3/4-16	3/4	37	62
14÷16	5/8	A109008/1617	7/8-14	3/8	36.5	50
14÷16	5/8	A109008/1621	7/8-14	1/2	36.5	55
14÷16	5/8	A109008/1626	7/8-14	3/4	39.5	62
18-20	3/4	A109008/2021	1" 1/16-12	1/2	42	62
18-20	3/4	A109008/2026	1" 1/16-12	3/4	42	62
22	7/8	A109008/2226	1" 3/16-12	3/4	44	67
25	1"	A109008/2526	1" 5/16-12	3/4	46	71.5
25	1"	A109008/2533	1" 5/16-12	1"	46	76.5
30-32	1" 1/4	A109008/3233	1" 5/8-12	1"	52	93
30-32	1" 1/4	A109008/3242	1" 5/8-12	1" 1/4	52	93
38	1" 1/2	A109008/3848	1" 7/8-12	1" 1/2	59	104



110000

T		RIFERIMENTO REFERENCE	J	F	B	C	CH
MM.	IN.		UNF-UN	UNF-UN			
6	1/4	A110000/0611	7/16-20	7/16-20	22,5	46	14
6	1/4	A110000/0612	7/16-20	1/2-20	24	49.5	17
6	1/4	A110000/0614	7/16-20	9/16-18	27	56.5	17
8	5/16	A110000/0812	1/2-20	1/2-20	24	49.5	17
10	3/8	A110000/1014	9/16-18	9/16-18	27	56.5	17
10	3/8	A110000/1019	9/16-18	3/4-16	28.5	67	22
12	1/2	A110000/1219	3/4-16	3/4-16	31.5	67	22
12	1/2	A110000/1222	3/4-16	7/8-14	34	78	27
12	1/2	A110000/1227	3/4-16	1" 1/16-12	37	92	32
14÷16	5/8	A110000/1619	7/8-14	3/4-16	36.5	75	22
14÷16	5/8	A110000/1622	7/8-14	7/8-14	36.5	78	27
14÷16	5/8	A110000/1627	7/8-14	1" 1/16-12	39.5	92	32
18-20	3/4	A110000/2019	1" 1/16-12	3/4-16	42	85	22
18-20	3/4	A110000/2022	1" 1/16-12	7/8-14	42	88	27
18-20	3/4	A110000/2027	1" 1/16-12	1" 1/16-12	42	92	32
18-20	3/4	A110000/2033	1" 1/16-12	1" 5/16-12	44.5	105	38
22	7/8	A110000/2230	1" 3/16-12	1" 3/16-12	44	99	35
25	1"	A110000/2527	1" 5/16-12	1" 1/16-12	46	105	32
25	1"	A110000/2533	1" 5/16-12	1" 5/16-12	46	105	38
25	1"	A110000/2541	1" 5/16-12	1" 5/8-12	51	124	50
30-32	1" 1/4	A110000/3241	1" 5/8-12	1" 5/8-12	52	124	50
38	1" 1/2	A110000/3848	1" 7/8-12	1" 7/8-12	59	134	55
12	1/2	SA110000/1214	3/4-16	9/16-18	31.5	64	17
30-32	1" 1/4	SA110000/3248	1" 5/8-12	1" 7/8-12	56	135	55

Prolunga orientabile 90°
JIC cono 37° - SAE UNF-UN
per sedi ISO 11926
90° (AD) long elbow male
JIC - male SAE UNF-UN
with O.R. ISO 11926 ports
SEDI PAG.30 / PORTS PAG.30

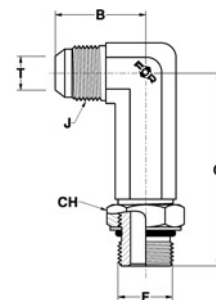

RACCORDI PER TUBI SVASATI - 37°

37° - FLARED TUBE CONNECTORS

110011

Prolunga orientabile 90°
 JIC cono 37° - GAS cil. (BSPP)
 con O.R. e rondella
 per sedi ISO 1179
 90° (AD) long elbow male
 JIC - male BSPP
 with O.R. and retaining ring
 ISO 1179 ports

SEDI PAG.32 / PORTS PAG.32

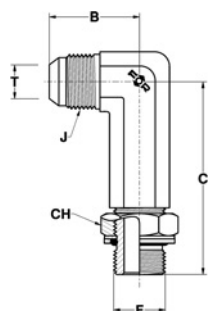

T		RIFERIMENTO REFERENCE	J	F	B	C	CH
MM.	IN.		UNF-UN	GAS CIL-BSPP			
6	1/4	A110011/0610	7/16-20	1/8	22,5	46	14
6	1/4	A110011/0613	7/16-20	1/4	27	56,5	19
6	1/4	A110011/0617	7/16-20	3/8	28,5	67	22
6	1/4	A110011/0621	7/16-20	1/2	31	78	27
8	5/16	A110011/0810	1/2-20	1/8	24	49,5	14
8	5/16	A110011/0813	1/2-20	1/4	27	56,5	19
8	5/16	A110011/0817	1/2-20	3/8	28,5	67	22
10	3/8	A110011/1013	9/16-18	1/4	27	56,5	19
10	3/8	A110011/1017	9/16-18	3/8	28,5	67	22
10	3/8	A110011/1021	9/16-18	1/2	31	78	27
12	1/2	A110011/1213	3/4-16	1/4	31,5	64	19
12	1/2	A110011/1217	3/4-16	3/8	31,5	67	22
12	1/2	A110011/1221	3/4-16	1/2	34	78	27
12	1/2	A110011/1226	3/4-16	3/4	37	92	36
14÷16	5/8	A110011/1617	7/8-14	3/8	36,5	75	22
14÷16	5/8	A110011/1621	7/8-14	1/2	36,5	78	27
14÷16	5/8	A110011/1626	7/8-14	3/4	39,5	92	36
18-20	3/4	A110011/2021	1" 1/16-12	1/2	42	88	27
18-20	3/4	A110011/2026	1" 1/16-12	3/4	42	92	36
18-20	3/4	A110011/2033	1" 1/16-12	1"	44,5	105	41
22	7/8	A110011/2226	1" 3/16-12	3/4	44	99	36
25	1"	A110011/2526	1" 5/16-12	3/4	46	105	36
25	1"	A110011/2533	1" 5/16-12	1"	46	105	41
25	1"	A110011/2542	1" 5/16-12	1" 1/4	51	124	50
30-32	1" 1/4	A110011/3233	1" 5/8-12	1"	52	124	41
30-32	1" 1/4	A110011/3242	1" 5/8-12	1" 1/4	52	124	50
38	1" 1/2	A110011/3842	1" 7/8-12	1" 1/4	59	134	50
38	1" 1/2	A110011/3848	1" 7/8-12	1" 1/2	59	134	60
14÷16	5/8	SA110011/1613	7/8-14	1/4	36,5	72,5	19



110088

T		RIFERIMENTO REFERENCE	J	F	B	C	CH
MM.	IN.		UNF-UN	GAS CIL-JIS			
6	1/4	A110088/0610	7/16-20	1/8	22,5	46	14
6	1/4	A110088/0613	7/16-20	1/4	27	56.5	19
6	1/4	A110088/0617	7/16-20	3/8	28.5	67	22
6	1/4	A110088/0621	7/16-20	1/2	31	78	27
8	5/16	A110088/0810	1/2-20	1/8	24	49.5	14
8	5/16	A110088/0813	1/2-20	1/4	27	56.5	19
8	5/16	A110088/0817	1/2-20	3/8	28.5	67	22
10	3/8	A110088/1013	9/16-18	1/4	27	56.5	19
10	3/8	A110088/1017	9/16-18	3/8	28.5	67	22
10	3/8	A110088/1021	9/16-18	1/2	31	78	27
12	1/2	A110088/1213	3/4-16	1/4	31.5	64	19
12	1/2	A110088/1217	3/4-16	3/8	31.5	67	22
12	1/2	A110088/1221	3/4-16	1/2	34	78	27
12	1/2	A110088/1226	3/4-16	3/4	37	92	36
14÷16	5/8	A110088/1613	7/8-14	1/4	36.5	72.5	19
14÷16	5/8	A110088/1617	7/8-14	3/8	36.5	75	22
14÷16	5/8	A110088/1621	7/8-14	1/2	36.5	78	27
14÷16	5/8	A110088/1626	7/8-14	3/4	39.5	92	36
18-20	3/4	A110088/2021	1" 1/16-12	1/2	42	88	27
18-20	3/4	A110088/2026	1" 1/16-12	3/4	42	92	36
18-20	3/4	A110088/2033	1" 1/16-12	1"	44.5	105	41
22	7/8	A110088/2226	1" 3/16-12	3/4	44	99	36
25	1"	A110088/2526	1" 5/16-12	3/4	46	105	36
25	1"	A110088/2533	1" 5/16-12	1"	46	105	41
25	1"	A110088/2542	1" 5/16-12	1" 1/4	51	124	50
30-32	1" 1/4	A110088/3233	1" 5/8-12	1"	52	124	41
30-32	1" 1/4	A110088/3242	1" 5/8-12	1" 1/4	52	124	50
38	1" 1/2	A110088/3842	1" 7/8-12	1" 1/4	59	134	50
38	1" 1/2	A110088/3848	1" 7/8-12	1" 1/2	59	134	55

Prolunga orientabile 90°
JIC cono 37° - GAS cil. (JIS)
con O.R. per sedi JIS 2351
90° (AD) long elbow male
JIC - male JIS
with O.R. JIS 2351 ports
SEDI PAG.31 / PORTS PAG.31

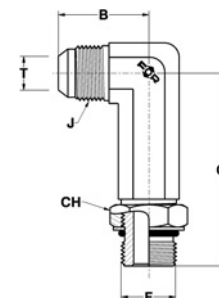

RACCORDI PER TUBI SVASATI - 37°

37° - FLARED TUBE CONNECTORS

110022

Prolunga orientabile 90°
JIC cono 37° - Metrico cil.
con O.R. e rondella
per sedi ISO 9974
90° (AD) long elbow male
JIC - male Metric
with O.R. and retaining ring
ISO 9974 ports

SEDI PAG.32 / PORTS PAG.32

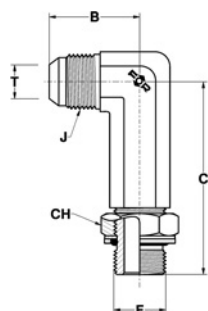

T		RIFERIMENTO REFERENCE	J	F	B	C	CH
MM.	IN.		UNF-UN	METRICO METRIC			
6	1/4	A110022/0610	7/16-20	10x1	22.5	46	14
6	1/4	A110022/0612	7/16-20	12x1,5	27	53.5	17
8	5/16	A110022/0810	1/2-20	10x1	24	49.5	14
8	5/16	A110022/0812	1/2-20	12x1,5	27	53.5	17
8	5/16	A110022/0814	1/2-20	14x1,5	27	56.5	19
10	3/8	A110022/1014	9/16-18	14x1,5	27	56.5	19
10	3/8	A110022/1016	9/16-18	16x1,5	28.5	67	22
12	1/2	A110022/1216	3/4-16	16x1,5	31.5	67	22
12	1/2	A110022/1218	3/4-16	18x1,5	31.5	67	24
14÷16	5/8	A110022/1618	7/8-14	18x1,5	36.5	75	24
14÷16	5/8	A110022/1620	7/8-14	20x1,5	36.5	78	27
14÷16	5/8	A110022/1622	7/8-14	22x1,5	36.5	78	27
18-20	3/4	A110022/2022	1" 1/16-12	22x1,5	42	88	27
18-20	3/4	A110022/2027	1" 1/16-12	27x2	42	95	32
22	7/8	A110022/2226	1" 3/16-12	26x1,5	44	99	36
25	1"	A110022/2527	1" 5/16-12	27x2	46	105	32
25	1"	A110022/2533	1" 5/16-12	33x2	46	105	41
30-32	1" 1/4	A110022/3242	1" 5/8-12	42x2	52	124	50
38	1" 1/2	A110022/3848	1" 7/8-12	48x2	59	141	55
18-20	3/4	SA110022/2018	1" 1/16-12	18x1,5	42	88	24



110077

Prolunga orientabile 90°
 JIC cono 37° - Metrico cil.
 con O.R. per sedi ISO 6149
 90° (ADJ) long elbow male
 JIC - male Metric
 with O.R. ISO 6149 ports

SEDI PAG.30 / PORTS PAG.30

T		RIFERIMENTO REFERENCE	J	F	B	C	CH
MM.	IN.		UNF-UN	METRICO METRIC			
6	1/4	A110077/0610	7/16-20	10x1	22.5	46	14
6	1/4	A110077/0612	7/16-20	12x1,5	27	53.5	17
8	5/16	A110077/0810	1/2-20	10x1	24	49.5	14
8	5/16	A110077/0812	1/2-20	12x1,5	27	53.5	17
8	5/16	A110077/0814	1/2-20	14x1,5	27	56.5	19
10	3/8	A110077/1014	9/16-18	14x1,5	27	56.5	19
10	3/8	A110077/1016	9/16-18	16x1,5	28.5	67	22
12	1/2	A110077/1216	3/4-16	16x1,5	31.5	67	22
12	1/2	A110077/1218	3/4-16	18x1,5	31.5	67	24
14÷16	5/8	A110077/1618	7/8-14	18x1,5	36.5	75	24
14÷16	5/8	A110077/1622	7/8-14	22x1,5	36.5	78	27
18-20	3/4	A110077/2022	1" 1/16-12	22x1,5	42	88	27
18-20	3/4	A110077/2027	1" 1/16-12	27x2	42	95	32
25	1"	A110077/2527	1" 5/16-12	27x2	46	105	32
25	1"	A110077/2533	1" 5/16-12	33x2	46	105	41
30-32	1" 1/4	A110077/3242	1" 5/8-12	42x2	52	124	50
38	1" 1/2	A110077/3848	1" 7/8-12	48x2	59	141	55

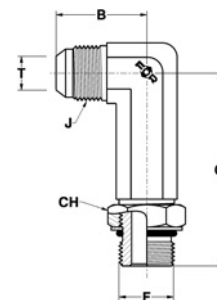

RACCORDI PER TUBI SVASATI - 37°

37° - FLARED TUBE CONNECTORS

110033

Prolunga 90°
JIC cono 37° - NPTF
per sedi SAE 476
90° long elbow male
JIC - male NPTF
taper SAE 476 ports

SEDI PAG.35 / PORTS PAG.35

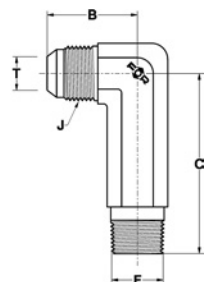

T		RIFERIMENTO REFERENCE	J	F	B	C
MM.	IN.		UNF-UN	NPTF		
6	1/4	A110033/0610	7/16-20	1/8	22.5	39.5
6	1/4	A110033/0613	7/16-20	1/4	27	52.5
8	5/16	A110033/0810	1/2-20	1/8	24	41.5
8	5/16	A110033/0813	1/2-20	1/4	27	52.5
10	3/8	A110033/1010	9/16-18	1/8	27	48.5
10	3/8	A110033/1013	9/16-18	1/4	27	52.5
10	3/8	A110033/1017	9/16-18	3/8	28.5	61
10	3/8	A110033/1021	9/16-18	1/2	31	73
12	1/2	A110033/1213	3/4-16	1/4	31.5	61
12	1/2	A110033/1217	3/4-16	3/8	31.5	61
12	1/2	A110033/1221	3/4-16	1/2	34	73
12	1/2	A110033/1226	3/4-16	3/4	37	82.5
14÷16	5/8	A110033/1617	7/8-14	3/8	36.5	68
14÷16	5/8	A110033/1621	7/8-14	1/2	36.5	73
14÷16	5/8	A110033/1626	7/8-14	3/4	39.5	82.5
18-20	3/4	A110033/2021	1" 1/16-12	1/2	42	82.5
18-20	3/4	A110033/2026	1" 1/16-12	3/4	42	82.5
22	7/8	A110033/2226	1" 3/16-12	3/4	44	92
25	1"	A110033/2526	1" 5/16-12	3/4	46	98
25	1"	A110033/2533	1" 5/16-12	1"	46	103
30-32	1" 1/4	A110033/3233	1" 5/8-12	1"	52	127
30-32	1" 1/4	A110033/3242	1" 5/8-12	1" 1/4	52	127
38	1" 1/2	A110033/3848	1" 7/8-12	1" 1/2	59	141
25	1"	SA110033/2542	1" 5/16-12	1" 1/4	50.5	127
30-32	1" 1/4	SA110033/3248	1" 5/8-12	1" 1/2	56	141



111001

Giunzione a "T" maschi
JIC cono 37°
Union tee male JIC

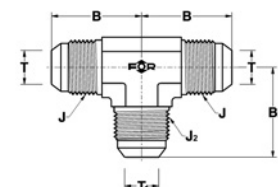

T		T ₁		RIFERIMENTO REFERENCE	J	J ₂	B	B ₂
MM.	IN.	MM.	IN.		UNF-UN	UNF-UN		
6	1/4	6	1/4	A111001/06	7/16-20	7/16-20	23	23
8	5/16	8	5/16	A111001/08	1/2-20	1/2-20	24	24
10	3/8	10	3/8	A111001/10	9/16-18	9/16-18	27	27
12	1/2	12	1/2	A111001/12	3/4-16	3/4-16	31.5	31.5
14÷16	5/8	14÷16	5/8	A111001/16	7/8-14	7/8-14	36.5	36.5
18-20	3/4	18-20	3/4	A111001/20	1" 1/16-12	1" 1/16-12	42	42
22	7/8	22	7/8	A111001/22	1" 3/16-12	1" 3/16-12	44	44
25	1"	25	1"	A111001/25	1" 5/16-12	1" 5/16-12	46	46
30-32	1" 1/4	30-32	1" 1/4	A111001/32	1" 5/8-12	1" 5/8-12	52	52
38	1" 1/2	38	1" 1/2	A111001/38	1" 7/8-12	1" 7/8-12	59	59
6	1/4	10	3/8	SA111001/060610	7/16-20	9/16-18	27	27
8	5/16	8	5/16	SA111001/080806	1/2-20	7/16-20	24	24
8	5/16	8	5/16	SA111001/080810	1/2-20	9/16-18	27	27
8	5/16	8	5/16	SA111001/080812	1/2-20	3/4-16	29	31.5
8	5/16	8	5/16	SA111001/080816	1/2-20	7/8-14	31	36.5
10	3/8	10	3/8	SA111001/101006	9/16-18	7/16-20	27	27
10	3/8	10	3/8	SA111001/101008	9/16-18	1/2-20	27	27
10	3/8	10	3/8	SA111001/101012	9/16-18	3/4-16	28	31.5
10	3/8	10	3/8	SA111001/101016	9/16-18	7/8-14	31	36.5
12	1/2	12	1/2	SA111001/121206	3/4-16	7/16-20	31.5	29
12	1/2	12	1/2	SA111001/121208	3/4-16	1/2-20	31.5	29
12	1/2	12	1/2	SA111001/121210	3/4-16	9/16-18	31.5	29
12	1/2	12	1/2	SA111001/121216	3/4-16	7/8-14	34	36.5
14÷16	5/8	14÷16	5/8	SA111001/161606	7/8-14	7/16-20	36.5	31
14÷16	5/8	14÷16	5/8	SA111001/161608	7/8-14	1/2-20	36.5	31
14÷16	5/8	14÷16	5/8	SA111001/161610	7/8-14	9/16-18	36.5	31
14÷16	5/8	14÷16	5/8	SA111001/161620	7/8-14	1" 1/16-12	40	42
14÷16	5/8	14÷16	5/8	SA111001/161625	7/8-14	1" 5/16-12	42	46
18-20	3/4	18-20	3/4	SA111001/202010	1" 1/16-12	9/16-18	42	34
18-20	3/4	18-20	3/4	SA111001/202012	1" 1/16-12	3/4-16	42	36.5
18-20	3/4	18-20	3/4	SA111001/202016	1" 1/16-12	7/8-14	42	39.5
18-20	3/4	18-20	3/4	SA111001/202022	1" 1/16-12	1" 3/16-12	43	44
18-20	3/4	18-20	3/4	SA111001/202025	1" 1/16-12	1" 5/16-12	44.5	46
25	1"	25	1"	SA111001/252506	1" 5/16-12	7/16-20	46	46
25	1"	25	1"	SA111001/252516	1" 5/16-12	7/8-14	46	42.5
25	1"	25	1"	SA111001/252520	1" 5/16-12	1" 1/16-12	46	44.5
25	1"	25	1"	SA111001/252532	1" 5/16-12	1" 5/8-12	50.5	52
30-32	1" 1/4	30-32	1" 1/4	SA111001/323210	1" 5/8-12	9/16-18	52	41
30-32	1" 1/4	30-32	1" 1/4	SA111001/323225	1" 5/8-12	1" 5/16-12	52	50.5
30-32	1" 1/4	30-32	1" 1/4	SA111001/323238	1" 5/8-12	1" 7/8-12	56	59
50	2"	50	2"	SA111001/50	2" 1/2-12	2" 1/2-12	77.5	77.5

RACCORDI PER TUBI SVASATI - 37°

37° - FLARED TUBE CONNECTORS

111012

Giunzione a "T" maschi
JIC cono 37° - femmina JIC cono
37°
Swivel nut branch tee male JIC

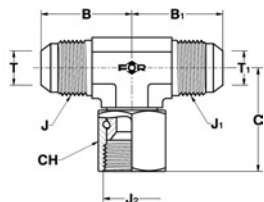

T		T ₁		RIFERIMENTO REFERENCE	J	J ₁	J ₂	B	B ₁	C	CH
MM.	IN.	MM.	IN.		UNF-UN	UNF-UN	UNF-UN				
6	1/4	6	1/4	A111012/06	7/16-20	7/16-20	7/16-20	22.5	22.5	26	14
8	5/16	8	5/16	A111012/08	1/2-20	1/2-20	1/2-20	24	24	28	17
10	3/8	10	3/8	A111012/10	9/16-18	9/16-18	9/16-18	27	27	32	17
12	1/2	12	1/2	A111012/12	3/4-16	3/4-16	3/4-16	31.5	31.5	35,5	22
14÷16	5/8	14÷16	5/8	A111012/16	7/8-14	7/8-14	7/8-14	36.5	36.5	42	27
18-20	3/4	18-20	3/4	A111012/20	1" 1/16-12	1" 1/16-12	1" 1/16-12	42	42	45,5	32
22	7/8	22	7/8	A111012/22	1" 3/16-12	1" 3/16-12	1" 3/16-12	44	44	46,5	36
25	1"	25	1"	A111012/25	1" 5/16-12	1" 5/16-12	1" 5/16-12	46	46	51,5	38
30-32	1" 1/4	30-32	1" 1/4	A111012/32	1" 5/8-12	1" 5/8-12	1" 5/8-12	52	52	59,5	50
38	1" 1/2	38	1" 1/2	A111012/38	1" 7/8-12	1" 7/8-12	1" 7/8-12	59	59	67	57
8	5/16	8	5/16	SA111012/080810	1/2-20	1/2-20	9/16-18	27	27	32	17
10	3/8	12	1/2	SA111012/101212	9/16-18	3/4-16	3/4-16	29	31.5	35,5	22
12	1/2	12	1/2	SA111012/121220	3/4-16	3/4-16	1" 1/16-12	37	37	45,5	32
12	1/2	14÷16	5/8	SA111012/121612	3/4-16	7/8-14	3/4-16	33.5	36.5	39	22
14÷16	5/8	10	3/8	SA111012/161016	7/8-14	9/16-18	7/8-14	36.5	31.5	42	27
14÷16	5/8	12	1/2	SA111012/161216	7/8-14	3/4-16	7/8-14	36.5	34	42	27
14÷16	5/8	14÷16	5/8	SA111012/161612	7/8-14	7/8-14	3/4-16	36.5	36.5	39	22
14÷16	5/8	14÷16	5/8	SA111012/161620	7/8-14	7/8-14	1" 1/16-12	39.5	39.5	45,5	32
14÷16	5/8	25	1"	SA111012/162520	7/8-14	1" 5/16-12	1" 1/16-12	42.5	46	49	32
18-20	3/4	14÷16	5/8	SA111012/201616	1" 1/16-12	7/8-14	7/8-14	42	39.5	44	27
18-20	3/4	14÷16	5/8	SA111012/201620	1" 1/16-12	7/8-14	1" 1/16-12	42	39.5	45,5	32
18-20	3/4	18-20	3/4	SA111012/202012	1" 1/16-12	1" 1/16-12	3/4-16	42	42	41	22
18-20	3/4	18-20	3/4	SA111012/202016	1" 1/16-12	1" 1/16-12	7/8-14	42	42	44	27
18-20	3/4	18-20	3/4	SA111012/202025	1" 1/16-12	1" 1/16-12	1" 5/16-12	45	45	51,5	38
18-20	3/4	25	1"	SA111012/202520	1" 1/16-12	1" 5/16-12	1" 1/16-12	44.5	46	49	32
18-20	3/4	25	1"	SA111012/202525	1" 1/16-12	1" 5/16-12	1" 5/16-12	45	46	51,5	38
25	1"	14÷16	5/8	SA111012/251625	1" 5/16-12	7/8-14	1" 5/16-12	46	41.5	51,5	38
25	1"	25	1"	SA111012/252516	1" 5/16-12	1" 5/16-12	7/8-14	46	46	47,5	27
25	1"	25	1"	SA111012/252520	1" 5/16-12	1" 5/16-12	1" 1/16-12	46	46	49	32
30-32	1" 1/4	25	1"	SA111012/322532	1" 5/8-12	1" 5/16-12	1" 5/8-12	52	50.5	59,5	50
30-32	1" 1/4	30-32	1" 1/4	SA111012/323225	1" 5/8-12	1" 5/8-12	1" 5/16-12	52	52	57	38
38	1" 1/2	25	1"	SA111012/382538	1" 7/8-12	1" 5/16-12	1" 7/8-12	59	54.5	65	57



T		T ₁		RIFERIMENTO REFERENCE	J	J ₁	F	B	B ₁	C	CH
MM.	IN.	MM.	IN.		UNF-UN	UNF-UN	UNF-UN				
6	1/4	6	1/4	A111023/0611	7/16-20	7/16-20	7/16-20	22,5	22,5	27,5	14
6	1/4	6	1/4	A111023/0612	7/16-20	7/16-20	1/2-20	24	24	27,5	17
6	1/4	6	1/4	A111023/0614	7/16-20	7/16-20	9/16-18	27	27	31,5	17
8	5/16	8	5/16	A111023/0812	1/2-20	1/2-20	1/2-20	24	24	27	17
10	3/8	10	3/8	A111023/1014	9/16-18	9/16-18	9/16-18	27	27	31,5	17
10	3/8	10	3/8	A111023/1019	9/16-18	9/16-18	3/4-16	28,5	28,5	36,5	22
12	1/2	12	1/2	A111023/1219	3/4-16	3/4-16	3/4-16	31,5	31,5	36,5	22
12	1/2	12	1/2	A111023/1222	3/4-16	3/4-16	7/8-14	34	34	43	27
12	1/2	12	1/2	A111023/1227	3/4-16	3/4-16	1" 1/16-12	37	37	49	32
14÷16	5/8	14÷16	5/8	A111023/1619	7/8-14	7/8-14	3/4-16	36,5	36,5	39,5	22
14÷16	5/8	14÷16	5/8	A111023/1622	7/8-14	7/8-14	7/8-14	36,5	36,5	43	27
14÷16	5/8	14÷16	5/8	A111023/1627	7/8-14	7/8-14	1" 1/16-12	39,5	39,5	49	32
18-20	3/4	18-20	3/4	A111023/2019	1" 1/16-12	1" 1/16-12	3/4-16	42	42	42	22
18-20	3/4	18-20	3/4	A111023/2022	1" 1/16-12	1" 1/16-12	7/8-14	42	42	45,5	27
18-20	3/4	18-20	3/4	A111023/2027	1" 1/16-12	1" 1/16-12	1" 1/16-12	42	42	49	32
18-20	3/4	18-20	3/4	A111023/2033	1" 1/16-12	1" 1/16-12	1" 5/16-12	44,5	44,5	52	38
22	7/8	22	7/8	A111023/2230	1" 3/16-12	1" 3/16-12	1" 3/16-12	44	44	50,5	35
25	1"	25	1"	A111023/2527	1" 5/16-12	1" 5/16-12	1" 1/16-12	46	46	52	32
25	1"	25	1"	A111023/2533	1" 5/16-12	1" 5/16-12	1" 5/16-12	46	46	52	38
25	1"	25	1"	A111023/2541	1" 5/16-12	1" 5/16-12	1" 5/8-12	51	51	57	50
30-32	1" 1/4	30-32	1" 1/4	A111023/3241	1" 5/8-12	1" 5/8-12	1" 5/8-12	52	52	57	50
38	1" 1/2	38	1" 1/2	A111023/3848	1" 7/8-12	1" 7/8-12	1" 7/8-12	59	59	61	55
12	1/2	10	3/8	SA111023/121014	3/4-16	9/16-18	9/16-18	31,5	29	33,5	17
12	1/2	12	1/2	SA111023/121212	3/4-16	3/4-16	1/2-20	31,5	31,5	32	17
12	1/2	12	1/2	SA111023/121214	3/4-16	3/4-16	9/16-18	31,5	31,5	33,5	17
14÷16	5/8	14÷16	5/8	SA111023/161630	7/8-14	7/8-14	1" 3/16-12	42,5	42,5	50,5	35
14÷16	5/8	18-20	3/4	SA111023/162027	7/8-14	1" 1/16-12	1" 1/16-12	39,5	42	49	32
25	1"	18-20	3/4	SA111023/252027	1" 5/16-12	1" 1/16-12	1" 1/16-12	46	45	52	32

111023

Terminale orientabile a "T"
JIC cono 37° - SAE UNF-UN
per sedi ISO 11926
Branch (ADJ) tee male
JIC - male SAE UNF-UN
with O.R. ISO 11926 ports
SEDI PAG.30 / PORTS PAG.30

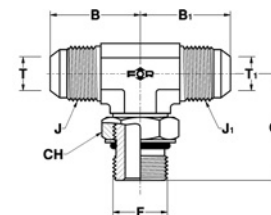

RACCORDI PER TUBI SVASATI - 37°

37° - FLARED TUBE CONNECTORS

111034

Terminale orientabile a "T"
 JIC cono 37° - GAS cil. (BSPP)
 con O.R. e rondella
 per sedi ISO 1179
 Branch (AD) tee male
 JIC - male BSPP
 with O.R. and retaining ring
 ISO 1179 ports

SEDI PAG.32 / PORTS PAG.32

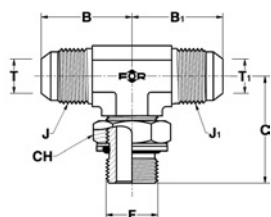

T		T ₁		RIFERIMENTO REFERENCE	J	J ₁	F	B	B ₁	C	CH
MM.	IN.	MM.	IN.		UNF-UN	UNF-UN	GAS CIL.BSPP				
6	1/4	6	1/4	A111034/0610	7/16-20	7/16-20	1/8	22.5	22.5	26	14
6	1/4	6	1/4	A111034/0613	7/16-20	7/16-20	1/4	27	27	31.5	19
6	1/4	6	1/4	A111034/0617	7/16-20	7/16-20	3/8	28.5	28.5	36.5	22
6	1/4	6	1/4	A111034/0621	7/16-20	7/16-20	1/2	31	31	43	27
8	5/16	8	5/16	A111034/0810	1/2-20	1/2-20	1/8	24	24	28.5	14
8	5/16	8	5/16	A111034/0813	1/2-20	1/2-20	1/4	27	27	31.5	19
8	5/16	8	5/16	A111034/0817	1/2-20	1/2-20	3/8	28.5	28.5	36.5	22
10	3/8	10	3/8	A111034/1013	9/16-18	9/16-18	1/4	27	27	31.5	19
10	3/8	10	3/8	A111034/1017	9/16-18	9/16-18	3/8	28.5	28.5	36.5	22
10	3/8	10	3/8	A111034/1021	9/16-18	9/16-18	1/2	31	31	43	27
12	1/2	12	1/2	A111034/1213	3/4-16	3/4-16	1/4	31.5	31.5	33.5	19
12	1/2	12	1/2	A111034/1217	3/4-16	3/4-16	3/8	31.5	31.5	36.5	22
12	1/2	12	1/2	A111034/1221	3/4-16	3/4-16	1/2	34	34	43	27
12	1/2	12	1/2	A111034/1226	3/4-16	3/4-16	3/4	37	37	49	36
14÷16	5/8	14÷16	5/8	A111034/1617	7/8-14	7/8-14	3/8	36.5	36.5	39.5	22
14÷16	5/8	14÷16	5/8	A111034/1621	7/8-14	7/8-14	1/2	36.5	36.5	43	27
14÷16	5/8	14÷16	5/8	A111034/1626	7/8-14	7/8-14	3/4	39.5	39.5	49	36
18-20	3/4	18-20	3/4	A111034/2021	1"1/16-12	1"1/16-12	1/2	42	42	45.5	27
18-20	3/4	18-20	3/4	A111034/2026	1"1/16-12	1"1/16-12	3/4	42	42	49	36
18-20	3/4	18-20	3/4	A111034/2033	1"1/16-12	1"1/16-12	1"	44.5	44.5	52	41
22	7/8	22	7/8	A111034/2226	1"3/16-12	1"3/16-12	3/4	44	44	50.5	36
25	1"	25	1"	A111034/2526	1"5/16-12	1"5/16-12	3/4	46	46	52	36
25	1"	25	1"	A111034/2533	1"5/16-12	1"5/16-12	1"	46	46	52	41
25	1"	25	1"	A111034/2542	1"5/16-12	1"5/16-12	1"1/4	51	51	57	50
30-32	1"1/4	30-32	1"1/4	A111034/3233	1"5/8-12	1"5/8-12	1"	52	52	57	41
30-32	1"1/4	30-32	1"1/4	A111034/3242	1"5/8-12	1"5/8-12	1"1/4	52	52	57	50
38	1"1/2	38	1"1/2	A111034/3842	1"7/8-12	1"7/8-12	1"1/4	59	59	61	50
38	1"1/2	38	1"1/2	A111034/3848	1"7/8-12	1"7/8-12	1"1/2	59	59	61	60
8	5/16	8	5/16	SA111034/080821	1/2-20	1/2-20	1/2	31	31	43	27
8	5/16	18-20	3/4	SA111034/082021	1/2-20	1"1/16-12	1/2	34	42	45.5	27
10	3/8	8	5/16	SA111034/100813	9/16-18	1/2-20	1/4	27	27	31.5	19
10	3/8	10	3/8	SA111034/101026	9/16-18	9/16-18	3/4	34.5	34.5	49	36
10	3/8	14÷16	5/8	SA111034/101621	9/16-18	7/8-14	1/2	31.5	36.5	43	27
10	3/8	18-20	3/4	SA111034/102021	9/16-18	1"1/16-12	1/2	34.5	42	45.5	27
12	1/2	6	1/4	SA111034/120617	3/4-16	7/16-20	3/8	31.5	29	36.5	22
14÷16	5/8	8	5/16	SA111034/160821	7/8-14	1/2-20	1/2	36.5	31	43	27
14÷16	5/8	12	1/2	SA111034/161217	7/8-14	3/4-16	3/8	36.5	34	39.5	22
18-20	3/4	18-20	3/4	SA111034/202017	1"1/16-12	1"1/16-12	3/8	42	42	42	22
25	1"	38	1"1/2	SA111034/253848	1"5/16-12	1"7/8-12	1"1/2	54.5	59	61	60
30-32	1"1/4	30-32	1"1/4	SA111034/3226	1"5/8-12	1"5/8-12	3/4	52	52	54.5	36



T		T ₁		RIFERIMENTO REFERENCE	J	J ₁	F	B	B ₁	C	CH
MM.	IN.	MM.	IN.		UNF-UN	UNF-UN	GAS CIL-JIS				
6	1/4	6	1/4	A111166/0610	7/16-20	7/16-20	1/8	22.5	22.5	26	14
6	1/4	6	1/4	A111166/0613	7/16-20	7/16-20	1/4	27	27	31.5	19
6	1/4	6	1/4	A111166/0617	7/16-20	7/16-20	3/8	28.5	28.5	36.5	22
6	1/4	6	1/4	A111166/0621	7/16-20	7/16-20	1/2	31	31	43	27
8	5/16	8	5/16	A111166/0810	1/2-20	1/2-20	1/8	24	24	28.5	14
8	5/16	8	5/16	A111166/0813	1/2-20	1/2-20	1/4	27	27	31.5	19
8	5/16	8	5/16	A111166/0817	1/2-20	1/2-20	3/8	28.5	28.5	36.5	22
8	5/16	8	5/16	A111166/080821	1/2-20	1/2-20	1/2	31	31	43	27
8	5/16	14÷16	5/8	A111166/081621	1/2-20	7/8-14	1/2	31	36.5	43	27
8	5/16	18-20	3/4	A111166/082021	1/2-20	1" 1/16-12	1/2	34	42	45.5	27
10	3/8	8	5/16	A111166/100813	9/16-18	1/2-20	1/4	27	27	31.5	19
10	3/8	10	3/8	A111166/1013	9/16-18	9/16-18	1/4	27	27	31.5	19
10	3/8	10	3/8	A111166/1017	9/16-18	9/16-18	3/8	28.5	28.5	36.5	22
10	3/8	10	3/8	A111166/1021	9/16-18	9/16-18	1/2	31	31	43	27
10	3/8	10	3/8	A111166/101026	9/16-18	9/16-18	3/4	34.5	34.5	49	36
10	3/8	14÷16	5/8	A111166/101621	9/16-18	7/8-14	1/2	31.5	36.5	43	27
10	3/8	18-20	3/4	A111166/102021	9/16-18	1" 1/16-12	1/2	34.5	42	45.5	27
12	1/2	6	1/4	A111166/120617	3/4-16	7/16-20	3/8	31.5	29	36.5	22
12	1/2	12	1/2	A111166/1213	3/4-16	3/4-16	1/4	31.5	31.5	33.5	19
12	1/2	12	1/2	A111166/1217	3/4-16	3/4-16	3/8	31.5	31.5	36.5	22
12	1/2	12	1/2	A111166/1221	3/4-16	3/4-16	1/2	34	34	43	27
12	1/2	12	1/2	A111166/1226	3/4-16	3/4-16	3/4	37	37	49	36
14÷16	5/8	8	5/16	A111166/160821	7/8-14	1/2-20	1/2	36.5	31	43	27
14÷16	5/8	12	1/2	A111166/161217	7/8-14	3/4-16	3/8	36.5	34	39.5	22
14÷16	5/8	14÷16	5/8	A111166/1617	7/8-14	7/8-14	3/8	36.5	36.5	39.5	22
14÷16	5/8	14÷16	5/8	A111166/1621	7/8-14	7/8-14	1/2	36.5	36.5	43	27
14÷16	5/8	14÷16	5/8	A111166/1626	7/8-14	7/8-14	3/4	39.5	39.5	49	36
18-20	3/4	18-20	3/4	A111166/202017	1" 1/16-12	1" 1/16-12	3/8	42	42	42	22
18-20	3/4	18-20	3/4	A111166/2021	1" 1/16-12	1" 1/16-12	1/2	42	42	45.5	27
18-20	3/4	18-20	3/4	A111166/2026	1" 1/16-12	1" 1/16-12	3/4	42	42	49	36
18-20	3/4	18-20	3/4	A111166/2033	1" 1/16-12	1" 1/16-12	1"	44.5	44.5	52	41
22	7/8	22	7/8	A111166/2226	1" 3/16-12	1" 3/16-12	3/4	44	44	50.5	36
25	1"	25	1"	A111166/2526	1" 5/16-12	1" 5/16-12	3/4	46	46	52	36
25	1"	25	1"	A111166/2533	1" 5/16-12	1" 5/16-12	1"	46	46	52	41
25	1"	25	1"	A111166/2542	1" 5/16-12	1" 5/16-12	1" 1/4	51	51	57	50
25	1"	38	1" 1/2	A111166/253848	1" 5/16-12	1" 7/8-12	1" 1/2	54.5	59	61	55
30-32	1" 1/4	30-32	1" 1/4	A111166/323226	1" 5/8-12	1" 5/8-12	3/4	52	52	54.5	36
30-32	1" 1/4	30-32	1" 1/4	A111166/3233	1" 5/8-12	1" 5/8-12	1"	52	52	57	41
30-32	1" 1/4	30-32	1" 1/4	A111166/3242	1" 5/8-12	1" 5/8-12	1" 1/4	52	52	57	50
38	1" 1/2	38	1" 1/2	A111166/3842	1" 7/8-12	1" 7/8-12	1" 1/4	59	59	61	50
38	1" 1/2	38	1" 1/2	A111166/3848	1" 7/8-12	1" 7/8-12	1" 1/2	59	59	61	55

111166

Terminale orientabile a "T"
JIC cono 37° - GAS cil. (JIS)
con O.R. per sedi JIS 2351
Branch (ADJ) tee male
JIC - male JIS
with O.R. JIS 2351 ports
SEDI PAG.31 / PORTS PAG.31

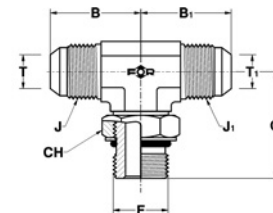

RACCORDI PER TUBI SVASATI - 37°

37° - FLARED TUBE CONNECTORS

111045

Terminale orientabile a "T"
 JIC cono 37° - Metrico cil.
 con O.R. e rondella
 per sedi ISO 9974
 Branch (AD) tee male
 JIC - male Metric
 with O.R. and retaining ring
 ISO 9974 ports

SEDI PAG.32 / PORTS PAG.32

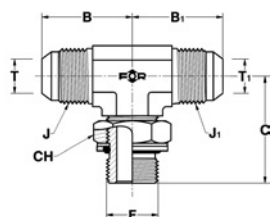

T		T ₁		RIFERIMENTO REFERENCE	J	J ₁	F	B	B ₁	C	CH
MM.	IN.	MM.	IN.		UNF-UN	UNF-UN	METRICO METRIC				
6	1/4	6	1/4	A111045/0610	7/16-20	7/16-20	10x1	22,5	22,5	27,5	14
6	1/4	6	1/4	A111045/0612	7/16-20	7/16-20	12x1,5	27	27	31,5	17
8	5/16	8	5/16	A111045/0810	1/2-20	1/2-20	10x1	24	24	27,5	14
8	5/16	8	5/16	A111045/0812	1/2-20	1/2-20	12x1,5	27	27	31,5	17
8	5/16	8	5/16	A111045/0814	1/2-20	1/2-20	14x1,5	27	27	32,5	19
10	3/8	10	3/8	A111045/1014	9/16-18	9/16-18	14x1,5	27	27	32,5	19
10	3/8	10	3/8	A111045/1016	9/16-18	9/16-18	16x1,5	28,5	28,5	36,5	22
12	1/2	12	1/2	A111045/1216	3/4-16	3/4-16	16x1,5	31,5	31,5	36,5	22
12	1/2	12	1/2	A111045/1218	3/4-16	3/4-16	18x1,5	31,5	31,5	39,5	24
14÷16	5/8	14÷16	5/8	A111045/1618	7/8-14	7/8-14	18x1,5	36,5	36,5	42	24
14÷16	5/8	14÷16	5/8	A111045/1620	7/8-14	7/8-14	20x1,5	36,5	36,5	43	27
14÷16	5/8	14÷16	5/8	A111045/1622	7/8-14	7/8-14	22x1,5	36,5	36,5	43	27
18-20	3/4	18-20	3/4	A111045/2022	1" 1/16-12	1" 1/16-12	22x1,5	42	42	45,5	27
18-20	3/4	18-20	3/4	A111045/2027	1" 1/16-12	1" 1/16-12	27x2	42	42	51,5	32
22	7/8	22	7/8	A111045/2226	1" 3/16-12	1" 3/16-12	26x1,5	44	44	50,5	36
25	1"	25	1"	A111045/2527	1" 5/16-12	1" 5/16-12	27x2	46	46	55	32
25	1"	25	1"	A111045/2533	1" 5/16-12	1" 5/16-12	33x2	46	46	55	41
30-32	1" 1/4	30-32	1" 1/4	A111045/3242	1" 5/8-12	1" 5/8-12	42x2	52	52	60	50
38	1" 1/2	38	1" 1/2	A111045/3848	1" 7/8-12	1" 7/8-12	48x2	59	59	67	55
6	1/4	6	1/4	SA111045/060614	7/16-20	7/16-20	14x1,5	27	27	32,5	19
8	5/16	6	1/4	SA111045/080614	1/2-20	7/16-20	14x1,5	27	27	32,5	19
8	5/16	10	3/8	SA111045/081012	1/2-20	9/16-18	12x1,5	27	27	32,5	17
8	5/16	14÷16	5/8	SA111045/081616	1/2-20	7/8-14	16x1,5	31	36,5	39	22
10	3/8	10	3/8	SA111045/101018	9/16-18	9/16-18	18x1,5	29,5	29,5	39,5	24
12	1/2	14÷16	5/8	SA111045/121618	3/4-16	7/8-14	18x1,5	33,5	36,5	42	24
14÷16	5/8	10	3/8	SA111045/161018	7/8-14	9/16-18	18x1,5	36,5	31	42	24
14÷16	5/8	10	3/8	SA111045/161022	7/8-14	9/16-18	22x1,5	36,5	31	43	27
18-20	3/4	18-20	3/4	SA111045/202018	1" 1/16-12	1" 1/16-12	18x1,5	42	42	45,5	24



T		T ₁		RIFERIMENTO REFERENCE	J	J ₁	F	B	B ₁	C	CH
MM.	IN.	MM.	IN.		UNF-UN	UNF-UN	METRICO METRIC				
6	1/4	6	1/4	A111122/0610	7/16-20	7/16-20	10x1	22,5	22,5	27,5	14
6	1/4	6	1/4	A111122/0612	7/16-20	7/16-20	12x1,5	27	27	31,5	17
8	5/16	8	5/16	A111122/0810	1/2-20	1/2-20	10x1	24	24	27,5	14
8	5/16	8	5/16	A111122/0812	1/2-20	1/2-20	12x1,5	27	27	31,5	17
8	5/16	8	5/16	A111122/0814	1/2-20	1/2-20	14x1,5	27	27	32,5	19
10	3/8	10	3/8	A111122/1014	9/16-18	9/16-18	14x1,5	27	27	32,5	19
10	3/8	10	3/8	A111122/1016	9/16-18	9/16-18	16x1,5	28,5	28,5	36,5	22
12	1/2	12	1/2	A111122/1216	3/4-16	3/4-16	16x1,5	31,5	31,5	36,5	22
12	1/2	12	1/2	A111122/1218	3/4-16	3/4-16	18x1,5	31,5	31,5	39,5	24
14÷16	5/8	14÷16	5/8	A111122/1618	7/8-14	7/8-14	18x1,5	36,5	36,5	42	24
14÷16	5/8	14÷16	5/8	A111122/1622	7/8-14	7/8-14	22x1,5	36,5	36,5	43	27
18-20	3/4	18-20	3/4	A111122/2022	1" 1/16-12	1" 1/16-12	22x1,5	42	42	45,5	27
18-20	3/4	18-20	3/4	A111122/2027	1" 1/16-12	1" 1/16-12	27x2	42	42	51,5	32
25	1"	25	1"	A111122/2527	1" 5/16-12	1" 5/16-12	27x2	46	46	55	32
25	1"	25	1"	A111122/2533	1" 5/16-12	1" 5/16-12	33x2	46	46	55	41
30-32	1" 1/4	30-32	1" 1/4	A111122/3242	1" 5/8-12	1" 5/8-12	42x2	52	52	60	50
38	1" 1/2	38	1" 1/2	A111122/3848	1" 7/8-12	1" 7/8-12	48x2	59	59	67	55
12	1/2	14÷16	5/8	SA111122/121618	3/4-16	7/8-14	18x1,5	33,5	36,5	42	24

111122

Terminale orientabile a "T"
JIC cono 37° - Metrico cil.
con O.R. per sedi ISO 6149
Branch (ADJ) tee male
JIC - male Metric
with O.R. ISO 6149 ports

SEDI PAG.30 / PORTS PAG.30

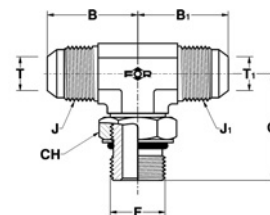

T		T ₁		RIFERIMENTO REFERENCE	J	J ₁	F	B	B ₁	C
MM.	IN.	MM.	IN.		UNF-UN	UNF-UN	NPTF			
6	1/4	6	1/4	A111056/0610	7/16-20	7/16-20	1/8	22,5	22,5	19,5
6	1/4	6	1/4	A111056/0613	7/16-20	7/16-20	1/4	27	27	27,5
8	5/16	8	5/16	A111056/0810	1/2-20	1/2-20	1/8	24	24	19,5
8	5/16	8	5/16	A111056/0813	1/2-20	1/2-20	1/4	27	27	27,5
10	3/8	10	3/8	A111056/1013	9/16-18	9/16-18	1/4	27	27	27,5
10	3/8	10	3/8	A111056/1017	9/16-18	9/16-18	3/8	28,5	28,5	31
10	3/8	10	3/8	A111056/1021	9/16-18	9/16-18	1/2	31	31	37
12	1/2	12	1/2	A111056/1213	3/4-16	3/4-16	1/4	31,5	31,5	31
12	1/2	12	1/2	A111056/1217	3/4-16	3/4-16	3/8	31,5	31,5	31
12	1/2	12	1/2	A111056/1221	3/4-16	3/4-16	1/2	34	34	37
12	1/2	12	1/2	A111056/1226	3/4-16	3/4-16	3/4	37	37	40,5
14÷16	5/8	14÷16	5/8	A111056/1617	7/8-14	7/8-14	3/8	36,5	36,5	32
14÷16	5/8	14÷16	5/8	A111056/1621	7/8-14	7/8-14	1/2	36,5	36,5	37
14÷16	5/8	14÷16	5/8	A111056/1626	7/8-14	7/8-14	3/4	39,5	39,5	40,5
18-20	3/4	18-20	3/4	A111056/2021	1" 1/16-12	1" 1/16-12	1/2	42	42	40,5
18-20	3/4	18-20	3/4	A111056/2026	1" 1/16-12	1" 1/16-12	3/4	42	42	40,5
22	7/8	22	7/8	A111056/2226	1" 3/16-12	1" 3/16-12	3/4	44	44	43
25	1"	25	1"	A111056/2526	1" 5/16-12	1" 5/16-12	3/4	46	46	45
25	1"	25	1"	A111056/2533	1" 5/16-12	1" 5/16-12	1"	46	46	50
30-32	1" 1/4	30-32	1" 1/4	A111056/3233	1" 5/8-12	1" 5/8-12	1"	52	52	59
30-32	1" 1/4	30-32	1" 1/4	A111056/3242	1" 5/8-12	1" 5/8-12	1" 1/4	52	52	60
38	1" 1/2	38	1" 1/2	A111056/3848	1" 7/8-12	1" 7/8-12	1" 1/2	59	59	67
10	3/8	10	3/8	SA111056/101010	9/16-18	9/16-18	1/8	27	27	23,5
38	1" 1/2	38	1" 1/2	SA111056/383842	1" 7/8-12	1" 7/8-12	1" 1/4	59	59	66

111056

Terminale a "T"
JIC cono 37° - NPTF
per sedi SAE 476
Branch tee male
JIC - male NPTF
taper SAE 476 ports

SEDI PAG.35 / PORTS PAG.35

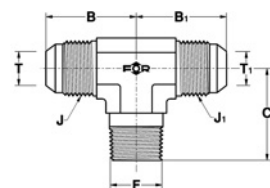

RACCORDI PER TUBI SVASATI - 37°

37° - FLARED TUBE CONNECTORS

111067

Terminale a "T"
 JIC cono 37° - GAS conico (BSPT)
 per sedi ISO 7
 Branch tee male
 JIC - male BSPT
 taper ISO 7 ports

SEDI PAG.35 / PORTS PAG.35

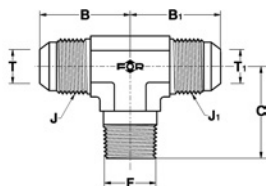

T		T ₁		RIFERIMENTO REFERENCE	J	J ₁	F	B	B ₁	C
MM.	IN.	MM.	IN.		UNF-UN	UNF-UN	GAS CON.BSPT			
6	1/4	6	1/4	A111067/0610	7/16-20	7/16-20	1/8	22.5	22.5	19.5
6	1/4	6	1/4	A111067/0613	7/16-20	7/16-20	1/4	27	27	27.5
8	5/16	8	5/16	A111067/0810	1/2-20	1/2-20	1/8	24	24	19.5
8	5/16	8	5/16	A111067/0813	1/2-20	1/2-20	1/4	27	27	27.5
10	3/8	10	3/8	A111067/1013	9/16-18	9/16-18	1/4	27	27	27.5
10	3/8	10	3/8	A111067/1017	9/16-18	9/16-18	3/8	28.5	28.5	31
10	3/8	10	3/8	A111067/1021	9/16-18	9/16-18	1/2	31	31	37
12	1/2	12	1/2	A111067/1213	3/4-16	3/4-16	1/4	31.5	31.5	31
12	1/2	12	1/2	A111067/1217	3/4-16	3/4-16	3/8	31.5	31.5	31
12	1/2	12	1/2	A111067/1221	3/4-16	3/4-16	1/2	34	34	37
14÷16	5/8	14÷16	5/8	A111067/1617	7/8-14	7/8-14	3/8	36.5	36.5	32
14÷16	5/8	14÷16	5/8	A111067/1621	7/8-14	7/8-14	1/2	36.5	36.5	37
14÷16	5/8	14÷16	5/8	A111067/1626	7/8-14	7/8-14	3/4	39.5	39.5	40.5
18-20	3/4	18-20	3/4	A111067/2021	1" 1/16-12	1" 1/16-12	1/2	42	42	40.5
18-20	3/4	18-20	3/4	A111067/2026	1" 1/16-12	1" 1/16-12	3/4	42	42	40.5
18-20	3/4	18-20	3/4	A111067/2033	1" 1/16-12	1" 1/16-12	1"	45	45	50
22	7/8	22	7/8	A111067/2226	1" 3/16-12	1" 3/16-12	3/4	44	44	43
25	1"	25	1"	A111067/2526	1" 5/16-12	1" 5/16-12	3/4	46	46	44.5
25	1"	25	1"	A111067/2533	1" 5/16-12	1" 5/16-12	1"	46	46	50
30-32	1" 1/4	30-32	1" 1/4	A111067/3233	1" 5/8-12	1" 5/8-12	1"	52	52	59
30-32	1" 1/4	30-32	1" 1/4	A111067/3242	1" 5/8-12	1" 5/8-12	1" 1/4	52	52	60
38	1" 1/2	38	1" 1/2	A111067/3848	1" 7/8-12	1" 7/8-12	1" 1/2	59	59	67
10	3/8	10	3/8	SA111067/101026	9/16-18	9/16-18	3/4	34	34	40.5
25	1"	14÷16	5/8	SA111067/251648	1" 5/16-12	7/8-14	1" 1/2	54.5	50.5	67

111089

Giunzione a "T" maschi
 JIC cono 37° - femmina NPTF
 Branch tee male
 JIC - female NPTF

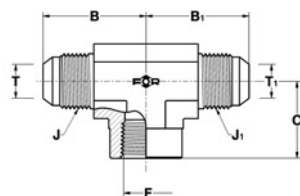

T		T ₁		RIFERIMENTO REFERENCE	J	J ₁	F	B	B ₁	C
MM.	IN.	MM.	IN.		UNF-UN	UNF-UN	NPTF			
6	1/4	6	1/4	A111089/0610	7/16-20	7/16-20	1/8	27	27	16.5
6	1/4	6	1/4	A111089/0613	7/16-20	7/16-20	1/4	31	31	22.5
8	5/16	8	5/16	A111089/0810	1/2-20	1/2-20	1/8	27	27	16.5
8	5/16	8	5/16	A111089/0813	1/2-20	1/2-20	1/4	31	31	22.5
10	3/8	10	3/8	A111089/1010	9/16-18	9/16-18	1/8	27	27	16.5
10	3/8	10	3/8	A111089/1013	9/16-18	9/16-18	1/4	31	31	22.5
10	3/8	10	3/8	A111089/1017	9/16-18	9/16-18	3/8	33	33	26
12	1/2	12	1/2	A111089/1213	3/4-16	3/4-16	1/4	32	32	22.5
12	1/2	12	1/2	A111089/1217	3/4-16	3/4-16	3/8	36	36	26
12	1/2	12	1/2	A111089/1221	3/4-16	3/4-16	1/2	39	39	31
14÷16	5/8	14÷16	5/8	A111089/1621	7/8-14	7/8-14	1/2	41.5	41.5	31
18-20	3/4	18-20	3/4	A111089/2021	1" 1/16-12	1" 1/16-12	1/2	42	42	31
18-20	3/4	18-20	3/4	A111089/2026	1" 1/16-12	1" 1/16-12	3/4	48	48	34.5
22	7/8	22	7/8	A111089/2226	1" 3/16-12	1" 3/16-12	3/4	47	47	36
25	1"	25	1"	A111089/2533	1" 5/16-12	1" 5/16-12	1"	55	55	41
30-32	1" 1/4	30-32	1" 1/4	A111089/3242	1" 5/8-12	1" 5/8-12	1" 1/4	59	59	43
38	1" 1/2	38	1" 1/2	A111089/3848	1" 7/8-12	1" 7/8-12	1" 1/2	73.5	73.5	52.5
10	3/8	10	3/8	SA111089/1021	9/16-18	9/16-18	1/2	36	36	31

FOR S.P.A. - NORME E DIMENSIONI SOGGETTE A MODIFICHE SENZA PREAVVISO.
 FOR S.P.A. - DESIGN DETAILS AND SPECIFICATIONS SUBJECT TO CHANGE WITHOUT PRIOR NOTICE.



T		T ₁		RIFERIMENTO REFERENCE	J	J ₁	F	B	B ₁	C
MM.	IN.	MM.	IN.		UNF-UN	UNF-UN	GAS CIL./JIS			
6	1/4	6	1/4	A111090/0610	7/16-20	7/16-20	1/8	27	27	16.5
6	1/4	6	1/4	A111090/0613	7/16-20	7/16-20	1/4	31	31	22.5
6	1/4	6	1/4	A111090/0617	7/16-20	7/16-20	3/8	33	33	26
8	5/16	8	5/16	A111090/0810	1/2-20	1/2-20	1/8	27	27	16.5
8	5/16	8	5/16	A111090/0813	1/2-20	1/2-20	1/4	31	31	22.5
10	3/8	10	3/8	A111090/1013	9/16-18	9/16-18	1/4	31	31	22.5
10	3/8	10	3/8	A111090/1017	9/16-18	9/16-18	3/8	33	33	26
10	3/8	10	3/8	A111090/1021	9/16-18	9/16-18	1/2	36	36	31
12	1/2	12	1/2	A111090/1213	3/4-16	3/4-16	1/4	32	32	22.5
12	1/2	12	1/2	A111090/1217	3/4-16	3/4-16	3/8	36	36	26
12	1/2	12	1/2	A111090/1221	3/4-16	3/4-16	1/2	39	39	31
14÷16	5/8	14÷16	5/8	A111090/1621	7/8-14	7/8-14	1/2	41.5	41.5	31
18-20	3/4	18-20	3/4	A111090/2021	1" 1/16-12	1" 1/16-12	1/2	42	42	31
18-20	3/4	18-20	3/4	A111090/2026	1" 1/16-12	1" 1/16-12	3/4	48	48	34.5
22	7/8	22	7/8	A111090/2226	1" 3/16-12	1" 3/16-12	3/4	47	47	36
25	1"	25	1"	A111090/2533	1" 5/16-12	1" 5/16-12	1"	55	55	41
30-32	1" 1/4	30-32	1" 1/4	A111090/3233	1" 5/8-12	1" 5/8-12	1"	55	55	41
30-32	1" 1/4	30-32	1" 1/4	A111090/3242	1" 5/8-12	1" 5/8-12	1" 1/4	59	59	43
38	1" 1/2	38	1" 1/2	A111090/3842	1" 7/8-12	1" 7/8-12	1" 1/4	59	59	43
38	1" 1/2	38	1" 1/2	A111090/3848	1" 7/8-12	1" 7/8-12	1" 1/2	73,5	73,5	52,5
10	3/8	10	3/8	SA111090/1010	9/16-18	9/16-18	1/8	27	27	16.5
14÷16	5/8	14÷16	5/8	SA111090/1613	7/8-14	7/8-14	1/4	36.5	36.5	30
14÷16	5/8	14÷16	5/8	SA111090/1617	7/8-14	7/8-14	3/8	36	36	30
14÷16	5/8	14÷16	5/8	SA111090/1621	7/8-14	7/8-14	1/2	41,5	41,5	22
18-20	3/4	18-20	3/4	SA111090/2013	1" 1/16-12	1" 1/16-12	1/4	42	42	30.5

111090

Giunzione a "T" maschi
JIC cono 37° - femmina
GAS cil. (BSPP)
Branch tee male
JIC - female BSPP

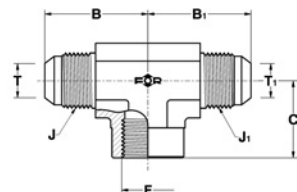

T		RIFERIMENTO REFERENCE	J	B	C	D	CH
MM.	IN.		UNF-UN				
6	1/4	A112002/06	7/16-20	24.5	40.5	28,5	17
8	5/16	A112002/08	1/2-20	26	41	28,5	19
10	3/8	A112002/10	9/16-18	27.5	46	30	22
12	1/2	A112002/12	3/4-16	34.5	53.5	35	24
14÷16	5/8	A112002/16	7/8-14	39.5	60.5	38,5	30
18-20	3/4	A112002/20	1" 1/16-12	45	68	42,5	36
22	7/8	A112002/22	1" 3/16-12	47	69	42,5	38
25	1"	A112002/25	1" 5/16-12	49	71	42,5	41
30-32	1" 1/4	A112002/32	1" 5/8-12	55	79	44	50
38	1" 1/2	A112002/38	1" 7/8-12	59	87	44	55

112002

Giunzione a "T" passaparatia
maschi JIC cono 37°
Bulkhead branch tee male JIC

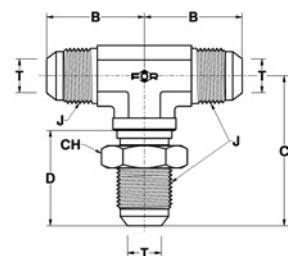

RACCORDI PER TUBI SVASATI - 37°

37° - FLARED TUBE CONNECTORS

113003

Giunzione a "L" maschi
JIC cono 37° - femmina
JIC cono 37°
Swivel nut run tee male
JIC - female JIC

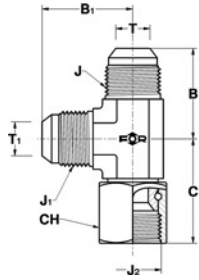

T		T1		RIFERIMENTO REFERENCE	J	J2	J1	B	C	B1	CH
MM.	IN.	MM.	IN.		UNF-UN	UNF-UN	UNF-UN				
6	1/4	6	1/4	A113003/06	7/16-20	7/16-20	7/16-20	22,5	26,5	22,5	14
8	5/16	8	5/16	A113003/08	1/2-20	1/2-20	1/2-20	24	29	24	17
10	3/8	10	3/8	A113003/10	9/16-18	9/16-18	9/16-18	27	32	27	17
12	1/2	12	1/2	A113003/12	3/4-16	3/4-16	3/4-16	31,5	35,5	31,5	22
14÷16	5/8	14÷16	5/8	A113003/16	7/8-14	7/8-14	7/8-14	36,5	42	36,5	27
18-20	3/4	18-20	3/4	A113003/20	1" 1/16-12	1" 1/16-12	1" 1/16-12	42	45,5	42	32
22	7/8	22	7/8	A113003/22	1" 3/16-12	1" 3/16-12	1" 3/16-12	44	46,5	44	36
25	1"	25	1"	A113003/25	1" 5/16-12	1" 5/16-12	1" 5/16-12	46	51,5	46	38
30-32	1" 1/4	30-32	1" 1/4	A113003/32	1" 5/8-12	1" 5/8-12	1" 5/8-12	52	59,5	52	50
38	1" 1/2	38	1" 1/2	A113003/38	1" 7/8-12	1" 7/8-12	1" 7/8-12	59	67	59	57
6	1/4	10	3/8	SA113003/060610	7/16-20	7/16-20	9/16-18	27	29	27	14
6	1/4	6	1/4	SA113003/061006	7/16-20	9/16-18	7/16-20	27	32	27	17
8	5/16	6	1/4	SA113003/080806	1/2-20	1/2-20	7/16-20	24	29	24	17
8	5/16	8	5/16	SA113003/081008	1/2-20	9/16-18	1/2-20	27	32	27	17
10	3/8	6	1/4	SA113003/101006	9/16-18	9/16-18	7/16-20	27	32	27	17
10	3/8	6	1/4	SA113003/101206	9/16-18	3/4-16	7/16-20	29	35,5	29	22
10	3/8	12	1/2	SA113003/101212	9/16-18	3/4-16	3/4-16	29	35,5	31,5	22
10	3/8	18-20	3/4	SA113003/102020	9/16-18	1" 1/16-12	1" 1/16-12	34	45,5	42	32
12	1/2	6	1/4	SA113003/121206	3/4-16	3/4-16	7/16-20	31,5	35,5	29	22
12	1/2	10	3/8	SA113003/121210	3/4-16	3/4-16	9/16-18	31,5	35,5	29	22
12	1/2	25	1"	SA113003/121225	3/4-16	3/4-16	1" 5/16-12	39,5	44,5	46	22
14÷16	5/8	10	3/8	SA113003/161610	7/8-14	7/8-14	9/16-18	36,5	42	31	27
14÷16	5/8	12	1/2	SA113003/161612	7/8-14	7/8-14	3/4-16	36,5	42	34	27
14÷16	5/8	18-20	3/4	SA113003/161620	7/8-14	7/8-14	1" 1/16-12	40	44	42	27
14÷16	5/8	14÷16	5/8	SA113003/162016	7/8-14	1" 1/16-12	7/8-14	39,5	45,5	39,5	32
14÷16	5/8	25	1"	SA113003/162525	7/8-14	1" 5/16-12	1" 5/16-12	42,5	51,5	46	38
18-20	3/4	12	1/2	SA113003/201212	1" 1/16-12	3/4-16	3/4-16	42	41	36,5	22
18-20	3/4	18-20	3/4	SA113003/201620	1" 1/16-12	7/8-14	1" 1/16-12	42	44	42	27
18-20	3/4	6	1/4	SA113003/202006	1" 1/16-12	1" 1/16-12	7/16-20	42	45,5	34	32
18-20	3/4	12	1/2	SA113003/202012	1" 1/16-12	1" 1/16-12	3/4-16	42	45,5	36,5	32
18-20	3/4	14÷16	5/8	SA113003/202016	1" 1/16-12	1" 1/16-12	7/8-14	42	45,5	39,5	32
18-20	3/4	25	1"	SA113003/202025	1" 1/16-12	1" 1/16-12	1" 5/16-12	44,5	49	46	32
18-20	3/4	18-20	3/4	SA113003/202520	1" 1/16-12	1" 5/16-12	1" 1/16-12	45	51,5	45	38
25	1"	10	3/8	SA113003/252510	1" 5/16-12	1" 5/16-12	9/16-18	46	51,5	37	38
25	1"	14÷16	5/8	SA113003/252516	1" 5/16-12	1" 5/16-12	7/8-14	46	51,5	42	38
25	1"	18-20	3/4	SA113003/252520	1" 5/16-12	1" 5/16-12	1" 1/16-12	46	51,5	44,5	38
30-32	1" 1/4	18-20	3/4	SA113003/323220	1" 5/8-12	1" 5/8-12	1" 1/16-12	52	59,5	49,5	50
30-32	1" 1/4	25	1"	SA113003/323225	1" 5/8-12	1" 5/8-12	1" 5/16-12	52	59,5	52	50
30-32	1" 1/4	38	1" 1/2	SA113003/323238	1" 5/8-12	1" 5/8-12	1" 7/8-12	56	61,5	59	50
38	1" 1/2	30-32	1" 1/4	SA113003/383232	1" 7/8-12	1" 5/8-12	1" 5/8-12	59	61,5	56	50
38	1" 1/2	25	1"	SA113003/383825	1" 7/8-12	1" 7/8-12	1" 5/16-12	59	67	54,5	57



T		T ₁		RIFERIMENTO REFERENCE	J	F	J ₁	B	C	B ₁	CH
MM.	IN.	MM.	IN.		UNF-UN	UNF-UN	UNF-UN				
6	1/4	6	1/4	A113014/0611	7/16-20	7/16-20	7/16-20	22.5	27.5	22.5	14
6	1/4	6	1/4	A113014/0612	7/16-20	1/2-20	7/16-20	24	27.5	24	17
6	1/4	6	1/4	A113014/0614	7/16-20	9/16-18	7/16-20	27	31.5	27	17
8	5/16	8	5/16	A113014/0812	1/2-20	1/2-20	1/2-20	24	27.5	24	17
10	3/8	10	3/8	A113014/1014	9/16-18	9/16-18	9/16-18	27	31.5	27	17
10	3/8	10	3/8	A113014/1019	9/16-18	3/4-16	9/16-18	28.5	36.5	28.5	22
12	1/2	12	1/2	A113014/1219	3/4-16	3/4-16	3/4-16	31.5	36.5	31.5	22
12	1/2	12	1/2	A113014/1222	3/4-16	7/8-14	3/4-16	34	43	34	27
12	1/2	12	1/2	A113014/1227	3/4-16	1" 1/16-12	3/4-16	37	49	37	32
14÷16	5/8	14÷16	5/8	A113014/1619	7/8-14	3/4-16	7/8-14	36.5	39.5	36.5	22
14÷16	5/8	14÷16	5/8	A113014/1622	7/8-14	7/8-14	7/8-14	36.5	43	36.5	27
14÷16	5/8	14÷16	5/8	A113014/1627	7/8-14	1" 1/16-12	7/8-14	39.5	49	39.5	32
18-20	3/4	18-20	3/4	A113014/2019	1" 1/16-12	3/4-16	1" 1/16-12	42	42	42	22
18-20	3/4	18-20	3/4	A113014/2022	1" 1/16-12	7/8-14	1" 1/16-12	42	45.5	42	27
18-20	3/4	18-20	3/4	A113014/2027	1" 1/16-12	1" 1/16-12	1" 1/16-12	42	49	42	32
18-20	3/4	18-20	3/4	A113014/2033	1" 1/16-12	1" 5/16-12	1" 1/16-12	44.5	52	44.5	38
22	7/8	22	7/8	A113014/2230	1" 3/16-12	1" 3/16-12	1" 3/16-12	44	50.5	44	35
25	1"	25	1"	A113014/2527	1" 5/16-12	1" 1/16-12	1" 5/16-12	46	52	46	32
25	1"	25	1"	A113014/2533	1" 5/16-12	1" 5/16-12	1" 5/16-12	46	52	46	38
25	1"	25	1"	A113014/2541	1" 5/16-12	1" 5/8-12	1" 5/16-12	51	57	51	50
30-32	1" 1/4	30-32	1" 1/4	A113014/3241	1" 5/8-12	1" 5/8-12	1" 5/8-12	52	57	52	50
38	1" 1/2	38	1" 1/2	A113014/3848	1" 7/8-12	1" 7/8-12	1" 7/8-12	59	61	59	55
10	3/8	6	1/4	SA113014/101906	9/16-18	3/4-16	7/16-20	28.5	36.5	28.5	22
10	3/8	12	1/2	SA113014/101912	9/16-18	3/4-16	3/4-16	29	36.5	31.5	22
12	1/2	12	1/2	SA113014/121412	3/4-16	9/16-18	3/4-16	31.5	33.5	31.5	17
12	1/2	6	1/4	SA113014/121906	3/4-16	3/4-16	7/16-20	31.5	36.5	29	22
14÷16	5/8	6	1/4	SA113014/162206	7/8-14	7/8-14	7/16-20	36.5	43	31	27
14÷16	5/8	14÷16	5/8	SA113014/163316	7/8-14	1" 5/16-12	7/8-14	42	52	42	38
18-20	3/4	12	1/2	SA113014/202212	1" 1/16-12	7/8-14	3/4-16	42	45.5	36.5	27
18-20	3/4	10	3/8	SA113014/202710	1" 1/16-12	1" 1/16-12	9/16-18	42	49	34	32
25	1"	12	1/2	SA113014/252712	1" 5/16-12	1" 1/16-12	3/4-16	46	52.5	39.5	32

113014

Terminale orientabile a "L"
JIC cono 37° - SAE UNF-UN
per sedi ISO 11926
Run (ADJ) tee male
JIC - male SAE UNF-UN
with O.R. ISO 11926 ports

SEDI PAG.30 / PORTS PAG.30

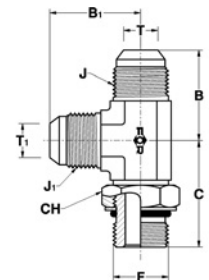

RACCORDI PER TUBI SVASATI - 37°

37° - FLARED TUBE CONNECTORS

113025

Terminale orientabile a "L"
 JIC cono 37° - GAS cil. (BSPP)
 con O.R. e rondella
 per sedi ISO 1179
Run (ADJ) tee male
JIC - male BSPP
with O.R. and retaining ring
ISO 1179 ports

SEDI PAG.32 / PORTS PAG.32

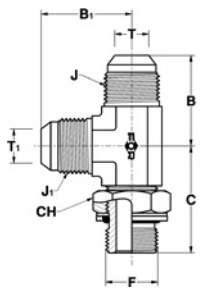

T		T ₁		RIFERIMENTO REFERENCE	J	F	J ₁	B	C	B ₁	CH
MM.	IN.	MM.	IN.		UNF-UN	GAS CIL-BSPP	UNF-UN				
6	1/4	6	1/4	A113025/0610	7/16-20	1/8	7/16-20	22,5	28	22,5	14
6	1/4	6	1/4	A113025/0613	7/16-20	1/4	7/16-20	27	31.5	27	19
6	1/4	6	1/4	A113025/0617	7/16-20	3/8	7/16-20	28.5	36.5	28.5	22
6	1/4	6	1/4	A113025/0621	7/16-20	1/2	7/16-20	31	43	31	27
8	5/16	8	5/16	A113025/0810	1/2-20	1/8	1/2-20	24	27.5	24	14
8	5/16	8	5/16	A113025/0813	1/2-20	1/4	1/2-20	27	31.5	27	19
8	5/16	8	5/16	A113025/0817	1/2-20	3/8	1/2-20	28.5	36.5	28.5	22
10	3/8	10	3/8	A113025/1013	9/16-18	1/4	9/16-18	27	31.5	27	19
10	3/8	10	3/8	A113025/1017	9/16-18	3/8	9/16-18	28.5	36.5	28.5	22
10	3/8	10	3/8	A113025/1021	9/16-18	1/2	9/16-18	31	43	31	27
12	1/2	12	1/2	A113025/1213	3/4-16	1/4	3/4-16	31.5	33.5	31.5	19
12	1/2	12	1/2	A113025/1217	3/4-16	3/8	3/4-16	31.5	36.5	31.5	22
12	1/2	12	1/2	A113025/1221	3/4-16	1/2	3/4-16	34	43	34	27
12	1/2	12	1/2	A113025/1226	3/4-16	3/4	3/4-16	37	49	37	36
14÷16	5/8	14÷16	5/8	A113025/1617	7/8-14	3/8	7/8-14	36.5	39.5	36.5	22
14÷16	5/8	14÷16	5/8	A113025/1621	7/8-14	1/2	7/8-14	36.5	43	36.5	27
14÷16	5/8	14÷16	5/8	A113025/1626	7/8-14	3/4	7/8-14	39.5	49	39.5	36
18-20	3/4	18-20	3/4	A113025/2021	1"1/16-12	1/2	1"1/16-12	42	45.5	42	27
18-20	3/4	18-20	3/4	A113025/2026	1"1/16-12	3/4	1"1/16-12	42	49	42	36
18-20	3/4	18-20	3/4	A113025/2033	1"1/16-12	1"	1"1/16-12	44.5	52	44.5	41
22	7/8	22	7/8	A113025/2226	1"3/16-12	3/4	1"3/16-12	44	50.5	44	36
25	1"	25	1"	A113025/2526	1"5/16-12	3/4	1"5/16-12	46	52	46	36
25	1"	25	1"	A113025/2533	1"5/16-12	1"	1"5/16-12	46	52	46	41
25	1"	25	1"	A113025/2542	1"5/16-12	1"1/4	1"5/16-12	51	57	51	50
30-32	1"1/4	30-32	1"1/4	A113025/3233	1"5/8-12	1"	1"5/8-12	52	57	52	41
30-32	1"1/4	30-32	1"1/4	A113025/3242	1"5/8-12	1"1/4	1"5/8-12	52	57	52	50
38	1"1/2	38	1"1/2	A113025/3842	1"7/8-12	1"1/4	1"7/8-12	59	59.5	59	50
38	1"1/2	38	1"1/2	A113025/3848	1"7/8-12	1"1/2	1"7/8-12	59	61	59	60
6	1/4	10	3/8	SA113025/061310	7/16-20	1/4	9/16-18	27	31.5	27	19
6	1/4	10	3/8	SA113025/062110	7/16-20	1/2	9/16-18	31	43	31	27
8	5/16	8	5/16	SA113025/082108	1/2-20	1/2	1/2-20	31	43	31	27
10	3/8	10	3/8	SA113025/101010	9/16-18	1/8	9/16-18	27	29.5	27	14
10	3/8	12	1/2	SA113025/101712	9/16-18	3/8	3/4-16	29	36.5	31.5	22
10	3/8	6	1/4	SA113025/102106	9/16-18	1/2	7/16-20	31	43	31	27
10	3/8	10	3/8	SA113025/103310	9/16-18	1"	9/16-18	37	52	37	41
14÷16	5/8	14÷16	5/8	SA113025/161316	7/8-14	1/4	7/8-14	36.5	37	36.5	19
14÷16	5/8	18-20	3/4	SA113025/162120	7/8-14	1/2	1"1/16-12	39.5	45.5	42	27
14÷16	5/8	12	1/2	SA113025/162612	7/8-14	3/4	3/4-16	39.5	49	36.5	36
14÷16	5/8	14÷16	5/8	SA113025/163316	7/8-14	1"	7/8-14	42.5	52	42.5	41
14÷16	5/8	18-20	3/4	SA113025/163320	7/8-14	1"	1"1/16-12	42.5	52	44	41
18-20	3/4	22	7/8	SA113025/202622	1"1/16-12	3/4	1"3/16-12	43.5	50.5	44	36
18-20	3/4	18-20	3/4	SA113025/204220	1"1/16-12	1"1/4	1"1/16-12	49.5	57.5	49.5	50
18-20	3/4	38	1"1/2	SA113025/204838	1"1/16-12	1"1/2	1"7/8-12	53.5	61	59	60
22	7/8	14÷16	5/8	SA113025/222616	1"3/16-12	3/4	7/8-14	44	50.5	41	36
25	1"	12	1/2	SA113025/252612	1"5/16-12	3/4	3/4-16	46	52	39.5	36
25	1"	18-20	3/4	SA113025/253320	1"5/16-12	1"	1"1/16-12	46	52	44	41
25	1"	14÷16	5/8	SA113025/254216	1"5/16-12	1"1/4	7/8-14	50.5	57	47	50
38	1"1/2	25	1"	SA113025/384225	1"7/8-12	1"1/4	1"5/16-12	59	59.5	54.5	50
38	1"1/2	25	1"	SA113025/384825	1"7/8-12	1"1/2	1"5/16-12	59	61	54.5	60

FOR S.P.A. - NORME E DIMENSIONI SOGGETTE A MODIFICHE SENZA PREAVVISO.
 FOR S.P.A. - DESIGN DETAILS AND SPECIFICATIONS SUBJECT TO CHANGE WITHOUT PRIOR NOTICE.



T		T ₁		RIFERIMENTO REFERENCE	J	F	J ₁	B	C	B ₁	CH
MM.	IN.	MM.	IN.		UNF-UN	GAS CIL./JIS	UNF-UN				
6	1/4	6	1/4	A113135/0610	7/16-20	1/8	7/16-20	22,5	28	22,5	14
6	1/4	6	1/4	A113135/0613	7/16-20	1/4	7/16-20	27	31,5	27	19
6	1/4	6	1/4	A113135/0617	7/16-20	3/8	7/16-20	28,5	36,5	28,5	22
6	1/4	6	1/4	A113135/0621	7/16-20	1/2	7/16-20	31	43	31	27
8	5/16	8	5/16	A113135/0810	1/2-20	1/8	1/2-20	24	27,5	24	14
8	5/16	8	5/16	A113135/0813	1/2-20	1/4	1/2-20	27	31,5	27	19
8	5/16	8	5/16	A113135/0817	1/2-20	3/8	1/2-20	28,5	36,5	28,5	22
10	3/8	10	3/8	A113135/1013	9/16-18	1/4	9/16-18	27	31,5	27	19
10	3/8	10	3/8	A113135/1017	9/16-18	3/8	9/16-18	28,5	36,5	28,5	22
10	3/8	10	3/8	A113135/1021	9/16-18	1/2	9/16-18	31	43	31	27
12	1/2	12	1/2	A113135/1213	3/4-16	1/4	3/4-16	31,5	33,5	31,5	19
12	1/2	12	1/2	A113135/1217	3/4-16	3/8	3/4-16	31,5	36,5	31,5	22
12	1/2	12	1/2	A113135/1221	3/4-16	1/2	3/4-16	34	43	34	27
12	1/2	12	1/2	A113135/1226	3/4-16	3/4	3/4-16	37	49	37	36
14÷16	5/8	14÷16	5/8	A113135/1617	7/8-14	3/8	7/8-14	36,5	39,5	36,5	22
14÷16	5/8	14÷16	5/8	A113135/1621	7/8-14	1/2	7/8-14	36,5	43	36,5	27
14÷16	5/8	14÷16	5/8	A113135/1626	7/8-14	3/4	7/8-14	39,5	49	39,5	36
18-20	3/4	18-20	3/4	A113135/2021	1" 1/16-12	1/2	1" 1/16-12	42	45,5	42	27
18-20	3/4	18-20	3/4	A113135/2026	1" 1/16-12	3/4	1" 1/16-12	42	49	42	36
18-20	3/4	18-20	3/4	A113135/2033	1" 1/16-12	1"	1" 1/16-12	44,5	52	44,5	41
22	7/8	22	7/8	A113135/2226	1" 3/16-12	3/4	1" 3/16-12	44	50,5	44	36
25	1"	25	1"	A113135/2526	1" 5/16-12	3/4	1" 5/16-12	46	52	46	36
25	1"	25	1"	A113135/2533	1" 5/16-12	1"	1" 5/16-12	46	52	46	41
25	1"	25	1"	A113135/2542	1" 5/16-12	1" 1/4	1" 5/16-12	51	57	51	50
30-32	1" 1/4	30-32	1" 1/4	A113135/3233	1" 5/8-12	1"	1" 5/8-12	52	57	52	41
30-32	1" 1/4	30-32	1" 1/4	A113135/3242	1" 5/8-12	1" 1/4	1" 5/8-12	52	57	52	50
38	1" 1/2	38	1" 1/2	A113135/3842	1" 7/8-12	1" 1/4	1" 7/8-12	59	59,5	59	50
38	1" 1/2	38	1" 1/2	A113135/3848	1" 7/8-12	1" 1/2	1" 7/8-12	59	61	59	55
6	1/4	10	3/8	A113135/061310	7/16-20	1/4	9/16-18	27	31,5	27	19
6	1/4	10	3/8	A113135/062110	7/16-20	1/2	9/16-18	31	43	31	27
8	5/16	8	5/16	A113135/082108	1/2-20	1/2	1/2-20	31	43	31	27
10	3/8	10	3/8	A113135/101010	9/16-18	1/8	9/16-18	27	29,5	27	14
10	3/8	12	1/2	A113135/101712	9/16-18	3/8	3/4-16	29	36,5	31,5	22
10	3/8	6	1/4	A113135/102106	9/16-18	1/2	7/16-20	31	43	31	27
10	3/8	10	3/8	A113135/103310	9/16-18	1"	9/16-18	37	52	37	41
14÷16	5/8	14÷16	5/8	A113135/161316	7/8-14	1/4	7/8-14	36,5	37	36,5	19
14÷16	5/8	18-20	3/4	A113135/162120	7/8-14	1/2	1" 1/16-12	39,5	45,5	42	27
14÷16	5/8	12	1/2	A113135/162612	7/8-14	3/4	3/4-16	39,5	49	36,5	36
14÷16	5/8	14÷16	5/8	A113135/163316	7/8-14	1"	7/8-14	42,5	52	42,5	41
14÷16	5/8	18-20	3/4	A113135/163320	7/8-14	1"	1" 1/16-12	42,5	52	44	41
18-20	3/4	22	7/8	A113135/202622	1" 1/16-12	3/4	1" 3/16-12	43,5	50,5	44	36
18-20	3/4	18-20	3/4	A113135/204220	1" 1/16-12	1" 1/4	1" 1/16-12	49,5	57,5	49,5	50
18-20	3/4	38	1" 1/2	A113135/204838	1" 1/16-12	1" 1/2	1" 7/8-12	53,5	61	59	55
22	7/8	14÷16	5/8	A113135/222616	1" 3/16-12	3/4	7/8-14	44	50,5	41	36
25	1"	12	1/2	A113135/252612	1" 5/16-12	3/4	3/4-16	46	52	39,5	36
25	1"	18-20	3/4	A113135/253320	1" 5/16-12	1"	1" 1/16-12	46	52	44	41
25	1"	14÷16	5/8	A113135/254216	1" 5/16-12	1" 1/4	7/8-14	50,5	57	47	50
38	1" 1/2	25	1"	A113135/384225	1" 7/8-12	1" 1/4	1" 5/16-12	59	59,5	54,5	50
38	1" 1/2	25	1"	A113135/384825	1" 7/8-12	1" 1/2	1" 5/16-12	59	61	54,5	55

113135

Terminale orientabile ad "L"
JIC cono 37° - GAS cil. (JIS)
con O.R. per sedi JIS 2351
Run (ADJ) tee male
JIC - male JIS
with O.R. JIS 2351 ports
SEDI PAG.31 / PORTS PAG.31

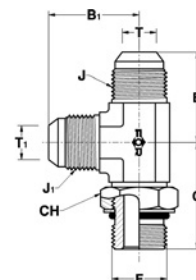

RACCORDI PER TUBI SVASATI - 37°

37° - FLARED TUBE CONNECTORS

113036

Terminale orientabile a "L"
 JIC cono 37° - Metrico cil.
 con O.R. e rondella
 per sedi ISO 9974
 Run (ADJ) tee male
 JIC - male Metric
 with O.R. and retaining ring
 ISO 9974 ports

SEDI PAG.32 / PORTS PAG.32

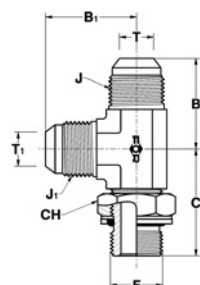

T		T ₁		RIFERIMENTO REFERENCE	J	F	J ₁	B	C	B ₁	CH
MM.	IN.	MM.	IN.		UNF-UN	METRICO METRIC	UNF-UN				
6	1/4	6	1/4	A113036/0610	7/16-20	10x1	7/16-20	22,5	27,5	22,5	14
6	1/4	6	1/4	A113036/0612	7/16-20	12x1,5	7/16-20	27	31,5	27	17
8	5/16	8	5/16	A113036/0810	1/2-20	10x1	1/2-20	24	27,5	24	14
8	5/16	8	5/16	A113036/0812	1/2-20	12x1,5	1/2-20	27	31,5	27	17
8	5/16	8	5/16	A113036/0814	1/2-20	14x1,5	1/2-20	27	32,5	27	19
10	3/8	10	3/8	A113036/1014	9/16-18	14x1,5	9/16-18	27	32,5	27	19
10	3/8	10	3/8	A113036/1016	9/16-18	16x1,5	9/16-18	28,5	36,5	28,5	22
12	1/2	12	1/2	A113036/1216	3/4-16	16x1,5	3/4-16	31,5	36,5	31,5	22
12	1/2	12	1/2	A113036/1218	3/4-16	18x1,5	3/4-16	31,5	39,5	31,5	24
14÷16	5/8	14÷16	5/8	A113036/1618	7/8-14	18x1,5	7/8-14	36,5	41,5	36,5	24
14÷16	5/8	14÷16	5/8	A113036/1620	7/8-14	20x1,5	7/8-14	36,5	43	36,5	27
14÷16	5/8	14÷16	5/8	A113036/1622	7/8-14	22x1,5	7/8-14	36,5	43	36,5	27
18-20	3/4	18-20	3/4	A113036/2022	1" 1/16-12	22x1,5	1" 1/16-12	42	45,5	42	27
18-20	3/4	18-20	3/4	A113036/2027	1" 1/16-12	27x2	1" 1/16-12	42	51,5	42	32
22	7/8	22	7/8	A113036/2226	1" 3/16-12	26x1,5	1" 3/16-12	44	50,5	44	36
25	1"	25	1"	A113036/2527	1" 5/16-12	27x2	1" 5/16-12	46	55	46	32
25	1"	25	1"	A113036/2533	1" 5/16-12	33x2	1" 5/16-12	46	55	46	41
30-32	1" 1/4	30-32	1" 1/4	A113036/3242	1" 5/8-12	42x2	1" 5/8-12	52	60	52	50
38	1" 1/2	38	1" 1/2	A113036/3848	1" 7/8-12	48x2	1" 7/8-12	59	67	59	55
6	1/4	6	1/4	SA113036/061406	7/16-20	14x1,5	7/16-20	27	32,5	27	19
6	1/4	12	1/2	SA113036/061812	7/16-20	18x1,5	3/4-16	29	39,5	31,5	24
8	5/16	12	1/2	SA113036/081812	1/2-20	18x1,5	3/4-16	29	39,5	31,5	24
10	3/8	10	3/8	SA113036/101810	9/16-18	18x1,5	9/16-18	29	39,5	29	24
10	3/8	14÷16	5/8	SA113036/102216	9/16-18	22x1,5	7/8-14	31,50	43	36,5	27
10	3/8	18-20	3/4	SA113036/102220	9/16-18	22x1,5	1" 1/16-12	34	45,5	42	27
12	1/2	8	5/16	SA113036/121808	3/4-16	18x1,5	1/2-20	31,5	39,5	29	24
12	1/2	14÷16	5/8	SA113036/121816	3/4-16	18x1,5	7/8-14	33,5	41,5	36,5	24
14÷16	5/8	12	1/2	SA113036/161812	7/8-14	18x1,5	3/4-16	36,5	41,5	33,5	24
14÷16	5/8	14÷16	5/8	SA113036/162616	7/8-14	26x1,5	7/8-14	39,5	49	39,5	36
18-20	3/4	18-20	3/4	SA113036/201820	1" 1/16-12	18x1,5	1" 1/16-12	42	47	42	24
18-20	3/4	25	1"	SA113036/202625	1" 1/16-12	26x1,5	1" 5/16-12	45	52,5	44	36
25	1"	12	1/2	SA113036/251812	1" 5/16-12	18x1,5	3/4-16	46	47	39,5	24



T		T ₁		RIFERIMENTO REFERENCE	J	F	J ₁	B	C	B ₁	CH
MM.	IN.	MM.	IN.								
6	1/4	6	1/4	A113113/0610	7/16-20	10x1	7/16-20	22,5	27,5	22,5	14
6	1/4	6	1/4	A113113/0612	7/16-20	12x1,5	7/16-20	27	31,5	27	17
8	5/16	8	5/16	A113113/0810	1/2-20	10x1	1/2-20	24	27,5	24	14
8	5/16	8	5/16	A113113/0812	1/2-20	12x1,5	1/2-20	27	31,5	27	17
8	5/16	8	5/16	A113113/0814	1/2-20	14x1,5	1/2-20	27	32,5	27	19
10	3/8	10	3/8	A113113/1014	9/16-18	14x1,5	9/16-18	27	32,5	27	19
10	3/8	10	3/8	A113113/1016	9/16-18	16x1,5	9/16-18	28,5	36,5	28,5	22
12	1/2	12	1/2	A113113/1216	3/4-16	16x1,5	3/4-16	31,5	36,5	31,5	22
12	1/2	12	1/2	A113113/1218	3/4-16	18x1,5	3/4-16	31,5	39,5	31,5	24
14÷16	5/8	14÷16	5/8	A113113/1618	7/8-14	18x1,5	7/8-14	36,5	41,5	36,5	24
14÷16	5/8	14÷16	5/8	A113113/1622	7/8-14	22x1,5	7/8-14	36,5	43	36,5	27
18-20	3/4	18-20	3/4	A113113/2022	1" 1/16-12	22x1,5	1" 1/16-12	42	45,5	42	27
18-20	3/4	18-20	3/4	A113113/2027	1" 1/16-12	27x2	1" 1/16-12	42	51,5	42	32
25	1"	25	1"	A113113/2527	1" 5/16-12	27x2	1" 5/16-12	46	55	46	32
25	1"	25	1"	A113113/2533	1" 5/16-12	33x2	1" 5/16-12	46	55	46	41
30-32	1" 1/4	30-32	1" 1/4	A113113/3242	1" 5/8-12	42x2	1" 5/8-12	52	60	52	50
38	1" 1/2	38	1" 1/2	A113113/3848	1" 7/8-12	48x2	1" 7/8-12	59	67	59	55
12	1/2	14÷16	5/8	SA113113/121816	3/4-16	18x1,5	7/8-14	33,5	41,5	36,5	24
14÷16	5/8	12	1/2	SA113113/161812	7/8-14	18x1,5	3/4-16	36,5	41,5	33,5	24
25	1"	12	1/2	SA113113/251812	1" 5/16-12	18x1,5	3/4-16	46	47	39,5	24

113113

Terminale orientabile ad "L"
JIC cono 37° - Metrico cil. con O.R.
per sedi ISO 6149
Run (ADJ) tee male
JIC - male Metric
with O.R. ISO 6149

SEDI PAG.30 / PORTS PAG.30

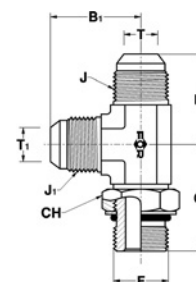

RACCORDI PER TUBI SVASATI - 37°

37° - FLARED TUBE CONNECTORS

113047

Terminale a "L"
 JIC cono 37° - NPTF
 per sedi SAE 476
 Run tee male
 JIC - male NPTF
 taper SAE 476 ports

SEDI PAG.35 / PORTS PAG.35

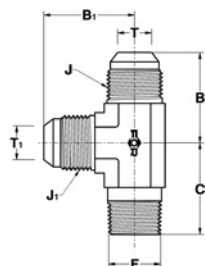

T		T ₁		RIFERIMENTO REFERENCE	J	F	J ₁	B	C	B ₁
MM.	IN.	MM.	IN.		UNF-UN	NPTF	UNF-UN			
6	1/4	6	1/4	A113047/0610	7/16-20	1/8	7/16-20	22.5	19.5	22.5
6	1/4	6	1/4	A113047/0613	7/16-20	1/4	7/16-20	27	27.5	27
8	5/16	8	5/16	A113047/0810	1/2-20	1/8	1/2-20	24	19.5	24
8	5/16	8	5/16	A113047/0813	1/2-20	1/4	1/2-20	27	27.5	27
10	3/8	10	3/8	A113047/1010	9/16-18	1/8	9/16-18	27	23.5	27
10	3/8	10	3/8	A113047/1013	9/16-18	1/4	9/16-18	27	27.5	27
10	3/8	10	3/8	A113047/1017	9/16-18	3/8	9/16-18	28.5	31	28.5
10	3/8	10	3/8	A113047/1021	9/16-18	1/2	9/16-18	31	37	31
12	1/2	12	1/2	A113047/1213	3/4-16	1/4	3/4-16	31.5	31	31.5
12	1/2	12	1/2	A113047/1217	3/4-16	3/8	3/4-16	31.5	31	31.5
12	1/2	12	1/2	A113047/1221	3/4-16	1/2	3/4-16	34	37	34
12	1/2	12	1/2	A113047/1226	3/4-16	3/4	3/4-16	37	40.5	37
14÷16	5/8	14÷16	5/8	A113047/1617	7/8-14	3/8	7/8-14	36.5	32	36.5
14÷16	5/8	14÷16	5/8	A113047/1621	7/8-14	1/2	7/8-14	36.5	37	36.5
14÷16	5/8	14÷16	5/8	A113047/1626	7/8-14	3/4	7/8-14	39.5	40.5	39.5
18-20	3/4	18-20	3/4	A113047/2021	1"1/16-12	1/2	1"1/16-12	42	40.5	42
18-20	3/4	18-20	3/4	A113047/2026	1"1/16-12	3/4	1"1/16-12	42	40.5	42
22	7/8	22	7/8	A113047/2226	1"3/16-12	3/4	1"3/16-12	44	43	44
25	1"	25	1"	A113047/2526	1"5/16-12	3/4	1"5/16-12	46	45	46
25	1"	25	1"	A113047/2533	1"5/16-12	1"	1"5/16-12	46	50	46
30-32	1"1/4	30-32	1"1/4	A113047/3233	1"5/8-12	1"	1"5/8-12	52	59	52
30-32	1"1/4	30-32	1"1/4	A113047/3242	1"5/8-12	1"1/4	1"5/8-12	52	60	52
38	1"1/2	38	1"1/2	A113047/3848	1"7/8-12	1"1/2	1"7/8-12	59	67	59
25	1"	25	1"	SA113047/254225	1"5/16-12	1"1/4	1"5/16-12	50.5	60	50.5



T		T ₁		RIFERIMENTO REFERENCE	J	F	J ₁	B	C	B ₁
MM.	IN.	MM.	IN.		UNF-UN	GAS CON. BSPT	UNF-UN			
6	1/4	6	1/4	A113058/0610	7/16-20	1/8	7/16-20	22,5	20,5	22,5
6	1/4	6	1/4	A113058/0613	7/16-20	1/4	7/16-20	27	27,5	27
8	5/16	8	5/16	A113058/0810	1/2-20	1/8	1/2-20	24	19,5	24
8	5/16	8	5/16	A113058/0813	1/2-20	1/4	1/2-20	27	27,5	27
10	3/8	10	3/8	A113058/1013	9/16-18	1/4	9/16-18	27	27,5	27
10	3/8	10	3/8	A113058/1017	9/16-18	3/8	9/16-18	28,5	31	28,5
10	3/8	10	3/8	A113058/1021	9/16-18	1/2	9/16-18	31	37	31
12	1/2	12	1/2	A113058/1213	3/4-16	1/4	3/4-16	31,5	31	31,5
12	1/2	12	1/2	A113058/1217	3/4-16	3/8	3/4-16	31,5	31	31,5
12	1/2	12	1/2	A113058/1221	3/4-16	1/2	3/4-16	34	37	34
14÷16	5/8	14÷16	5/8	A113058/1617	7/8-14	3/8	7/8-14	36,5	32	36,5
14÷16	5/8	14÷16	5/8	A113058/1621	7/8-14	1/2	7/8-14	36,5	37	36,5
14÷16	5/8	14÷16	5/8	A113058/1626	7/8-14	3/4	7/8-14	39,5	40,5	39,5
18-20	3/4	18-20	3/4	A113058/2021	1" 1/16-12	1/2	1" 1/16-12	42	40,5	42
18-20	3/4	18-20	3/4	A113058/2026	1" 1/16-12	3/4	1" 1/16-12	42	40,5	42
18-20	3/4	18-20	3/4	A113058/2033	1" 1/16-12	1"	1" 1/16-12	45	50	45
22	7/8	22	7/8	A113058/2226	1" 3/16-12	3/4	1" 3/16-12	44	43	44
25	1"	25	1"	A113058/2526	1" 5/16-12	3/4	1" 5/16-12	46	44,5	46
25	1"	25	1"	A113058/2533	1" 5/16-12	1"	1" 5/16-12	46	50	46
30-32	1" 1/4	30-32	1" 1/4	A113058/3233	1" 5/8-12	1"	1" 5/8-12	52	59	52
30-32	1" 1/4	30-32	1" 1/4	A113058/3242	1" 5/8-12	1" 1/4	1" 5/8-12	52	60	52
38	1" 1/2	38	1" 1/2	A113058/3848	1" 7/8-12	1" 1/2	1" 7/8-12	59	67	59

113058

Terminale a "L"
JIC cono 37° - GAS conico (BSPT)
per sedi ISO 7
Run tee male
JIC - male BSPT
taper ISO 7 ports

SEDI PAG.35 / PORTS PAG.35

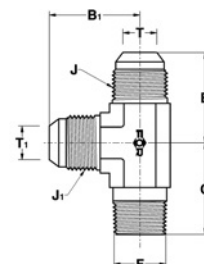

T		T ₁		RIFERIMENTO REFERENCE	J	F	J ₁	B	C	B ₁
MM.	IN.	MM.	IN.		UNF-UN	NPTF	UNF-UN			
6	1/4	6	1/4	A113070/0610	7/16-20	1/8	7/16-20	27	16,5	27
6	1/4	6	1/4	A113070/0613	7/16-20	1/4	7/16-20	31	22,5	31
8	5/16	8	5/16	A113070/0810	1/2-20	1/8	1/2-20	27	16,5	27
8	5/16	8	5/16	A113070/0813	1/2-20	1/4	1/2-20	31	22,5	31
10	3/8	10	3/8	A113070/1010	9/16-18	1/8	9/16-18	27	16,5	27
10	3/8	10	3/8	A113070/1013	9/16-18	1/4	9/16-18	31	22,5	31
10	3/8	10	3/8	A113070/1017	9/16-18	3/8	9/16-18	33	26	33
12	1/2	12	1/2	A113070/1213	3/4-16	1/4	3/4-16	32	22,5	32
12	1/2	12	1/2	A113070/1217	3/4-16	3/8	3/4-16	36	26	36
12	1/2	12	1/2	A113070/1221	3/4-16	1/2	3/4-16	39	31	39
14÷16	5/8	14÷16	5/8	A113070/1621	7/8-14	1/2	7/8-14	41,5	31	41,5
18-20	3/4	18-20	3/4	A113070/2021	1" 1/16-12	1/2	1" 1/16-12	42	31	42
18-20	3/4	18-20	3/4	A113070/2026	1" 1/16-12	3/4	1" 1/16-12	48	34,5	48
22	7/8	22	7/8	A113070/2226	1" 3/16-12	3/4	1" 3/16-12	47	36	47
25	1"	25	1"	A113070/2533	1" 5/16-12	1"	1" 5/16-12	55	41	55
30-32	1" 1/4	30-32	1" 1/4	A113070/3242	1" 5/8-12	1" 1/4	1" 5/8-12	59	43	59
38	1" 1/2	38	1" 1/2	A113070/3848	1" 7/8-12	1" 1/2	1" 7/8-12	73,5	52,5	73,5

113070

Giunzione a "L" maschi
JIC cono 37° - femmina NPTF
Run tee male
JIC - female NPTF

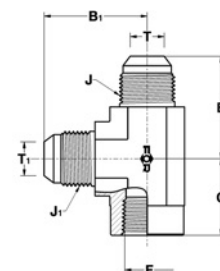

RACCORDI PER TUBI SVASATI - 37°

37° - FLARED TUBE CONNECTORS

113081

Giunzione a "L" maschi
 JIC cono 37° - femmina
 GAS cil. (BSPP)
 Run tee male
 JIC - female BSPP

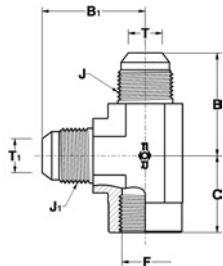

T		T ₁		RIFERIMENTO REFERENCE	J	F	J ₁	B	C	B ₁
MM.	IN.	MM.	IN.		UNF-UN	GAS CIL. JIS	UNF-UN			
6	1/4	6	1/4	A113081/0610	7/16-20	1/8	7/16-20	27	16.5	27
6	1/4	6	1/4	A113081/0613	7/16-20	1/4	7/16-20	31	22.5	31
6	1/4	6	1/4	A113081/0617	7/16-20	3/8	7/16-20	33	26	33
8	5/16	8	5/16	A113081/0810	1/2-20	1/8	1/2-20	27	16.5	27
8	5/16	8	5/16	A113081/0813	1/2-20	1/4	1/2-20	31	22.5	31
10	3/8	10	3/8	A113081/1013	9/16-18	1/4	9/16-18	31	22.5	31
10	3/8	10	3/8	A113081/1017	9/16-18	3/8	9/16-18	33	26	33
10	3/8	10	3/8	A113081/1021	9/16-18	1/2	9/16-18	36	31	36
12	1/2	12	1/2	A113081/1213	3/4-16	1/4	3/4-16	32	22.5	32
12	1/2	12	1/2	A113081/1217	3/4-16	3/8	3/4-16	36	26	36
12	1/2	12	1/2	A113081/1221	3/4-16	1/2	3/4-16	39	31	39
14÷16	5/8	14÷16	5/8	A113081/1621	7/8-14	1/2	7/8-14	41.5	31	41.5
18-20	3/4	18-20	3/4	A113081/2021	1" 1/16-12	1/2	1" 1/16-12	42	31	42
18-20	3/4	18-20	3/4	A113081/2026	1" 1/16-12	3/4	1" 1/16-12	48	34.5	48
22	7/8	22	7/8	A113081/2226	1" 3/16-12	3/4	1" 3/16-12	47	36	47
25	1"	25	1"	A113081/2533	1" 5/16-12	1"	1" 5/16-12	55	41	55
30-32	1" 1/4	30-32	1" 1/4	A113081/3233	1" 5/8-12	1"	1" 5/8-12	55	41	55
30-32	1" 1/4	30-32	1" 1/4	A113081/3242	1" 5/8-12	1" 1/4	1" 5/8-12	59	43	59
38	1" 1/2	38	1" 1/2	A113081/3842	1" 7/8-12	1" 1/4	1" 7/8-12	59	43	59
38	1" 1/2	38	1" 1/2	A113081/3848	1" 7/8-12	1" 1/2	1" 7/8-12	73,5	52,5	73,5



T		RIFERIMENTO REFERENCE	J	B	C	D	A	CH
MM.	IN.		<small>UNF-UN</small>					
6	1/4	A114004/06	7/16-20	24.5	40.5	28,5	65	17
8	5/16	A114004/08	1/2-20	26	41	28,5	67	19
10	3/8	A114004/10	9/16-18	27.5	46	30	73.5	22
12	1/2	A114004/12	3/4-16	34.5	53.5	35	88	24
14÷16	5/8	A114004/16	7/8-14	39.5	60.5	38,5	100	30
18-20	3/4	A114004/20	1" 1/16-12	45	68	42,5	113	36
22	7/8	A114004/22	1" 3/16-12	47	69	42,5	116	38
25	1"	A114004/25	1" 5/16-12	49	71	42,5	120	41
30-32	1" 1/4	A114004/32	1" 5/8-12	55	79	44	134	50
38	1" 1/2	A114004/38	1" 7/8-12	59	87	44	146	55

114004

Giunzione a "L" passaparatia
maschi JIC cono 37°
Bulkhead run tee male JIC

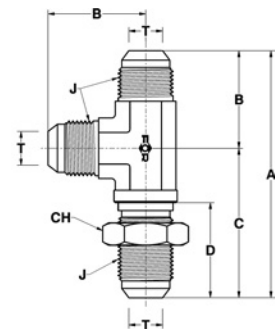

T		RIFERIMENTO REFERENCE	J	B	A
MM.	IN.		<small>UNF-UN</small>		
6	1/4	A115005/06	7/16-20	22,5	45
8	5/16	A115005/08	1/2-20	24	48
10	3/8	A115005/10	9/16-18	27	54
12	1/2	A115005/12	3/4-16	31.5	63
14÷16	5/8	A115005/16	7/8-14	36.5	73
18-20	3/4	A115005/20	1" 1/16-12	42	84
22	7/8	A115005/22	1" 3/16-12	44	88
25	1"	A115005/25	1" 5/16-12	46	92
30-32	1" 1/4	A115005/32	1" 5/8-12	52	104
38	1" 1/2	A115005/38	1" 7/8-12	59	118

115005

Giunzione a croce maschi
JIC cono 37°
Union cross male JIC

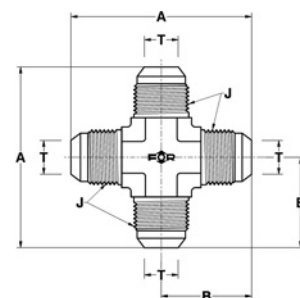

RACCORDI PER TUBI SVASATI - 37°

37° - FLARED TUBE CONNECTORS

402008

Flangia diritta maschio
JIC cono 37° - SAE 3000 PSI
Straight male
JIC - SAE 3000 PSI flange

SEDI PAG.40 / PORTS PAG.40

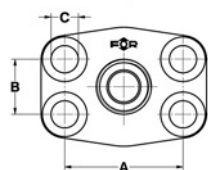
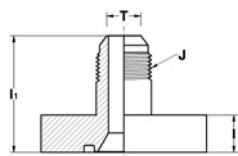

DN	T	RIFERIMENTO REFERENCE		J	I ₁	A	B	C	I
		SIZE	MM.						
1/2	12	1/2	A402008/1212	3/4-16	41	38,10	17,48	9	14
1/2	14÷16	5/8	A402008/1216	7/8-14	44	38,10	17,48	9	14
1/2	18-20	3/4	A402008/1220	1"1/16-12	46	38,10	17,48	9	14
3/4	14÷16	5/8	A402008/1916	7/8-14	47	47,63	22,23	11	15
3/4	18-20	3/4	A402008/1920	1"1/16-12	49	47,63	22,23	11	15
3/4	25	1"	A402008/1925	1"5/16-12	50	47,63	22,23	11	15
1"	18-20	3/4	A402008/2520	1"1/16-12	51	52,37	26,19	11	17
1"	25	1"	A402008/2525	1"5/16-12	52	52,37	26,19	11	17
1"	30-32	1"1/4	A402008/2532	1"5/8-12	54	52,37	26,19	11	17
1"1/4	25	1"	A402008/3225	1"5/16-12	56	58,72	30,18	11,5	21
1"1/4	30-32	1"1/4	A402008/3232	1"5/8-12	58	58,72	30,18	11,5	21
1"1/4	38	1"1/2	A402008/3238	1"7/8-12	61	58,72	30,18	11,5	21
1"1/2	30-32	1"1/4	A402008/3832	1"5/8-12	64	69,85	35,71	13,5	24
1"1/2	38	1"1/2	A402008/3838	1"7/8-12	67	69,85	35,71	13,5	24
1"1/2	25	1"	SA402008/3825	1"5/16-12	62,5	69,85	35,71	13,5	24

402503

Flangia diritta maschio
JIC cono 37° - SAE 6000 PSI
Straight male
JIC - SAE 6000 PSI flange

SEDI PAG.40 / PORTS PAG.40

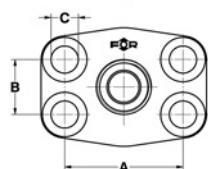
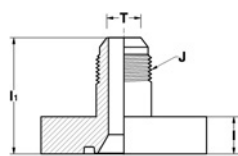

DN	T	RIFERIMENTO REFERENCE		J	I ₁	A	B	C	I
		SIZE	MM.						
1/2	12	1/2	A402503/1212	3/4-16	42	40,49	18,24	9	15
1/2	14÷16	5/8	A402503/1216	7/8-14	45	40,49	18,24	9	15
1/2	18-20	3/4	A402503/1220	1"1/16-12	47	40,49	18,24	9	15
3/4	14÷16	5/8	A402503/1916	7/8-14	49	50,80	23,80	11	17
3/4	18-20	3/4	A402503/1920	1"1/16-12	51	50,80	23,80	11	17
3/4	25	1"	A402503/1925	1"5/16-12	52	50,80	23,80	11	17
1"	18-20	3/4	A402503/2520	1"1/16-12	58	57,15	27,76	13	21
1"	25	1"	A402503/2525	1"5/16-12	59	57,15	27,76	13	21
1"	30-32	1"1/4	A402503/2532	1"5/8-12	61	57,15	27,76	13	21
1"1/4	25	1"	A402503/3225	1"5/16-12	64	66,68	31,75	15	24
1"1/4	30-32	1"1/4	A402503/3232	1"5/8-12	66	66,68	31,75	15	24
1"1/4	38	1"1/2	A402503/3238	1"7/8-12	69	66,68	31,75	15	24
1"1/2	30-32	1"1/4	A402503/3832	1"5/8-12	70	79,38	36,50	17	27
1"1/2	38	1"1/2	A402503/3838	1"7/8-12	73	79,38	36,50	17	27
1/2	10	3/8	SA402503/1210	9/16-18	39,5	40,49	18,24	9	15
3/4	30-32	1"1/4	SA402503/1932	1"5/8-12	54	50,80	23,80	11	17
1"1/2	25	1"	SA402503/3825	1"5/16-12	70	79,38	36,50	17	27



DN T			RIFERIMENTO REFERENCE	J	I ₁	I	A	B	C
SIZE	MM.	IN.							
1/2	12	1/2	A407035/1212	UNF-UN 3/4-16	40	17	38,10	17,48	9
1/2	14÷16	5/8	A407035/1216	7/8-14	42	17	38,10	17,48	9
1/2	18-20	3/4	A407035/1220	1"1/16-12	43	20	38,10	17,48	9
3/4	14÷16	5/8	A407035/1916	7/8-14	45	20	47,63	22,23	11
3/4	18-20	3/4	A407035/1920	1"1/16-12	47	20	47,63	22,23	11
3/4	25	1"	A407035/1925	1"5/16-12	48	25	47,63	22,23	11
1"	18-20	3/4	A407035/2520	1"1/16-12	50	20	52,37	26,19	11
1"	25	1"	A407035/2525	1"5/16-12	51	25	52,37	26,19	11
1"	30-32	1"1/4	A407035/2532	1"5/8-12	53	31	52,37	26,19	11
1"1/4	25	1"	A407035/3225	1"5/16-12	56	25	58,72	30,18	11,5
1"1/4	30-32	1"1/4	A407035/3232	1"5/8-12	58	31	58,72	30,18	11,5
1"1/4	38	1"1/2	A407035/3238	1"7/8-12	61	37	58,72	30,18	11,5
1"1/2	30-32	1"1/4	A407035/3832	1"5/8-12	63	31	69,85	35,71	13,5
1"1/2	38	1"1/2	A407035/3838	1"7/8-12	66	37	69,85	35,71	13,5
1"	12	1/2	SA407035/2512	3/4-16	46	20	52,37	26,19	11

407035

Flangia 90° maschio
JIC cono 37° - SAE 3000 PSI
90° male

JIC - SAE 3000 PSI flange

SEDI PAG.40 / PORTS PAG.40

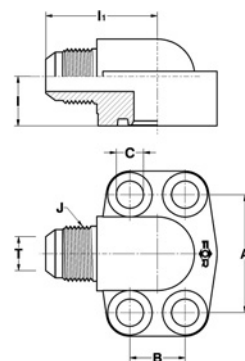

DN T			RIFERIMENTO REFERENCE	J	I ₁	I	A	B	C
SIZE	MM.	IN.							
1/2	12	1/2	A407530/1212	UNF-UN 3/4-16	40	17	40,49	18,24	9
1/2	14÷16	5/8	A407530/1216	7/8-14	42	17	40,49	18,24	9
1/2	18-20	3/4	A407530/1220	1"1/16-12	43	20	40,49	18,24	9
3/4	14÷16	5/8	A407530/1916	7/8-14	49	20	50,80	23,80	11
3/4	18-20	3/4	A407530/1920	1"1/16-12	51	20	50,80	23,80	11
3/4	25	1"	A407530/1925	1"5/16-12	52	25	50,80	23,80	11
1"	18-20	3/4	A407530/2520	1"1/16-12	55	25	57,15	27,76	13
1"	25	1"	A407530/2525	1"5/16-12	56	25	57,15	27,76	13
1"	30-32	1"1/4	A407530/2532	1"5/8-12	58	31	57,15	27,76	13
1"1/4	25	1"	A407530/3225	1"5/16-12	56	31	66,68	31,75	15
1"1/4	30-32	1"1/4	A407530/3232	1"5/8-12	63	31	66,68	31,75	15
1"1/4	38	1"1/2	A407530/3238	1"7/8-12	63	37	66,68	31,75	15
1"1/2	30-32	1"1/4	A407530/3832	1"5/8-12	67	37	79,38	36,50	17
1"1/2	38	1"1/2	A407530/3838	1"7/8-12	70	37	79,38	36,50	17
3/4	22	7/8	SA407530/1922	1"3/16-12	52	25	50,80	23,80	11
1"	12	1/2	SA407530/2512	3/4-16	56	25	57,15	27,76	13
1"	38	1"1/2	SA407530/2538	1"7/8-12	61	37	57,15	27,76	13

407530

Flangia 90° maschio
JIC cono 37° - SAE 6000 PSI
90° male

JIC - SAE 6000 PSI flange

SEDI PAG.40 / PORTS PAG.40

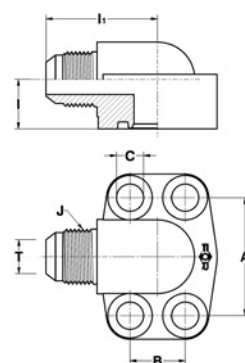

RACCORDI PER TUBI SVASATI - 37°

37° - FLARED TUBE CONNECTORS

405001

Flangia 45° orientabile maschio
 JIC cono 37° - SAE 3000 PSI
 45° (ADJ) male
 JIC - SAE 3000 PSI flange

SEDI PAG.40 / PORTS PAG.40

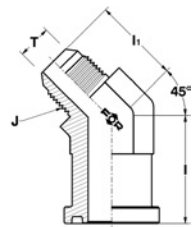

DN	T		RIFERIMENTO REFERENCE	J	I ₁	I	A	B
	SIZE	MM.						
				UNF-UN				
1/2	12	1/2	A405001/1212	3/4-16	26	37	38,10	17,48
1/2	14÷16	5/8	A405001/1216	7/8-14	28	37	38,10	17,48
3/4	14÷16	5/8	A405001/1916	7/8-14	33	42	47,63	22,23
3/4	18-20	3/4	A405001/1920	1"1/16-12	34	42	47,63	22,23
3/4	25	1"	A405001/1925	1"5/16-12	35	42	47,63	22,23
1"	18-20	3/4	A405001/2520	1"1/16-12	36	42	52,37	26,19
1"	25	1"	A405001/2525	1"5/16-12	37	42	52,37	26,19
1"	30-32	1"1/4	A405001/2532	1"5/8-12	39	42	52,37	26,19
1"1/4	25	1"	A405001/3225	1"5/16-12	37	42	58,72	30,18
1"1/4	30-32	1"1/4	A405001/3232	1"5/8-12	39	42	58,72	30,18
1"1/2	30-32	1"1/4	A405001/3832	1"5/8-12	43	50	69,85	35,71
1"1/2	38	1"1/2	A405001/3838	1"7/8-12	45	50	69,85	35,71

405506

Flangia 45° orientabile maschio
 JIC cono 37° - SAE 6000 PSI
 45° (ADJ) male
 JIC - SAE 6000 PSI flange

SEDI PAG.40 / PORTS PAG.40

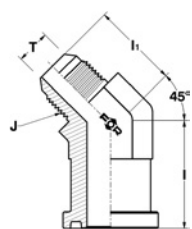

DN	T		RIFERIMENTO REFERENCE	J	I ₁	I	A	B
	SIZE	MM.						
				UNF-UN				
1/2	12	1/2	A405506/1212	3/4-16	26	38	40,49	18,24
1/2	14÷16	5/8	A405506/1216	7/8-14	28	38	40,49	18,24
3/4	14÷16	5/8	A405506/1916	7/8-14	33	42	50,80	23,80
3/4	18-20	3/4	A405506/1920	1"1/16-12	35	42	50,80	23,80
3/4	25	1"	A405506/1925	1"5/16-12	36	42	50,80	23,80
1"	18-20	3/4	A405506/2520	1"1/16-12	37	53	57,15	27,76
1"	25	1"	A405506/2525	1"5/16-12	38	53	57,15	27,76
1"	30-32	1"1/4	A405506/2532	1"5/8-12	40	60	57,15	27,76
1"1/4	25	1"	A405506/3225	1"5/16-12	40	60	66,68	31,75
1"1/4	30-32	1"1/4	A405506/3232	1"5/8-12	41	60	66,68	31,75
1"1/2	30-32	1"1/4	A405506/3832	1"5/8-12	43	70	79,38	36,50
1"1/2	38	1"1/2	A405506/3838	1"7/8-12	45	70	79,38	36,50
1/2	18-20	3/4	SA405506/1220	1"1/16-12	35	42	40,49	18,24

SEMIFLANGE
 (RIF. PER ORDINE PAG. 431)
 SPLIT FLANGES
 (REF. OF ORDER PAG. 431)

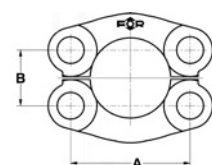



DN T			RIFERIMENTO REFERENCE	J	I ₁	I	A	B
SIZE	MM.	IN.						
1/2	12	1/2	A407002/1212	3/4-16	48	42	38,10	17,48
1/2	14÷16	5/8	A407002/1216	7/8-14	50	42	38,10	17,48
3/4	14÷16	5/8	A407002/1916	7/8-14	58	52	47,63	22,23
3/4	18-20	3/4	A407002/1920	1" 1/16-12	60	52	47,63	22,23
3/4	25	1"	A407002/1925	1" 5/16-12	61	52	47,63	22,23
1"	18-20	3/4	A407002/2520	1" 1/16-12	61	54	52,37	26,19
1"	25	1"	A407002/2525	1" 5/16-12	62	54	52,37	26,19
1"	30-32	1" 1/4	A407002/2532	1" 5/8-12	66	56	52,37	26,19
1" 1/4	25	1"	A407002/3225	1" 5/16-12	66	54	58,72	30,18
1" 1/4	30-32	1" 1/4	A407002/3232	1" 5/8-12	68	54	58,72	30,18
1" 1/2	30-32	1" 1/4	A407002/3832	1" 5/8-12	75	61	69,85	35,71
1" 1/2	38	1" 1/2	A407002/3838	1" 7/8-12	78	61	69,85	35,71
3/4	10	3/8	SA407002/1910	9/16-18	53	52	47,63	22,23
1"	38	1" 1/2	SA407002/2538	1" 7/8-12	78	76	52,37	26,19
1" 1/4	18-20	3/4	SA407002/3220	1" 1/16-12	63,5	59	58,72	30,18

407002

Flangia 90° orientabile maschio
JIC cono 37° - SAE 3000 PSI
90° (ADJ) male

JIC - SAE 3000 PSI flange

SEDI PAG.40 / PORTS PAG.40

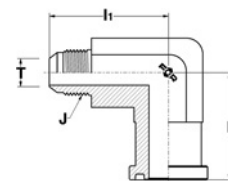

DN T			RIFERIMENTO REFERENCE	J	I ₁	I	A	B
SIZE	MM.	IN.						
1/2	12	1/2	A407507/1212	3/4-16	49	43	40,49	18,24
1/2	14÷16	5/8	A407507/1216	7/8-14	51	43	40,49	18,24
3/4	14÷16	5/8	A407507/1916	7/8-14	59	54	50,80	23,80
3/4	18-20	3/4	A407507/1920	1" 1/16-12	61	54	50,80	23,80
3/4	25	1"	A407507/1925	1" 5/16-12	62	54	50,80	23,80
1"	18-20	3/4	A407507/2520	1" 1/16-12	65	62	57,15	27,76
1"	25	1"	A407507/2525	1" 5/16-12	66	65	57,15	27,76
1"	30-32	1" 1/4	A407507/2532	1" 5/8-12	73	70	57,15	27,76
1" 1/4	25	1"	A407507/3225	1" 5/16-12	73	70	66,68	31,75
1" 1/4	30-32	1" 1/4	A407507/3232	1" 5/8-12	75	70	66,68	31,75
1" 1/2	30-32	1" 1/4	A407507/3832	1" 5/8-12	85	80	79,38	36,50
1" 1/2	38	1" 1/2	A407507/3838	1" 7/8-12	88	80	79,38	36,50
1/2	18-20	3/4	SA407507/1220	1" 1/16-12	61	53	40,49	18,24
3/4	30-32	1" 1/4	SA407507/1932	1" 5/8-12	75	70	50,80	23,80
1" 1/4	38	1" 1/2	SA407507/3238	1" 7/8-12	88	80	66,68	31,75
1" 1/2	25	1"	SA407507/3825	1" 5/16-12	83,5	80	79,38	36,50

407507

Flangia 90° orientabile maschio
JIC cono 37° - SAE 6000 PSI
90° (ADJ) male

JIC - SAE 6000 PSI flange

SEDI PAG.40 / PORTS PAG.40

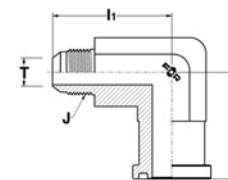

SEMIFLANGE
(RIF. PER ORDINE PAG. 431)
SPLIT FLANGES
(REF. OF ORDER PAG. 431)

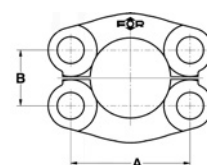

RACCORDI PER TUBI SVASATI - 37°

37° - FLARED TUBE CONNECTORS

411006

Flangia a "T" orientabile
maschi JIC cono 37° - SAE 3000
PSI

Branch (AD) tee male
JIC - SAE 3000 PSI flange

SEDI PAG.40 / PORTS PAG.40

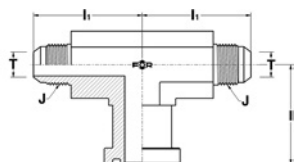

DN	T	RIFERIMENTO REFERENCE		J	l ₁	I	A	B
		SIZE	MM.					
1/2	12	1/2	A411006/1212	3/4-16	48	42	38,10	17,48
1/2	14÷16	5/8	A411006/1216	7/8-14	50	42	38,10	17,48
3/4	14÷16	5/8	A411006/1916	7/8-14	58	52	47,63	22,23
3/4	18-20	3/4	A411006/1920	1"1/16-12	60	52	47,63	22,23
3/4	25	1"	A411006/1925	1"5/16-12	61	52	47,63	22,23
1"	18-20	3/4	A411006/2520	1"1/16-12	61	54	52,37	26,19
1"	25	1"	A411006/2525	1"5/16-12	62	54	52,37	26,19
1"	30-32	1"1/4	A411006/2532	1"5/8-12	66	54	52,37	26,19
1"1/4	25	1"	A411006/3225	1"5/16-12	66	54	58,72	30,18
1"1/4	30-32	1"1/4	A411006/3232	1"5/8-12	68	54	58,72	30,18
1"1/2	30-32	1"1/4	A411006/3832	1"5/8-12	75	61	69,85	35,71
1"1/2	38	1"1/2	A411006/3838	1"7/8-12	78	61	69,85	35,71

411501

Flangia a "T" orientabile maschi
JIC cono 37° - SAE 6000 PSI

Branch (AD) tee male
JIC - SAE 6000 PSI flange

SEDI PAG.40 / PORTS PAG.40

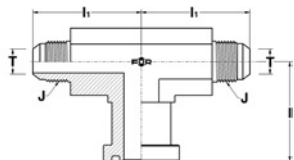

DN	T	RIFERIMENTO REFERENCE		J	l ₁	I	A	B
		SIZE	MM.					
1/2	12	1/2	A411501/1212	3/4-16	49	43	40,49	18,24
1/2	14÷16	5/8	A411501/1216	7/8-14	51	43	40,49	18,24
3/4	14÷16	5/8	A411501/1916	7/8-14	59	54	50,80	23,80
3/4	18-20	3/4	A411501/1920	1"1/16-12	61	54	50,80	23,80
3/4	25	1"	A411501/1925	1"5/16-12	62	54	50,80	23,80
1"	18-20	3/4	A411501/2520	1"1/16-12	65	65	57,15	27,76
1"	25	1"	A411501/2525	1"5/16-12	66	65	57,15	27,76
1"	30-32	1"1/4	A411501/2532	1"5/8-12	73	70	57,15	27,76
1"1/4	25	1"	A411501/3225	1"5/16-12	73	70	66,68	31,75
1"1/4	30-32	1"1/4	A411501/3232	1"5/8-12	75	70	66,68	31,75
1"1/2	30-32	1"1/4	A411501/3832	1"5/8-12	85	80	79,38	36,50
1"1/2	38	1"1/2	A411501/3838	1"7/8-12	88	80	79,38	36,50

SEMIFLANGE
(RIF. PER ORDINE PAG. 431)
SPLIT FLANGES
(REF. OF ORDER PAG. 431)

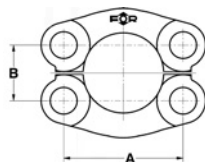



DN T			RIFERIMENTO REFERENCE	J	I ₁	I	A	B
SIZE	MM.	IN.						
1/2	12	1/2	A413008/1212	3/4-16	48	42	38,10	17,48
1/2	14÷16	5/8	A413008/1216	7/8-14	50	42	38,10	17,48
3/4	14÷16	5/8	A413008/1916	7/8-14	58	52	47,63	22,23
3/4	18-20	3/4	A413008/1920	1" 1/16-12	60	52	47,63	22,23
3/4	25	1"	A413008/1925	1" 5/16-12	61	52	47,63	22,23
1"	18-20	3/4	A413008/2520	1" 1/16-12	61	54	52,37	26,19
1"	25	1"	A413008/2525	1" 5/16-12	62	54	52,37	26,19
1"	30-32	1" 1/4	A413008/2532	1" 5/8-12	66	54	52,37	26,19
1" 1/4	25	1"	A413008/3225	1" 5/16-12	66	54	58,72	30,18
1" 1/4	30-32	1" 1/4	A413008/3232	1" 5/8-12	68	54	58,72	30,18
1" 1/2	30-32	1" 1/4	A413008/3832	1" 5/8-12	75	61	69,85	35,71
1" 1/2	38	1" 1/2	A413008/3838	1" 7/8-12	78	61	69,85	35,71
1/2	12	1/2	A413503/1212	3/4-16	49	43	40,49	18,24
1/2	14÷16	5/8	A413503/1216	7/8-14	51	43	40,49	18,24
3/4	14÷16	5/8	A413503/1916	7/8-14	59	54	50,80	23,80
3/4	18-20	3/4	A413503/1920	1" 1/16-12	61	54	50,80	23,80
3/4	25	1"	A413503/1925	1" 5/16-12	62	54	50,80	23,80
1"	18-20	3/4	A413503/2520	1" 1/16-12	65	65	57,15	27,76
1"	25	1"	A413503/2525	1" 5/16-12	66	65	57,15	27,76
1"	30-32	1" 1/4	A413503/2532	1" 5/8-12	73	70	57,15	27,76
1" 1/4	25	1"	A413503/3225	1" 5/16-12	73	70	66,68	31,75
1" 1/4	30-32	1" 1/4	A413503/3232	1" 5/8-12	75	70	66,68	31,75
1" 1/2	30-32	1" 1/4	A413503/3832	1" 5/8-12	85	80	79,38	36,50
1" 1/2	38	1" 1/2	A413503/3838	1" 7/8-12	88	80	79,38	36,50

413008

Flangia a "L" orientabile maschi
JIC cono 37° - SAE 3000 PSI
Run (ADJ) tee male
JIC - SAE 3000 PSI flange

SEDI PAG.40 / PORTS PAG.40

413503

Flangia a "L" orientabile maschi
JIC cono 37° - SAE 6000 PSI
Run (ADJ) tee male
JIC - SAE 6000 PSI flange

SEDI PAG.40 / PORTS PAG.40

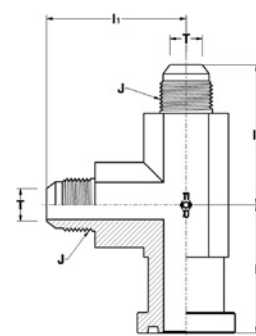

SEMIFLANGE
(RIF. PER ORDINE PAG. 431)
SPLIT FLANGES
(REF. OF ORDER PAG. 431)

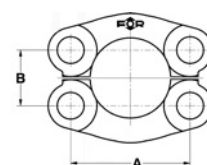

RACCORDI PER TUBI SVASATI - 37°

37° - FLARED TUBE CONNECTORS

402130

Flangia diritta maschio
 JIC cono 37° - interasse metrico
 4 fori per viti standard
 Straight male
 JIC - 4 bolts metric
 flange std. screw

SEDI PAG.42 / PORTS PAG.42

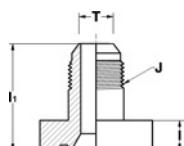

DN	T		RIFERIMENTO REFERENCE	J	I ₁	A	C	I
	SIZE	MM.						
10	10	3/8	A402130/1010	9/16-18	30	26	5,5	7
12	10	3/8	A402130/1210	9/16-18	35	30	7	9
12	12	1/2	A402130/1212	3/4-16	35	30	7	9
15	12	1/2	A402130/1512	3/4-16	38	35	7	10
15	14÷16	5/8	A402130/1516	7/8-14	40	35	7	10
20	12	1/2	A402130/2012	3/4-16	41	40	7	12
20	14÷16	5/8	A402130/2016	7/8-14	43	40	7	12
20	18-20	3/4	A402130/2020	1"1/16-12	45	40	7	12
26	18-20	3/4	A402130/2620	1"1/16-12	51	55	9	16
26	22	7/8	A402130/2622	1"3/16-12	52	55	9	16
26	25	1"	A402130/2625	1"5/16-12	52	55	9	16
26	30-32	1"1/4	A402130/2632	1"5/8-12	53	55	9	16
31	25	1"	A402130/3125	1"5/16-12	55	61	11	18
31	30-32	1"1/4	A402130/3132	1"5/8-12	57	61	11	18
32	25	1"	A402130/3225	1"5/16-12	57	62	11	18
32	30-32	1"1/4	A402130/3232	1"5/8-12	59	62	11	18
12	14÷16	5/8	SA402130/1216	7/8-14	43	30	7	9
15	18-20	3/4	SA402130/1520	1"1/16-12	44	35	7	10

402131

Flangia diritta maschio
 JIC cono 37° - interasse metrico
 4 fori per viti maggiorate
 Straight male
 JIC - 4 bolts metric
 flange heavy screw

SEDI PAG.42 / PORTS PAG.42

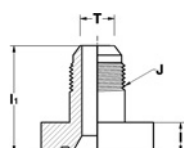

DN	T		RIFERIMENTO REFERENCE	J	I ₁	A	C	I
	SIZE	MM.						
12	10	3/8	A402131/1210	9/16-18	35	30	8,5	9
12	12	1/2	A402131/1212	3/4-16	35	30	8,5	9
15	12	1/2	A402131/1512	3/4-16	38	35	8,5	10
15	14÷16	5/8	A402131/1516	7/8-14	40	35	8,5	10
20	12	1/2	A402131/2012	3/4-16	41	40	8,5	12
20	14÷16	5/8	A402131/2016	7/8-14	43	40	8,5	12
20	18-20	3/4	A402131/2020	1"1/16-12	45	40	8,5	12
25	18-20	3/4	A402131/2520	1"1/16-12	51	51	11	16
25	22	7/8	A402131/2522	1"3/16-12	52	51	11	16
25	25	1"	A402131/2525	1"5/16-12	52	51	11	16
32	25	1"	A402131/3225	1"5/16-12	57	62	13	18
32	30-32	1"1/4	A402131/3232	1"5/8-12	59	62	13	18
40	30-32	1"1/4	A402131/4032	1"5/8-12	62	72,5	13	21
40	38	1"1/2	A402131/4038	1"7/8-12	65	72,5	13	21
20	25	1"	SA402131/2025	1"5/16-12	55	40	8,5	12



DN T			RIFERIMENTO REFERENCE	J	I ₁	I	A	C
SIZE	MM.	IN.						
10	10	3/8	A407123/1010	9/16-18	30	13.5	26	5,5
10	12	1/2	A407123/1012	3/4-16	31	13.5	26	5,5
12	10	3/8	A407123/1210	9/16-18	30	17	30	7
12	12	1/2	A407123/1212	3/4-16	32	17	30	7
12	14÷16	5/8	A407123/1216	7/8-14	35	17	30	7
15	12	1/2	A407123/1512	3/4-16	35	17	35	7
15	14÷16	5/8	A407123/1516	7/8-14	37	17	35	7
20	14÷16	5/8	A407123/2016	7/8-14	40	20	40	7
20	18-20	3/4	A407123/2020	1" 1/16-12	42	20	40	7
20	22	7/8	A407123/2022	1" 3/16-12	43	25	40	7
20	25	1"	A407123/2025	1" 5/16-12	44	25	40	7
26	18-20	3/4	A407123/2620	1" 1/16-12	47	25	55	9
26	25	1"	A407123/2625	1" 5/16-12	47	25	55	9
26	30-32	1" 1/4	A407123/2632	1" 5/8-12	49	31	55	9
31	25	1"	A407123/3125	1" 5/16-12	52	31	61	11
31	30-32	1" 1/4	A407123/3132	1" 5/8-12	54	31	61	11
31	38	1" 1/2	A407123/3138	1" 7/8-12	56	37	61	11
32	25	1"	A407123/3225	1" 5/16-12	52	31	62	11
32	30-32	1" 1/4	A407123/3232	1" 5/8-12	54	31	62	11
32	38	1" 1/2	A407123/3238	1" 7/8-12	56	37	62	11
12	18-20	3/4	SA407123/1220	1" 1/16-12	42	20	30	7
15	10	3/8	SA407123/1510	9/16-18	33	17	35	7
15	18-20	3/4	SA407123/1520	1" 1/16-12	42	20	35	7
20	12	1/2	SA407123/2012	3/4-16	37.5	20	40	7

407123

Flangia 90° maschio
JIC cono 37° - interasse metrico
3 fori per viti standard
90° male JIC - 3 bolts metric
flange std. screw
SEDI PAG.42 / PORTS PAG.42

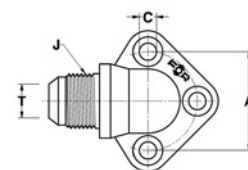
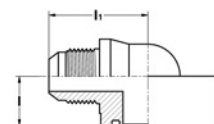

DN T			RIFERIMENTO REFERENCE	J	I ₁	I	A	C
SIZE	MM.	IN.						
12	10	3/8	A407124/1210	9/16-18	30	17	30	8,5
12	12	1/2	A407124/1212	3/4-16	32	17	30	8,5
12	14÷16	5/8	A407124/1216	7/8-14	35	17	30	8,5
15	12	1/2	A407124/1512	3/4-16	35	17	35	8,5
15	14÷16	5/8	A407124/1516	7/8-14	37	17	35	8,5
20	14÷16	5/8	A407124/2016	7/8-14	40	20	40	8,5
20	18-20	3/4	A407124/2020	1" 1/16-12	42	20	40	8,5
20	22	7/8	A407124/2022	1" 3/16-12	43	25	40	8,5
20	25	1"	A407124/2025	1" 5/16-12	44	25	40	8,5
25	18-20	3/4	A407124/2520	1" 1/16-12	47	25	51	11
25	25	1"	A407124/2525	1" 5/16-12	47	25	51	11
25	30-32	1" 1/4	A407124/2532	1" 5/8-12	49	31	51	11
32	25	1"	A407124/3225	1" 5/16-12	52	31	62	13
32	30-32	1" 1/4	A407124/3232	1" 5/8-12	54	31	62	13
32	38	1" 1/2	A407124/3238	1" 7/8-12	56	37	62	13
40	38	1" 1/2	A407124/4038	1" 7/8-12	61	37	72,5	13

407124

Flangia 90° maschio
JIC cono 37° - interasse metrico
3 fori per viti maggiorate
90° male JIC - 3 bolts metric
flange heavy screw
SEDI PAG.42 / PORTS PAG.42

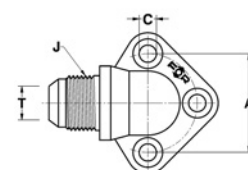
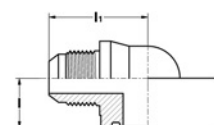

RACCORDI PER TUBI SVASATI - 37°

37° - FLARED TUBE CONNECTORS

407167

Flangia 90° maschio
JIC cono 37° - interasse metrico
4 fori per viti standard
90° male JIC - 4 bolts metric
flange std. screw

SEDI PAG.42 / PORTS PAG.42

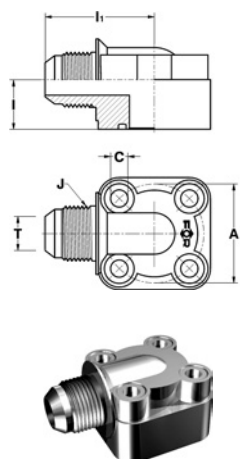

DN T			RIFERIMENTO REFERENCE	J	I ₁	I	A	C
SIZE	MM.	IN.						
10	10	3/8	A407167/1010	9/16-18	32	13.5	26	5,5
10	12	1/2	A407167/1012	3/4-16	35	13.5	26	5,5
12	10	3/8	A407167/1210	9/16-18	36	17	30	7
12	12	1/2	A407167/1212	3/4-16	38	17	30	7
12	14÷16	5/8	A407167/1216	7/8-14	40	17	30	7
15	12	1/2	A407167/1512	3/4-16	40	17	35	7
15	14÷16	5/8	A407167/1516	7/8-14	43	17	35	7
20	14÷16	5/8	A407167/2016	7/8-14	44	20	40	7
20	18-20	3/4	A407167/2020	1" 1/16-12	46	20	40	7
26	18-20	3/4	A407167/2620	1" 1/16-12	54	25	55	9
26	25	1"	A407167/2625	1" 5/16-12	55	25	55	9
26	30-32	1" 1/4	A407167/2632	1" 5/8-12	57	31	55	9
31	25	1"	A407167/3125	1" 5/16-12	60	31	61	11
31	30-32	1" 1/4	A407167/3132	1" 5/8-12	62	31	61	11
32	25	1"	A407167/3225	1" 5/16-12	60	31	62	11
32	30-32	1" 1/4	A407167/3232	1" 5/8-12	62	31	62	11
12	18-20	3/4	SA407167/1220	1" 1/16-12	43	20	30	7
20	12	1/2	SA407167/2012	3/4-16	42	20	40	7

407168

Flangia 90° maschio
JIC cono 37° - interasse metrico
4 fori per viti maggiorate
90° male JIC - 4 bolts metric
flange heavy screw

SEDI PAG.42 / PORTS PAG.42

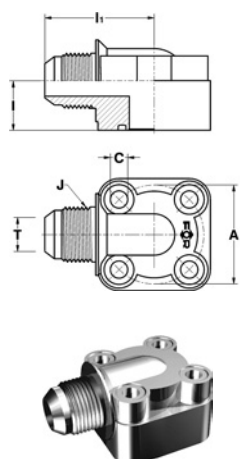

DN T			RIFERIMENTO REFERENCE	J	I ₁	I	A	C
SIZE	MM.	IN.						
12	10	3/8	A407168/1210	9/16-18	36	17	30	8,5
15	12	1/2	A407168/1512	3/4-16	40	17	35	8,5
15	14÷16	5/8	A407168/1516	7/8-14	43	17	35	8,5
20	14÷16	5/8	A407168/2016	7/8-14	44	20	40	8,5
20	18-20	3/4	A407168/2020	1" 1/16-12	46	20	40	8,5
25	18-20	3/4	A407168/2520	1" 1/16-12	54	25	51	11
25	25	1"	A407168/2525	1" 5/16-12	55	25	51	11
32	25	1"	A407168/3225	1" 5/16-12	60	31	62	13
32	30-32	1" 1/4	A407168/3232	1" 5/8-12	62	31	62	13
40	30-32	1" 1/4	A407168/4032	1" 5/8-12	66	37	72,5	13
40	38	1" 1/2	A407168/4038	1" 7/8-12	69	37	72,5	13