

ARMATURA I ZAWORY PNEUMATYCZNE

RQS[®]
RIGHT QUALITY SOLUTIONS



ARMATURA I ZAWORY PNEUMATYCZNE



POLSKA FIRMA

Jesteśmy firmą opartą na polskim kapitale, posiadającą ponad 20-letnie doświadczenie i ugruntowaną pozycję w kraju i za granicą. Dostarczając produkty wysokiej jakości kładziemy szczególny nacisk na podnoszenie kwalifikacji naszych pracowników i partnerów handlowych, jak również edukację i szkolenie odbiorców. Produkty sygnowane własną marką RQS - Right Quality Solutions - pracują niezawodnie w tysiącach polskich fabryk.

SZEROKI ZAKRES DZIAŁALNOŚCI

Wspieramy rozwój technologiczny wielu branż przemysłu, inwestujemy w narzędzia symulacyjne oraz programistyczne, aby w pełni odpowiadać na potrzeby produktowe i systemowe przedsiębiorstw. Ponadto dział R&D przeprowadza testy i badania produktów przed wprowadzeniem ich na rynek, co daje pewność, że odbiorcy otrzymają wyłącznie sprawdzone rozwiązania. Koncentrujemy się na oferowaniu produktów z najlepszym stosunkiem jakości do ceny.

ZAKRES NASZEJ DZIAŁALNOŚCI:

- sprzedaż
- produkcja
- doradztwo techniczne
- szkolenia i instruktaże

ŚWIATOWE TECHNOLOGIE

Współpracujemy z czołowymi producentami działającymi w obszarze komponentów przemysłowych, w szczególności automatyki pneumatycznej, systemów złącznych, elementów do transportu oraz kontroli przepływu mediów gazowych i płynnych. Jesteśmy wyłącznym przedstawicielem w Polsce takich marek jak: ACL, AKO, CLASSIC FILTERS, FASTER, DK-LOK, PNEUMAX, RECTUS, O'BRIEN, OMAL, SERTO, TALKOB, TEMA, TESCOM. Przy wsparciu naszych partnerów jesteśmy w stanie realizować najbardziej wymagające projekty.

NOWOCZESNY MAGAZYN

Jesteśmy świadomi, jak istotna dla naszych klientów jest szybkość realizacji zamówień, dlatego też wdrożyliśmy nowoczesne rozwiązania logistyczne i systemowe:

- system klasy WMS (Warehouse Management System)
- 30 000 lokacji w regałach automatycznych
- 3000 lokacji regałowych
- ciągła inwentaryzacja

Zapraszamy do kontaktu i współpracy.

Do Państwa dyspozycji jest ponad trzydziestu inżynierów, którzy zbadają potrzeby, a także wskażą odpowiednie rozwiązania i produkty.

NORMY

Wszystkie elementy spełniają wymogi dyrektywy ciśnieniowej PED 2014/68/UE, armatura gwintowana jest zgodna z dyrektywą 2011/65/UE (RoHS).

GWINTY

BSPP - gwint Withworth'a rurowy walcowy DIN/ISO 228 (oznaczony w katalogu jako gwint G).
 BSPT - gwint Withworth'a stożkowy ISO 7/1. (oznaczony w katalogu jako gwint R).
 M - gwint metryczny ISO/DIN 13

BUDOWA

Armatura pneumatyczna:

Mosiądz MS58
 Mosiądz MS58 niklowany
 Aluminium (elementy VB, AD)
 Aluminium anodyzowane na czarno (element WD)
 PVC (element PD)
 Fibra (element FD)
 NBR (O-ringi)

Zawory suwakowe:

Korpus zaworu: odlew mosiężny chromowany
 Tuleja suwakowa: aluminium anodyzowane w kolorze niebieskim
 Uszczelnienie: NBR

Zawory kulowe:

Korpus zaworu: odlew mosiężny chromowany, stal nierdzewna CF8M*
 Materiał kuli: mosiądz niklowany, stal nierdzewna F316*
 Rączka: PA6+ włókno szklane, aluminium A1*
 Uszczelnienie trzpienia: FKM, PTFE*

Reduktory ciśnienia:

Korpus zaworu – mosiądz MS58

CIŚNIENIE ROBOCZE

Armatura pneumatyczna:

M5 maks. 100 bar
 1/8 maks. 150 bar
 1/4 maks. 100 bar
 3/8 maks. 80 bar
 1/2 maks. 50 bar
 3/4 maks. 85 bar
 1" maks. 80 bar

Zawory kulowe i suwakowe:

maks. 10 bar
 maks. 63 bar*
 Współczynnik bezpieczeństwa 4:1.

Reduktor ciśnienia:

maks. 15bar

MEDIA

Sprężone powietrze, woda, oleje oraz płyny i gazy zgodne z zastosowanymi materiałami.

TEMPERATURA

Armatura pneumatyczna:

-20°C +80°C

Zawory kulowe:

-10°C +90°C
 -25°C +160°C*

Zawory suwakowe:

-5°C +70°C

*w przypadku kwasoodpornych zaworów kulowych BV110

ARMATURA NIKLOWANA



GI s.7



GT...OR s.7



GT s.8



GL s.8



GLI s.9



RL...L s.9



RK...K s.9



RK s.10



RL...K s.10



RL s.10



WA...K s.11



WAI...K s.11



WI s.11



TA...K s.12



TAI...K s.12



TI s.12



TAIN...W s.13



TAIN...Z s.13



KI s.13



YA...K s.14



YI s.14



VZ s.14



PP s.14



VK...K s.15



VK s.15



VZ...OR s.15



DN s.16



DN...K s.16



LD...K s.17



LD...K* s.17



LDI...K s.17



VB s.18



MU s.18



KM s.18

* ŁĄCZNIK ROZDZIELNY REDUKCYJNY

ARMATURA MOSIĘŻNA



UR/UL	s.19	STP	s.19	STD	s.19	GT	s.20	GI	s.20	DS	s.21	DK	s.21
-------	------	-----	------	-----	------	----	------	----	------	----	------	----	------



DN	s.21	LD...K	s.22	RK	s.22	RL	s.22	MU	s.23	VB	s.23	VZ	s.23
----	------	--------	------	----	------	----	------	----	------	----	------	----	------



VK	s.23	PD	s.24	FD	s.24	AD	s.24	DV	s.24	SV	s.25	TA	s.25
----	------	----	------	----	------	----	------	----	------	----	------	----	------



WA	s.25	TI	s.25	WI	s.26	YA	s.26	YI	s.26	ZO	s.26	DO	s.27
----	------	----	------	----	------	----	------	----	------	----	------	----	------



ZM	s.27	DM	s.27	WD	s.28	WD	s.28
----	------	----	------	----	------	----	------

ZAWORY PNEUMATYCZNE



BVC1	s.30	BVC1	s.30	BVC2	s.30	BVC2	s.30	SVB	s.31	BV110	s.31	DRV	s.31
------	------	------	------	------	------	------	------	-----	------	-------	------	-----	------



ARMATURA



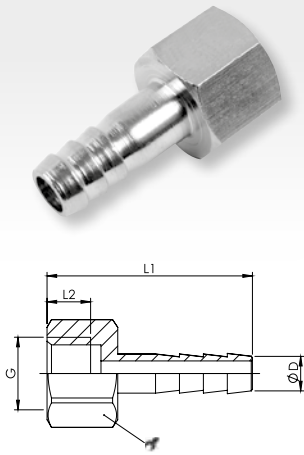

GI - TULEJA Z GWINTEM WEWNĘTRZNYM WALCOWYM BSPP

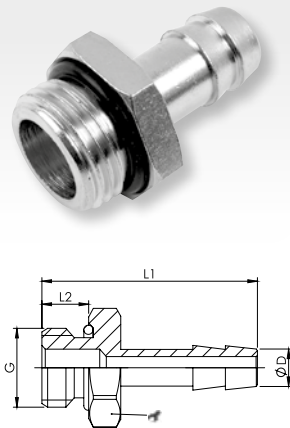

Kod produktu	G	D [Ø]		L1 [mm]	L2 [mm]	ilość w opak.
GI 1806	1/8"	6	14	30,5	8	25 szt.
GI 1808		8	14	30,5	8	25 szt.
GI 1406	1/4"	6	17	33,5	11	25 szt.
GI 1408		8	17	33,5	11	25 szt.
GI 1409		9	17	33,5	11	25 szt.
GI 3806	3/8"	6	20	36,5	12	25 szt.
GI 3808		8	20	36,5	12	25 szt.
GI 3809		9	20	36,5	12	25 szt.
GI 3813		13	20	36,5	12	25 szt.
GI 1206	1/2"	6	24	41,5	14	25 szt.
GI 1209		9	24	41,5	14	25 szt.
GI 1213		13	24	41,5	14	25 szt.

GT...OR - TULEJA Z GWINTEM ZEWNĘTRZNYM WALCOWYM BSPP Z USZCZELKĄ



Kod produktu	G	D [Ø]		L1 [mm]	L2 [mm]	ilość w opak.
GT 1806 OR	1/8"	6	14	30	6,5	50 szt.
GT 1808 OR		8	14	30	6,5	50 szt.
GT 1809 OR		9	14	30	6,5	50 szt.
GT 1406 OR	1/4"	6	17	32	8	50 szt.
GT 1408 OR		8	17	32	8	50 szt.
GT 1409 OR		9	17	32	8	50 szt.
GT 1413 OR		13	17	33	8	50 szt.
GT 3806 OR	3/8"	6	20	33	9	50 szt.
GT 3808 OR		8	20	33	9	50 szt.
GT 3809 OR		9	20	33	9	50 szt.
GT 3813 OR		13	20	38	9	50 szt.
GT 1206 OR	1/2"	6	25	36	10	25 szt.
GT 1209 OR		9	25	36	10	50 szt.
GT 1213 OR		13	25	40	10	50 szt.
GT 1216 OR		16	25	40	10	25 szt.
GT 1219 OR		19	25	40	10	10 szt.
GT 3419 OR	3/4"	19	32	43	12	10 szt.
GT 3425 OR		25	32	49	12	10 szt.

GT - TULEJA Z GWINTEM ZEWNĘTRZNYM WALCOWYM BSPP

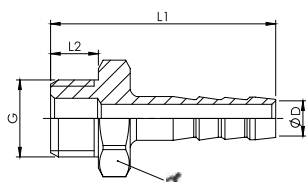

Kod produktu	G	D [Ø]		L1 [mm]	L2 [mm]	ilość w opak.
GT 1806	1/8"	6	14	31	6,5	50 szt.
GT 1808		8	14	31	6,5	50 szt.
GT 1809		9	14	31	6,5	50 szt.
GT 1406	1/4"	6	17	33	8	50 szt.
GT 1407		7	17	33	8	50 szt.
GT 1408		8	17	35	8	50 szt.
GT 1409		9	17	35	8	50 szt.
GT 1410		10	17	35	8	50 szt.
GT 1411		11	17	35	8	50 szt.
GT 1413		13	17	35	8	50 szt.
GT 3806	3/8"	6	19	35	9	50 szt.
GT 3808		8	19	36	9	50 szt.
GT 3809		9	19	36	9	50 szt.
GT 3810		10	19	36	9	50 szt.
GT 3811		11	19	36	9	50 szt.
GT 3813		13	19	38	9	50 szt.
GT 3816		16	19	38	9	50 szt.
GT 1206	1/2"	6	24	36	10	25 szt.
GT 1207		7	24	36	10	50 szt.
GT 1208		8	24	36	10	50 szt.
GT 1209		9	24	36	10	50 szt.
GT 1210		10	24	36	10	50 szt.
GT 1211		11	24	36	10	50 szt.
GT 1213		13	24	38	10	50 szt.
GT 1215		15	24	38	10	50 szt.
GT 1216		16	24	40	10	25 szt.
GT 1219		19	24	40	10	10 szt.
GT 3413	3/4"	13	30	41	12	10 szt.
GT 3416		16	30	43	12	10 szt.
GT 3419		19	30	47	12	10 szt.
GT 3425		25	30	53	12	10 szt.
GT 119	1"	19	27	50,5	12	10 szt.
GT 125		25	28	61	13	10 szt.

GL - TULEJA KĄTOWA Z GWINTEM ZEWNĘTRZNYM WALCOWYM BSPP

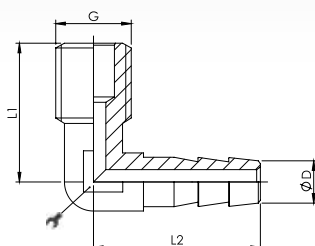

Kod produktu	G	D [Ø]		L1 [mm]	L2 [mm]	L3 [mm]	ilość w opak.
GL 1806	1/8"	6	9	18	21,5	9	50 szt.
GL 1807		7	10	19	22,5	9	50 szt.
GL 1808		8	10	19	22,5	8	50 szt.
GL 1809		9	11	20	24	8	50 szt.
GL 1406	1/4"	6	10	22	22,5	11	50 szt.
GL 1407		7	10	22	22,5	11	50 szt.
GL 1408		8	10	22	22,5	11	50 szt.
GL 1409		9	11	22	24	11	50 szt.
GL 1411		11	10	22	22,5	11	50 szt.



GLI - TULEJA KĄTOWA Z GWINTEM WEWNĘTRZNYM WALCOWYM BSPP

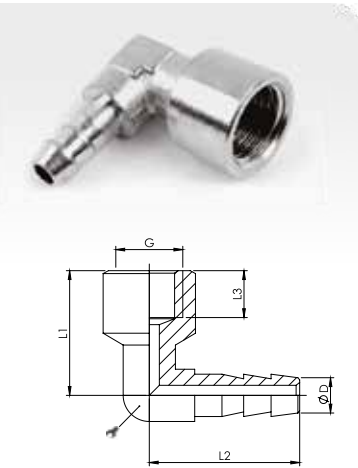

Kod produktu	G	D [Ø]		L1 [mm]	L2 [mm]	L3 [mm]	ilość w opak.
GLI 1806	1/8"	6	10	22	22,5	8	50 szt.
GLI 1807		7	10	22	22,5	8	50 szt.
GLI 1808		8	10	22	22,5	8	50 szt.
GLI 1809		9	11	11	22	24	8
GLI 1406	1/4"	6	11	23,5	23,5	9	50 szt.
GLI 1407		7	11	23,5	23,5	9	50 szt.
GLI 1408		8	11	23,5	25	9	50 szt.
GLI 1409		9	11	23,5	23,5	9	50 szt.
GLI 1411		11	14	14	27,5	27	9

RL...L - REDUKCJA PRZEDŁUŻANA Z GWINTEM ZEWNĘTRZNYM WALCOWYM BSPP - WEWNĘTRZNYM WALCOWYM BSPP

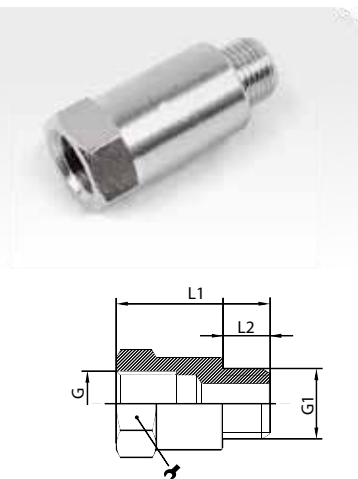

Kod produktu	G	G1		L1 [mm]	L2 [mm]	ilość w opak.
RL 1823 L	1/8"	1/8"	14	23	7	25 szt.
RL 1826 L			14	26	7	25 szt.
RL 1829 L			14	29	7	25 szt.
RL 1832 L			14	32	7	25 szt.
RL 1843 L			14	43	7	25 szt.
RL 1435 L	1/4"	1/4"	17	35	8	25 szt.
RL 1451 L			17	51	8	25 szt.

RK...K - REDUKCJA KRÓTKA Z GWINTEM ZEWNĘTRZNYM STOŻKOWYM BSPT - WEWNĘTRZNYM WALCOWYM BSPP

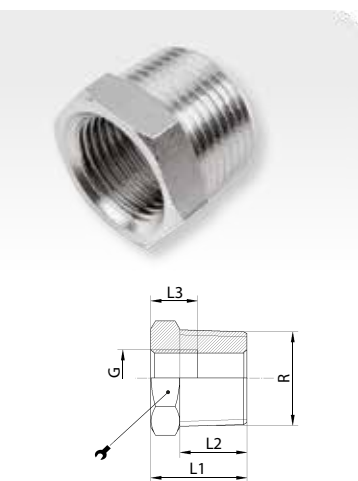

Kod produktu	R	G		L1 [mm]	L2 [mm]	L3 [mm]	ilość w opak.
RK 1418 K	1/4"	1/8"	14	16	11	8	50 szt.
RK 3818 K	3/8"	1/8"	17	16,5	11,5	8	25 szt.
RK 3814 K		1/4"	17	16,5	11,5	11	50 szt.
RK 1218 K	1/2"	1/8"	22	19,5	14	8	25 szt.
RK 1214 K		1/4"	22	19,5	14	11	50 szt.
RK 1238 K		3/8"	22	19,5	14	14	50 szt.
RK 3438 K	3/4"	3/8"	27	23,5	16	16	25 szt.
RK 3412 K		1/2"	27	23,5	16	16	25 szt.
RK 138 K	1"	3/8"	34	25	17	14	10 szt.
RK 112 K		1/2"	34	25	17	16	25 szt.
RK 134 K		3/4"	34	25	17	16	25 szt.

RK - REDUKCJA KRÓTKA Z GWINTEM ZEWNĘTRZNYM WALCOWYM BSPP - WEWNĘTRZNYM WALCOWYM BSPP

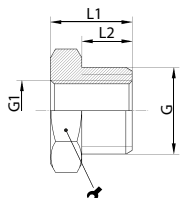

Kod produktu	G	G1		L1 [mm]	L2 [mm]	ilość w opak.
RK 18M5	1/8"	M5	14	10,5	6	10 szt.
RK 1418	1/4"	1/8"	17	13	8	50 szt.
RK 3818	3/8"	1/8"	19	14	9	25 szt.
RK 3814		1/4"	19	14	9	50 szt.
RK 1218	1/2"	1/8"	24	15,5	10	25 szt.
RK 1214		1/4"	24	15,5	10	50 szt.
RK 1238		3/8"	24	15,5	10	50 szt.
RK 3438	3/4"	3/8"	30	17,5	11	25 szt.
RK 3412		1/2"	30	17,5	11	50 szt.

RL...K - REDUKCJA DŁUGA Z GWINTEM ZEWNĘTRZNYM STOŻKOWYM BSPT - WEWNĘTRZNYM WALCOWYM BSPP

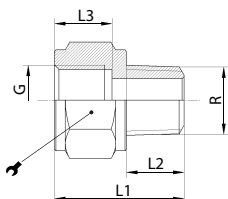

Kod produktu	R	G		L1 [mm]	L2 [mm]	L3 [mm]	ilość w opak.
RL 1818 K	1/8"	1/8"	14	18	8	8	25 szt.
RL 1814 K		1/4"	17	22,5	8	12	25 szt.
RL 1838 K		3/8"	22	23	8	12	25 szt.
RL 1414 K	1/4"	1/4"	17	25,5	11	12	25 szt.
RL 1438 K		3/8"	22	26	11	12	25 szt.
RL 1412 K		1/2"	24	28	11	14	25 szt.
RL 3838 K	3/8"	3/8"	22	27	12	12	25 szt.
RL 3812 K		1/2"	24	29	12	14	25 szt.
RL 3834 K		3/4"	30	29	12	14	10 szt.
RL 1212 K	1/2"	1/2"	24	31	14	14	25 szt.
RL 1234 K		3/4"	30	31	14	14	25 szt.
RL 3434 K	3/4"	3/4"	30	33	16	14	10 szt.

RL - REDUKCJA DŁUGA Z GWINTEM ZEWNĘTRZNYM WALCOWYM BSPP - WEWNĘTRZNYM WALCOWYM BSPP

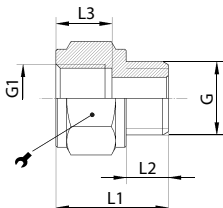

Kod produktu	G	G1		L1 [mm]	L2 [mm]	L3 [mm]	ilość w opak.
RL M518	M5	1/8"	14	15	5	8	25 szt.
RL 1818	1/8"	1/8"	14	16	6	8	25 szt.
RL 1814		1/4"	17	20,5	6	12	25 szt.
RL 1838		3/8"	22	20,5	6	12	25 szt.
RL 1414	1/4"	1/4"	17	22,5	8	12	50 szt.
RL 1438		3/8"	22	23	8	12	50 szt.
RL 1412		1/2"	24	25	8	14	25 szt.
RL 3838	3/8"	3/8"	22	24	9	12	25 szt.
RL 3812		1/2"	24	26	9	14	25 szt.
RL 3834		3/4"	30	26	9	14	25 szt.
RL 1212	1/2"	1/2"	27	27	10	14	25 szt.
RL 1234		3/4"	30	27	10	14	25 szt.
RL 3434	3/4"	3/4"	32	28	11	14	10 szt.



WA - KOLANKO Z GWINTAMI ZEWNĘTRZNYMI STOŻKOWYMI BSPT

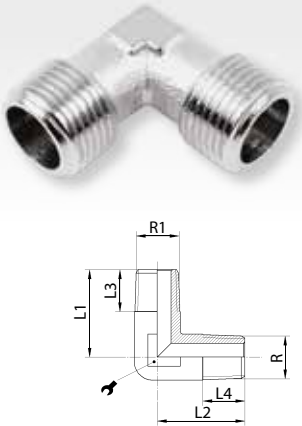

Kod produktu	R	R1		L1 [mm]	L2 [mm]	L3 [mm]	L4 [mm]	ilość w opak.
WA 18 K	1/8"	1/8"	10	19	19	8	8	25 szt.
WA 1814 K	1/8"	1/4"	10	19	21	8	11	25 szt.
WA 14 K	1/4"	1/4"	13	24	24	11	11	25 szt.
WA 1438 K	1/4"	3/8"	14	24	25,5	11	11,5	25 szt.
WA 38 K	3/8"	3/8"	17	26	26	11,5	11,5	25 szt.
WA 12 K	1/2"	1/2"	21	31,5	31,5	14	14	25 szt.
WA 34 K	3/4"	3/4"	25	33	33	16	16	25 szt.
WA 1 K	1"	1"	30	39	39	17,5	17,5	10 szt.

WAI - KOLANKO Z GWINTEM ZEWNĘTRZNYM STOŻKOWYM BSPT - WEWNĘTRZNYM WALCOWYM BSPP

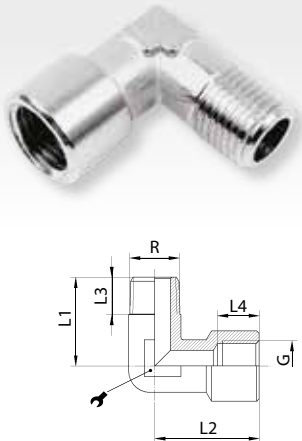

Kod produktu	R	G		L1 [mm]	L2 [mm]	L3 [mm]	L4 [mm]	ilość w opak.
WAI 18 K	1/8"	1/8"	10-sty	17	20	8	8	25 szt.
WAI 1814 K	1/8"	1/4"	11	19	23	8	11	25 szt.
WAI 1418 K	1/4"	1/8"	10	20,5	21	11	8	25 szt.
WAI 14 K	1/4"	1/4"	14	25	26,5	11	11	25 szt.
WAI 1438 K	1/4"	3/8"	17	25	28	11	11,5	25 szt.
WAI 3814 K	3/8"	1/4"	14	25,5	26,5	11,5	11	25 szt.
WAI 38 K	3/8"	3/8"	17	26	28	11,5	12	25 szt.
WAI 12 K	1/2"	1/2"	21	31	33,5	14	14	25 szt.
WAI 34 K	3/4"	3/4"	25	33	36,5	16	16,5	25 szt.
WAI 1 K	1"	1"	30	45	39	17,5	19	10 szt.

WI - KOLANKO Z GWINTAMI WEWNĘTRZNYMI WALCOWYMI BSPP

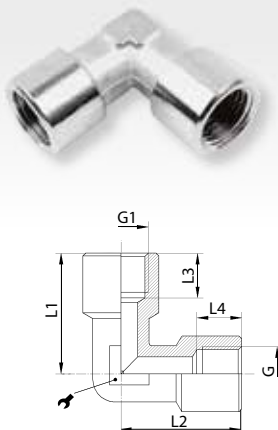

Kod produktu	R	G		L1 [mm]	L2 [mm]	L3 [mm]	L4 [mm]	ilość w opak.
WI 18	1/8"	1/8"	10	21	21	8	8	25 szt.
WI 1814	1/8"	1/4"	14	24	26,5	8	11	25 szt.
WI 14	1/4"	1/4"	14	26,5	26,5	11	11	25 szt.
WI 1438	1/4"	3/8"	14	26	28	11	12	25 szt.
WI 38	3/8"	3/8"	17	28	28	12	12	25 szt.
WI 12	1/2"	1/2"	21	33,5	33,5	14	14	25 szt.
WI 34	3/4"	3/4"	25	36,5	36,5	16,5	16,5	25 szt.
WI 1	1"	1"	30	45	45	19	19	10 szt.

TA - ZŁĄCZE T Z GWINTAMI ZEWNĘTRZNYMI STOŻKOWYMI BSPT

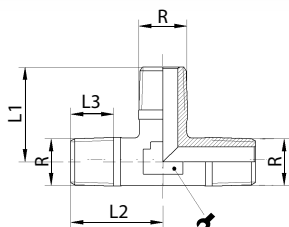

Kod produktu	R		L1 [mm]	L2 [mm]	L3 [mm]	ilość w opak.
TA 18 K	1/8"	11	18,5	19	8	25 szt.
TA 14 K	1/4"	12	24,75	24,75	11	25 szt.
TA 38 K	3/8"	13	28,5	28,5	11,5	25 szt.
TA 12 K	1/2"	17	31,75	31,75	14	25 szt.
TA 34 K	3/4"	22	33,2	33,2	16	10 szt.
TA 1 K	1"	30	39	39	17,5	5 szt.

TAI - ZŁĄCZE T Z GWINTEM ZEWNĘTRZNYM STOŻKOWYM BSPT - WEWNĘTRZNYMI WALCOWYMI BSPP

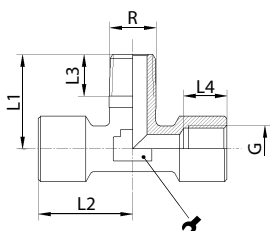

Kod produktu	R	G		L1 [mm]	L2 [mm]	L3 [mm]	L4 [mm]	ilość w opak.
TAI 18 K	1/8"	1/8"	10	19,5	19,5	8	9	25 szt.
TAI 14 K	1/4"	1/4"	13	24,8	25,8	11	11	25 szt.
TAI 38 K	3/8"	3/8"	17	28,5	30	11,5	13	25 szt.
TAI 12 K	1/2"	1/2"	22	31,8	34,8	14	14	25 szt.
TAI 34 K	3/4"	3/4"	25	33	36,5	16	16,5	10 szt.
TAI 1 K	1"	1"	30	39	45	17,5	19	5 szt.

TI - ZŁĄCZE T Z GWINTAMI WEWNĘTRZNYMI WALCOWYMI BSPP

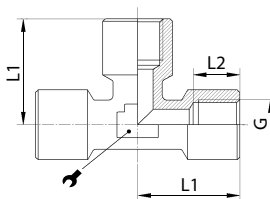

Kod produktu	G		L1 [mm]	L2 [mm]	ilość w opak.
TI 18	1/8"	10	20,5	9	25 szt.
TI 14	1/4"	13	25,8	11	25 szt.
TI 38	3/8"	17	30	12	25 szt.
TI 12	1/2"	22	34,8	14	25 szt.
TI 34	3/4"	25	36,5	16,5	10 szt.
TI 1	1"	30	45	19	5 szt.



TAIN...W - ZŁĄCZET NIESYMETRYCZNE Z GWINTEM ZEWNĘTRZNYM STOŻKOWYM BSPT - WEWNĘTRZNYMI WALCOWYMI BSPP

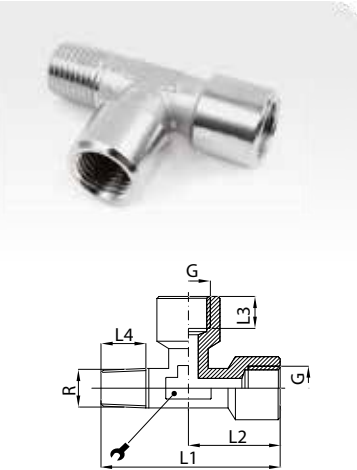

Kod produktu	R	G		L1 [mm]	L2 [mm]	L3 [mm]	L4 [mm]	ilość w opak.
TAIN M5 W	M5	M5	9	22,5	11,3	5	4	25 szt.
TAIN 18 W	1/8"	1/8"	10	38	19,5	9	8	25 szt.
TAIN 14 W	1/4"	1/4"	13	50,5	25,8	11	11	25 szt.
TAIN 38 W	3/8"	3/8"	17	58,5	30	13	11,5	25 szt.
TAIN 12 W	1/2"	1/2"	22	66,5	34,8	14	14	25 szt.
TAIN 34 W	3/4"	3/4"	25	69,5	34,8	16,5	16	10 szt.
TAIN 1 W	1"	1"	30	84	42	19	17,5	5 szt.

TAIN...Z - ZŁĄCZET Z GWINTEM WEWNĘTRZNYM WALCOWYM BSPP - ZEWNĘTRZNYMI STOŻKOWYMI BSPT

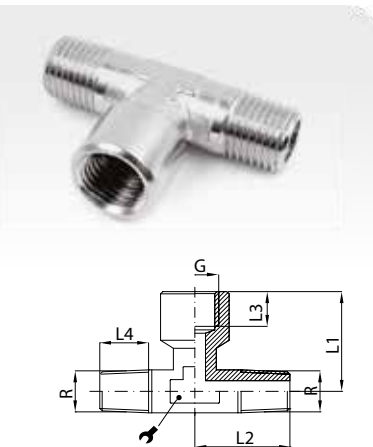

Kod produktu	R	G		L1 [mm]	L2 [mm]	L3 [mm]	L4 [mm]	ilość w opak.
TAIN 18 Z	1/8"	1/8"	10	20,5	18,5	9	8	25 szt.
TAIN 14 Z	1/4"	1/4"	13	25,8	24,8	11	11	25 szt.
TAIN 38 Z	3/8"	3/8"	17	28,5	28,5	13	11,5	25 szt.
TAIN 12 Z	1/2"	1/2"	22	34,8	31,8	14	14	25 szt.
TAIN 34 Z	3/4"	3/4"	25	36,5	33	16,5	16,2	10 szt.
TAIN 1 Z	1"	1"	30	45	36,5	19	17,5	5 szt.

KI - ZŁĄCZE KRZYŻOWE Z GWINTAMI WEWNĘTRZNYMI WALCOWYMI BSPP

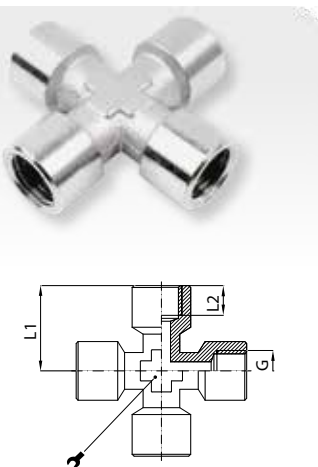

Kod produktu	G		L1 [mm]	L2 [mm]	ilość w opak.
KI 18	1/8"	10	21	8	10 szt.
KI 14	1/4"	13	25,5	11	10 szt.
KI 38	3/8"	17	28	11,5	10 szt.
KI 12	1/2"	21	33,5	14	10 szt.

YA - DWÓJNIK Z GWINTEM ZEWNĘTRZNYM STOŻKOWYM BSPT - WEWNĘTRZNYMI WALCOWYMI BSPP

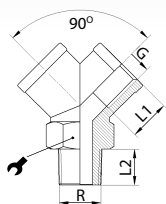

Kod produktu	R	G		L1 [mm]	L2 [mm]	ilość w opak.
YA 18 K	1/8"	1/8"	13	8	8	25 szt.
YA 14 K	1/4"	1/4"	17	11	11	25 szt.
YA 38 K	3/8"	3/8"	20	11,5	11,5	25 szt.
YA 12 K	1/2"	1/2"	25	14	14	25 szt.

YI - DWÓJNIK Z GWINTAMI WEWNĘTRZNYMI WALCOWYMI BSPP

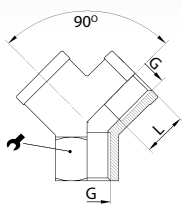

Kod produktu	G		L [mm]	ilość w opak.
YI 18	1/8"	13	8	25 szt.
YI 14	1/4"	17	11	25 szt.
YI 38	3/8"	20	11,5	25 szt.
YI 12	1/2"	25	14	25 szt.

VZ - KOREK Z KOŁNIERZEM I GWINTEM ZEWNĘTRZNYM WALCOWYM BSPP

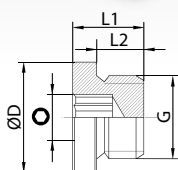

Kod produktu	G	D [Ø]		L1 [mm]	L2 [mm]	ilość w opak.
VZ 18	1/8"	14	5	8	6	25 szt.
VZ 14	1/4"	18	6	10	8	25 szt.
VZ 38	3/8"	22	8	12	9	25 szt.
VZ 12	1/2"	26	10	14	11	25 szt.
VZ 34	3/4"	32	12	20	16	10 szt.
VZ 1	1"	40	17	21	16	10 szt.

PP - KOREK POD KLUCZ Z GWINTEM ZEWNĘTRZNYM WALCOWYM BSPP

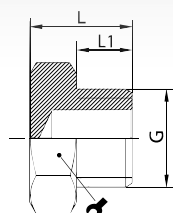

Kod produktu	G		L [mm]	L1 [mm]	ilość w opak.
PP M5	M5	8	7,5	4	25 szt.
PP 18	1/8"	14	11	6	25 szt.
PP 14	1/4"	17	13	8	25 szt.
PP 38	3/8"	19	14,5	9	25 szt.
PP 12	1/2"	24	15	9	25 szt.
PP 34	3/4"	30	17	11	10 szt.
PP 1	1"	40	18	12	10 szt.

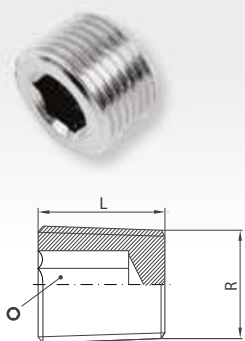

VK...K - KOREK Z GWINTEM ZEWNĘTRZNYM STOŻKOWYM BSPT

Kod produktu	R	⊙	L [mm]	ilość w opak.
VK 18 K	1/8"	5	8	25 szt.
VK 14 K	1/4"	6	10	25 szt.
VK 38 K	3/8"	8	11	25 szt.
VK 12 K	1/2"	10	13	25 szt.

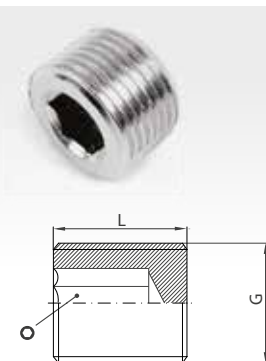
VK - KOREK Z GWINTEM ZEWNĘTRZNYM WALCOWYM BSPP

Kod produktu	G	⊙	L [mm]	ilość w opak.
VK 18	1/8"	5	8	25 szt.
VK 14	1/4"	6	10	25 szt.
VK 38	3/8"	8	11	25 szt.
VK 12	1/2"	10	13	25 szt.
VK 34	3/4"	12	15	25 szt.

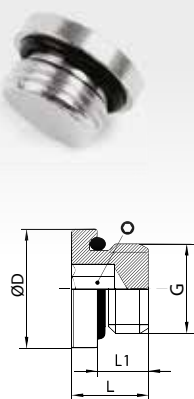
VZ...OR - KOREK Z GWINTEM ZEWNĘTRZNYM WALCOWYM BSPP Z USZCZELKĄ

Kod produktu	G	⊙	L [mm]	L1 [mm]	D [Ø]	ilość w opak.
VZ M5 OR	M5	2,5	6	4	8	25 szt.
VZ 18 OR	1/8"	5	9	6	14	25 szt.
VZ 14 OR	1/4"	6	11,5	8	18	25 szt.
VZ 38 OR	3/8"	8	12,5	9	22	25 szt.
VZ 12 OR	1/2"	10	14,5	10	26	25 szt.
VZ 34 OR	3/4"	12	20	15,5	32	10 szt.
VZ 1 OR	1"	17	21	16	40	10 szt.

DN - ŁĄCZNIK Z GWINTAMI ZEWNĘTRZNYMI WALCOWYMI BSPP

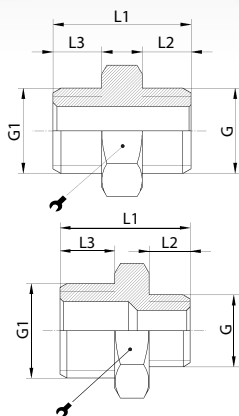

Kod produktu	G	G1		L1 [mm]	L2 [mm]	L3 [mm]	ilość w opak.
DN M5M5	M5	M5	8	11,5	4	4	10 szt.
DN M518		1/8"	14	14	4	6	10 szt.
DN 1818	1/8"	1/8"	14	17	6	6	50 szt.
DN 1814		1/4"	17	19	6	8	50 szt.
DN 1838		3/8"	19	20	6	9	50 szt.
DN 1812		1/2"	24	22	6	10	25 szt.
DN 1414	1/4"	1/4"	17	21	8	8	50 szt.
DN 1438		3/8"	19	22	8	9	50 szt.
DN 1412	1/2"	1/2"	24	24	8	10	25 szt.
DN 3838		3/8"	19	24	9	9	50 szt.
DN 3812	3/8"	1/2"	24	25	9	10	50 szt.
DN 3834		3/4"	30	26	9	11	25 szt.
DN 1212	1/2"	1/2"	24	26	10	10	50 szt.
DN 1234		3/4"	30	28	10	11	25 szt.
DN 121	3/4"	1"	36	35	10	14	25 szt.
DN 3434		3/4"	30	29	11	11	25 szt.
DN 341	1"	1"	36	38,5	14,5	14	25 szt.
DN 11		1"	33	37	14,5	14,5	25 szt.

DN - ŁĄCZNIK Z GWINTAMI ZEWNĘTRZNYMI STOŻKOWYMI BSPT

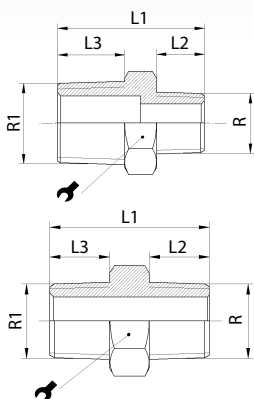

Kod produktu	R	R1		L1 [mm]	L2 [mm]	L3 [mm]	ilość w opak.
DN 1818 K	1/8"	1/8"	12	20	7,5	7,5	50 szt.
DN 1814 K		1/4"	14	23	7,5	10,5	50 szt.
DN 1838 K		3/8"	17	24	7,5	11,5	50 szt.
DN 1812 K		1/2"	22	27	7,5	14	25 szt.
DN 1414 K	1/4"	1/4"	14	26	10,5	10,5	50 szt.
DN 1438 K		3/8"	17	27	10,5	11,5	50 szt.
DN 1412 K	1/2"	1/2"	22	32	11,5	14	25 szt.
DN 3838 K		3/8"	17	28	11,5	11,5	50 szt.
DN 3812 K	3/8"	1/2"	22	32	11,5	14	50 szt.
DN 3834 K		3/4"	27	32	11,5	14	25 szt.
DN 1212 K	1/2"	1/2"	22	33,5	14	14	50 szt.
DN 1234 K		3/4"	27	35	14	14	25 szt.
DN 3434 K	3/4"	3/4"	27	35	14	14	25 szt.
DN 341 K		1"	34	43	16	19	25 szt.
DN 11 K	1"	1"	34	46	19	19	25 szt.



LD - ŁĄCZNIK ROZDZIELNY Z GWINTAMI ZEWNĘTRZNYMI STOŻKOWYMI BSPT

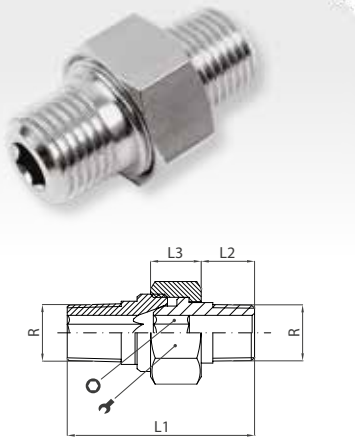

Kod produktu	R			L1 [mm]	L2 [mm]	L3 [mm]	ilość w opak.
LD 1818 K	1/8"	15	5	27	9	8,6	10 szt.
LD 1414 K	1/4"	19	6	33,5	11,5	9,6	10 szt.
LD 3838 K	3/8"	22	8	36	13	10	10 szt.
LD 1212 K	1/2"	27	12	45	15,5	12	10 szt.
LD 3434 K	3/4"	36	14	53	18	17	10 szt.
LD 11 K	1"	46	19	64	22	20	5 szt.

LD - ŁĄCZNIK ROZDZIELNY REDUKCYJNY Z GWINTAMI ZEWNĘTRZNYMI STOŻKOWYMI BSPT

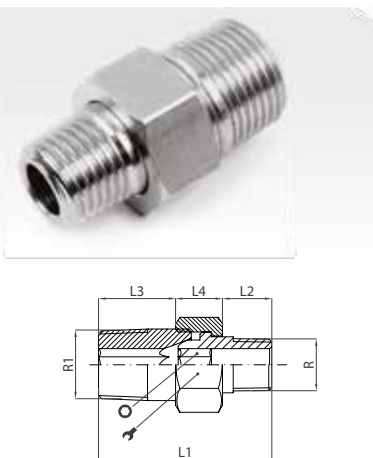

Kod produktu	R	R1			L1 [mm]	L2 [mm]	L3 [mm]	L4 [mm]	ilość w opak.
LD 1418 K	1/8"	1/4"	15	5	30	9	9,5	8,5	10 szt.
LD 3814 K	1/4"	3/8"	19	6	36	11,5	11,5	9,5	10 szt.
LD 1238 K	3/8"	1/2"	22	8	39	13	13,5	10	10 szt.

LDI - ŁĄCZNIK ROZDZIELNY Z GWINTEM ZEWNĘTRZNYM STOŻKOWYM BSPT - WEWNĘTRZNYM WALCOWYM BSPP

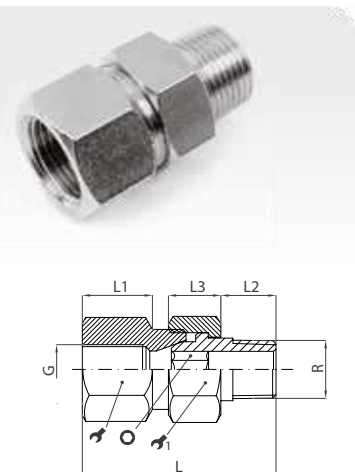

Kod produktu	R	G				L1 [mm]	L2 [mm]	L3 [mm]	L4 [mm]	ilość w opak.
LDI 1818 K	1/8"	1/8"	14	15	5	30,5	9	8,5	9	25 szt.
LDI 1414 K	1/4"	1/4"	17	19	6	37	12	9,5	12	25 szt.
LDI 3838 K	3/8"	3/8"	21	22	8	40	12	10	12	25 szt.
LDI 1212 K	1/2"	1/2"	25	27	12	48	15	12	15	25 szt.

VB - KOSTKA ROZDZIELCZA Z GWINTAMI WEWNĘTRZNYMI WALCOWYMI BSPP

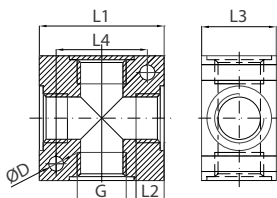

Kod produktu	G	D [Ø]	L1 [mm]	L2 [mm]	L3 [mm]	L4 [mm]	ilość w opak.
VB 18	1/8"	4,5	25	7	15	17	1 szt.
VB 14	1/4"	5,5	40	11	20	26	1 szt.
VB 38	3/8"	5,5	50	12	25	34	1 szt.
VB 12	1/2"	5,5	50	12	30	34	1 szt.
VB 34	3/4"	5,5	60	14	35	45	1 szt.

MU - MUFA Z GWINTAMI WEWNĘTRZNYMI WALCOWYMI BSPP

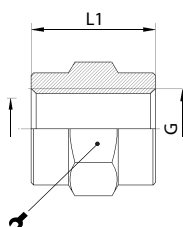
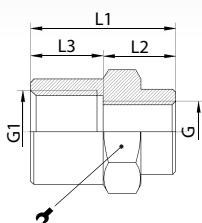

Kod produktu	G	G1		L1 [mm]	L2 [mm]	L3 [mm]	ilość w opak.
MU 1818	1/8"	1/8"	14	15			25 szt.
MU 1814		1/4"	17	22	8	10	25 szt.
MU 1838		3/8"	22	24	8	12	25 szt.
MU 1414	1/4"	1/4"	17	22			50 szt.
MU 1438		3/8"	22	23	8	8	25 szt.
MU 1412	1/2"	1/2"	25	24	10	12	25 szt.
MU 3838		3/8"	22	24			50 szt.
MU 3812		1/2"	25	24	10	12	50 szt.
MU 3834	3/8"	3/4"	32	30	10	14	25 szt.
MU 1212		1/2"	25	30			25 szt.
MU 1234	1/2"	3/4"	32	30	10	14	25 szt.
MU 3434		3/4"	32	31			25 szt.
MU 341	3/4"	1"	41	38	16	19	10 szt.
MU 11		1"	41	38			10 szt.

KM - NAKRĘTKA KONTRUJĄCA Z GWINTEM WALCOWYM BSPP LUB METRYCZNYM

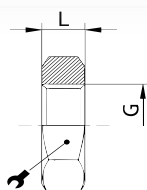

Kod produktu	G		L [mm]	ilość w opak.
KM 18	1/8"	14	4,5	25 szt.
KM 14	1/4"	17	5	25 szt.
KM 38	3/8"	20	5	25 szt.
KM 12	1/2"	24	6	25 szt.
KM 34	3/4"	30	6	25 szt.
KM 1	1"	41	6	25 szt.
KM 10 M	M10x1	14	4,5	25 szt.
KM 12 M	M12x1	17	4,5	25 szt.
KM 14 M	M14x1	17	5	25 szt.
KM 16 M	M16x1	19	5	25 szt.
KM 18 M	M18x1,5	22	5	25 szt.



UR/UL - NAKRĘTKA DOCISKOWA TULEI Z GWINTEM WEWNĘTRZNYM WALCOWYM BSPP

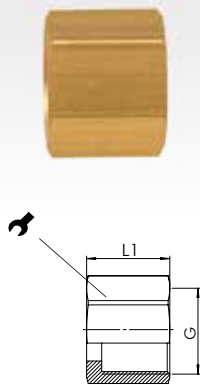

Kod produktu	G		L1 [mm]	ilość w opak.
UR 10	1/8" prawy	12	11	10
UR 13	1/4" prawy	17	15,5	10
UR 17	3/8" prawy	19	16,5	10
UR 21	1/2" prawy	24	20,5	10
UL 13	1/4" lewy	17	15,5	10
UL 17*	3/8" lewy	19	16,5	10
UL 21	1/2" lewy	24	20,5	10

Dostępne na zamówienie wersje nierdzewne

* wersja krótka, pasująca do wszystkich rozmiarów

STP - TULEJA KRÓTKA DO WĘŻA

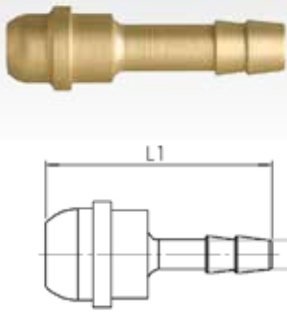

Kod produktu	G	D [Ø]	L1 [mm]	ilość w opak.
STP 10/04	1/8"	4	27,5	10
STP 10/06	1/8"	6	28	10
STP 13/04	1/4"	4	30,5	10
STP 13/06	1/4"	6	35,5	10
STP 13/09*	1/4"	9	35,5	10
STP 17/04	3/8"	4	31	10
STP 17/06	3/8"	6	36	10
STP 17/09	3/8"	9	36	10
STP 21/06	1/2"	6	38	10
STP 21/09	1/2"	9	38	10
STP 21/13	1/2"	13	44	10

Dostępne na zamówienie wersje nierdzewne

* stosowana z UR13

STD - TULEJA DŁUGA DO WĘŻA

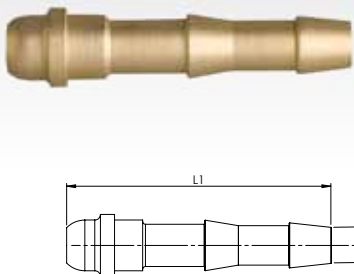

Kod produktu	G	D [Ø]	L1 [mm]	ilość w opak.
STD 13/04	1/4"	4	47	10
STD 13/06	1/4"	6	47	10
STD 17/04	3/8"	4	47,5	10
STD 17/06	3/8"	6	47,5	10
STD 17/09	3/8"	9	47,5	10

Tuleje STP i STD należy stosować z nakrętkami UR/UL

GT - TULEJA GWINTOWANA Z GWINTEM ZEWNĘTRZNYM BSPP

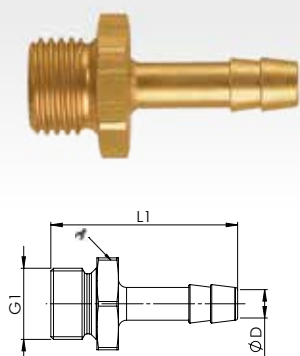

Kod produktu	G	D [Ø]		L1 [mm]	L2 [mm]	ilość w opak.
GT 05/03	M5	3	7	15,5	5	10
GT 05/04	M5	4	7	15,5	5	10
GT 06/04	M6	4	8	23	6	10
GT 10/04	1/8"	4*	14	28	7	10
GT 10/06	1/8"	6*	14	33	7	10
GT 10/08	1/8"	8*	14	33	7	10
GT 10/09	1/8"	9*	14	33	7	10
GT 13/04	1/4"	4*	17	30	9	10
GT 13/06	1/4"	6*	17	35	9	10
GT 13/08	1/4"	8*	17	35	9	10
GT 13/09	1/4"	9*	17	35	9	10
GT 13/13	1/4"	13*	17	42	9	10
GT 17/06	3/8"	6*	19	36	9	10
GT 17/08	3/8"	8*	19	36	9	10
GT 17/09	3/8"	9*	19	36	9	10
GT 17/13	3/8"	13*	19	42	9	10
GT 21/06	1/2"	6*	24	40	12	10
GT 21/09	1/2"	9*	24	40	12	10
GT 21/13	1/2"	13*	24	46	12	10
GT 26/13	3/4"	13*	32	52	16	10
GT 26/16	3/4"	16*	32	60	16	10
GT 26/19	3/4"	19*	32	60	16	10
GT 33/25	1"	25*	36	70	16	10

* wewnątrz stożek 45°

GI - TULEJA GWINTOWANA Z GWINTEM WEWNĘTRZNYM BSPP

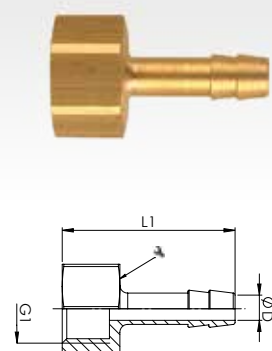

Kod produktu	G	D [Ø]		ilość w opak.
GI 10/06	1/8"	6	14	10
GI 10/08	1/8"	8	14	10
GI 13/06	1/4"	6	17	10
GI 13/08	1/4"	8	17	10
GI 13/09	1/4"	9	17	10
GI 13/13	1/4"	13	17	10
GI 17/06	3/8"	6	19	10
GI 17/08	3/8"	8	19	10
GI 17/09	3/8"	9	19	10
GI 17/13	3/8"	13	19	10
GI 21/06	1/2"	6	24	10
GI 21/08	1/2"	8	24	10
GI 21/09	1/2"	9	24	10
GI 21/13	1/2"	13	24	10



DS - TULEJA DWUSTRONNA DO WĘŻA

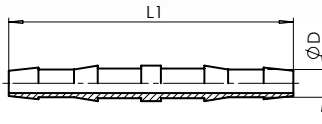

Kod produktu	D [Ø]	L1 [mm]	ilość w opak.
DS 04/04 P**	4	50	10
DS 06/06*	6	72	10
DS 08/08*	8	72	10
DS 09/09*	9	72	10
DS 13/13	13	74	10

* DIN EN 560

** dla PTFE, PE, PVDF

DK - TULEJA DWUSTRONNA DO WĘŻA, KRÓTKA

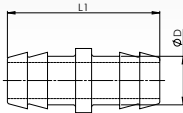

Kod produktu	D [Ø]	L1 [mm]	ilość w opak.
DK 04/04	4	19	10
DK 06/06	6	19	10

DN - ŁĄCZNIK Z GWINTAMI ZEWNĘTRZNYMI WALCOWYMI BSPP



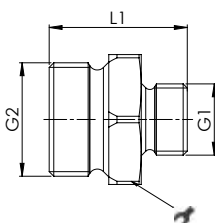

* stożek wewnętrzny 45°
 ** stożek wewnętrzny 45°,
 stosowany tylko z nakrętką UR175

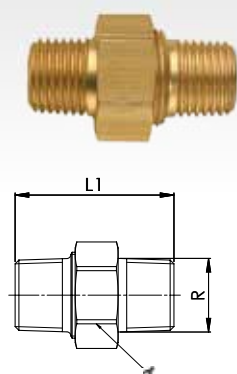

Kod produktu	G1	G2		L1 [mm]	ilość w opak.
DN 05/05	M5	M5	7	13	10
DN 05/13	M5	1/4"	17	19	10
DN 10/10	1/8"	1/8"	14	19	10
DN 10/10 K	1/8"	1/8"	12	21	10
DN 10/13	1/8"	1/4"	17	20	10
DN 10/17	1/8"	3/8"	19	21	10
DN 13/13	1/4"	1/4"	17	23	10
DN 13/13 K	1/4"	1/4"	14	30	10
DN 13/17	1/4"	3/8"	19	23	10
DN 13/21	1/4"	1/2"*	24	27	10
DN 17/17	3/8"	3/8"***	19	23	10
DN 17/17 K	3/8"	3/8"	17	30	10
DN 17/21	3/8"	1/2"***	24	27	10
DN 17/26	3/8"	3/4"***	32	33	10
DN 21/21	1/2"	1/2"*	24	30	10
DN 21/21 K	1/2"	1/2"	22	34	10
DN 21/26	1/2"	3/4"*	32	36	10
DN 21/33	1/2"	1"*	36	40	10
DN 26/26	3/4"	3/4"*	32	40	10
DN 26/33	3/4"	1"*	36	40	10
DN 33/33	1"	1"*	36	42	10
DN 13/13 L	1/4"	1/4"*	14	34	10
DN 13/17 L	1/4"	3/8"*	17	35,5	10
DN 17/17 L	3/8"	3/8"*	17	37	10

LD - ŁĄCZNIK ROZDZIELNY Z GWINTAMI ZEWNĘTRZNYMI STOŻKOWYMI BSPT



Kod produktu	R		L1 [mm]	ilość w opak.
LD 10/10 K	1/8"	15	27	10
LD 13/13 K	1/4"	19	34	10
LD 17/17 K	3/8"	22	37	10
LD 21/21 K	1/2"	27	44,5	10
LD 26/26 K	3/4"	36	53	10
LD 33/33 K	1"	46	64	10

RK - REDUKCJA KRÓTKA Z GWINTEM ZEWNĘTRZNYM WALCOWYM BSPP - WEWNĘTRZNYM WALCOWYM BSPP

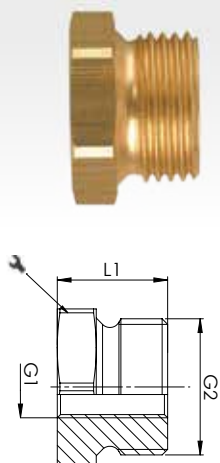

Kod produktu	G1	G2		L1 [mm]	ilość w opak.
RK 05/10	M5	1/8"	14	11	10
RK 05/13	M5	1/4"	17	14	10
RK 10/13	1/8"	1/4"	17	11	10
RK 10/17	1/8"	3/8"	19	13	10
RK 10/21	1/8"	1/2"	24	18	10
RK 13/17	1/4"	3/8"	19	14	10
RK 13/21	1/4"	1/2"	24	18	10
RK 17/21	3/8"	1/2"	24	18	10
RK 17/26	3/8"	3/4"	32	18	10
RK 21/26	1/2"	3/4"	32	24	10
RK 21/33	1/2"	1"	36	24,5	10
RK 26/33	3/4"	1"	36	21	10

RL - REDUKCJA DŁUGA Z GWINTEM ZEWNĘTRZNYM WALCOWYM BSPP - WEWNĘTRZNYM WALCOWYM BSPP

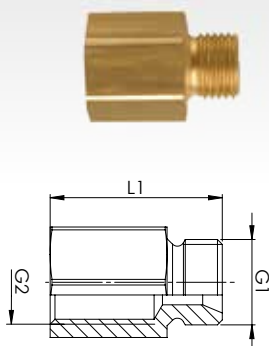

Kod produktu	G1	G2		L1 [mm]	ilość w opak.
RL 05/05	M5	M5	8	15	10
RL 05/10	M5	1/8"	14	17	10
RL 10/05	1/8"	M5	14	17	10
RL 10/10	1/8"	1/8"	14	23	10
RL 10/13	1/8"	1/4"	17	26	10
RL 13/10	1/4"	1/8"	17	26	10
RL 13/13	1/4"	1/4"	17	28	10
RL 13/17	1/4"	3/8"	19	29	10
RL 17/13	3/8"	1/4"	19	29	10
RL 17/17	3/8"	3/8"	19	29	10
RL 17/21	3/8"	1/2"	24	32	10
RL 21/17	1/2"	3/8"	24	34	10
RL 21/21	1/2"	1/2"	24	34	10
RL 21/26	1/2"	3/4"	32	31	10

* gwint stożkowy 45°



MU - MUFA Z GWINTAMI WEWNĘTRZNYMI WALCOWYMI BSPP

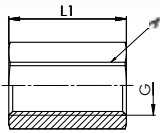

Kod produktu	G		L1 [mm]	ilość w opak.
MU 05	M5	8	12	10
MU 10	1/8"	14	22	10
MU 13	1/4"	17	26	10
MU 17	3/8"	22	26	10
MU 21	1/2"	27	30	10
MU 26	3/4"	32	36	10
MU 33	1"	41	40	10

VB - KOSTKA ROZDZIELCZA Z GWINTAMI WEWNĘTRZNYMI WALCOWYMI BSPP

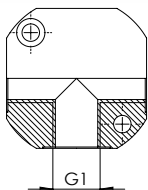

Kod produktu	G		ilość w opak.
VB 10	1/8"	30	10
VB 13	1/4"	36	10
VB 17	3/8"	43	10
VB 21	1/2"	52	10

VZ - KOREK Z GWINTEM ZEWNĘTRZNYM WALCOWYM BSPP

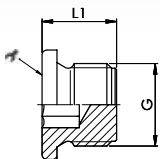

Kod produktu	G		L1 [mm]	ilość w opak.
VZ 05	M5	8	8	10
VZ 10	1/8"	5	11	10
VZ 13	1/4"	6	15	10
VZ 17	3/8"	8	15	10
VZ 21	1/2"	10	18	10
VZ 26	3/4"	12	20	10

Z sześciokątem wewnętrznym (DIN 908)

VK - KOREK Z GWINTEM ZEWNĘTRZNYM STOŻKOWYM BSPT

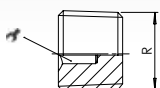

Kod produktu	R		ilość w opak.
VK 10	1/8"	5	10
VK 13	1/4"	7	10
VK 17	3/8"	8	10

Gwint stożkowy, z sześciokątem wewnętrznym (DIN 906)

PD - USZCZELNIENIE Z PVC

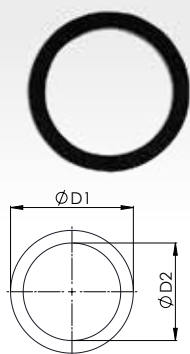

Kod produktu	G	D1 [Ø]	D2 [Ø]	ilość w opak.
PD 05	dla M5	7,82	5,24	10
PD 10	dla 1/8"	13	10,15	10
PD 13	dla 1/4"	17,91	13,23	10
PD 17	dla 3/8"	22	16,9	10
PD 21	dla 1/2"	26,46	21,2	10
PD 26	dla 3/4"	32,4	26,6	10

FD - USZCZELNIENIE Z FIBRY

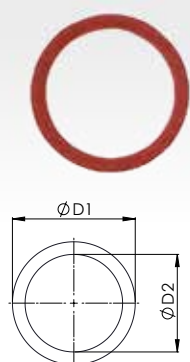

Kod produktu	G	D1 [Ø]	D2 [Ø]	ilość w opak.
FD 05	dla M5	9,15	5,2	10
FD 10	dla 1/8"	13,55	10,15	10
FD 13	dla 1/4"	17,73	13,25	10
FD 17	dla 3/8"	22,1	17	10
FD 21	dla 1/2"	26,48	21,24	10
FD 26	dla 3/4"	32,84	26,58	10

AD - USZCZELNIENIE Z ALUMINIUM

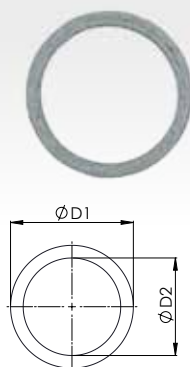

Kod produktu	G	D1 [Ø]	D2 [Ø]	ilość w opak.
AD 10	dla 1/8"	13,02	10,08	10
AD 13	dla 1/4"	17,01	13,45	10
AD 17	dla 3/8"	20,8	17,4	10
AD 21	dla 1/2"	27,8	21,2	10
AD 26	dla 3/4"	31,8	27,45	10
AD 33	dla 1"	38,8	33,45	10

DV - ZŁĄCZKA OBROTOWA Z GWINTEM ZEWNĘTRZNYM STOŻKOWYM BSPT

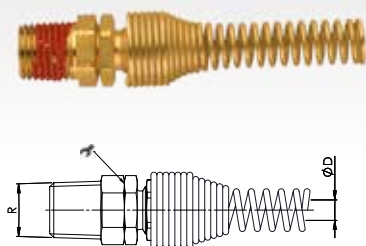



Kod produktu	R	D [Ø]		ilość w opak.
DV 10/05	1/8"	3,1x4,7	11	10
DV 13/06	1/4"	4,8x6,3	14	10
DV 13/08	1/4"	6,3x7,9	14	10
DV 13/10	1/4"	7,9x9,5	15	10
DV 17/12	3/8"	9,5x11,8	19	10
DV 21/16	1/2"	12,7x15,8	22	10

Złącza DV powinny być stosowane z węzami PU i PA o rozmiarach calowych.

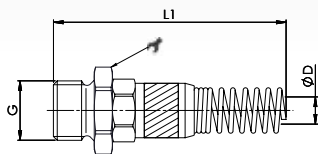

SV - ZŁĄCZKA PROSTA ZE SPRĘŻYNĄ WZMACNIAJĄCĄ I GWINTEM ZEWNĘTRZNYM WALCOWYM BSPP



Kod produktu	G	D [Ø]		L1 [mm]	ilość w opak.
SV 05/06	M5	4x6	8	103	10
SV 10/06	1/8"	4x6	12	103	10
SV 10/08	1/8"	6x8	12	106	10
SV 13/06	1/4"	4x6	17	103	10
SV 13/08	1/4"	6x8	17	106	10
SV 13/10	1/4"	8x10	17	119	10
SV 13/12	1/4"	9x12	17	123	10
SV 17/08	3/8"	6x8*	19	106	10
SV 17/10	3/8"	8x10*	19	119	10
SV 17/12	3/8"	9x12*	19	123	10

* stożek wewnętrzny 45°

TA - ZŁĄCZKA T Z GWINTAMI ZEWNĘTRZNYMI STOŻKOWYMI BSPT

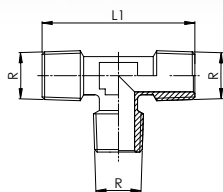

Kod produktu	R		L1 [mm]	ilość w opak.
TA 10*	1/8"	10	37	10
TA 13*	1/4"	13	47	10
TA 17*	3/8"	17	52	10
TA 21**	1/2"	19	60	10

* bez stożka wewnętrznego

** ze stożkiem wewnętrznym

WA - KOLANKO Z GWINTAMI ZEWNĘTRZNYMI STOŻKOWYMI BSPT

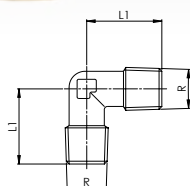

Kod produktu	R		L1 [mm]	ilość w opak.
WA 13*	1/4"	13	30	10
WA 17*	3/8"	17	33,5	10
WA 21**	1/2"	19	39	10

* bez stożka wewnętrznego

** ze stożkiem wewnętrznym

TI - ZŁĄCZKA T Z GWINTAMI WEWNĘTRZNYMI WALCOWYMI BSPP

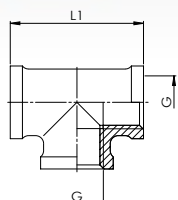

Kod produktu	G	L1 [mm]	ilość w opak.
TI 10	1/8"	34	10
TI 13	1/4"	38,5	10
TI 17	3/8"	44	10
TI 21	1/2"	44	10
TI 26	3/4"	50	10
TI 33	1"	64,5	10

WI - KOLANKO Z GWINTAMI WEWNĘTRZNYMI WALCOWYMI BSPP

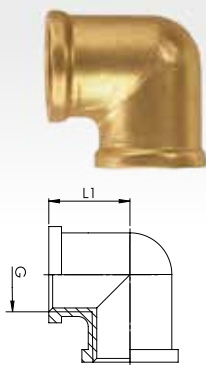

Kod produktu	G	L1 [mm]	ilość w opak.
WI 10	1/8"	25	10
WI 13	1/4"	29	10
WI 17	3/8"	35	10
WI 21	1/2"	40	10
WI 26	3/4"	47	10
WI 33	1"	55	10

YA - ZŁĄCZKA Y Z GWINTEM ZEWNĘTRZNYM STOŻKOWYM BSPT - WEWNĘTRZNYMI WALCOWYMI BSPP

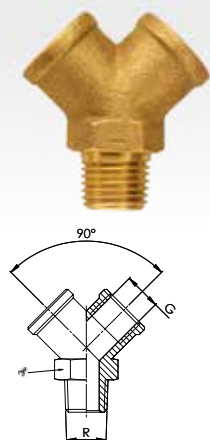

Kod produktu	G	R		ilość w opak.
YA 10	1/8"	1/8	13	10
YA 13	1/4"	1/4	17	10
YA 17	3/8"	3/8	20	10
YA 21	1/2"	1/2	25	10

YI - ZŁĄCZKA Y Z GWINTAMI WEWNĘTRZNYMI WALCOWYMI BSPP

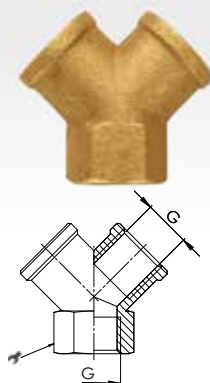

Kod produktu	G		ilość w opak.
YI 10	1/8"	13	10
YI 13	1/4"	17	10
YI 17	3/8"	20	10
YI 21	1/2"	25	10

ZO - DWÓJNIK Z GWINTAMI WEWNĘTRZNYMI WALCOWYMI BSPP

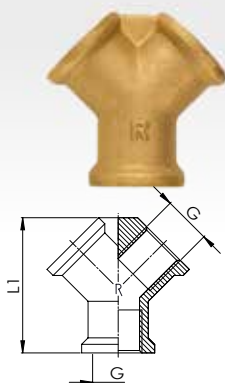

Kod produktu	G	L1 [mm]	ilość w opak.
ZO 17	3/8" w.	47	10
ZO 21	1/2" w.	55	10



DO - TRÓJNIK Z GWINTAMI WEWNĘTRZNYMI WALCOWYMI BSPP

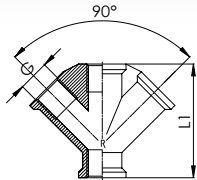

Kod produktu	G	L1 [mm]	ilość w opak.
DO 17	3/8"	61	10
DO 21	1/2"	67	10

ZM - DWÓJNIK Z SZYBKOZŁĄCZAMI SERII 26KA

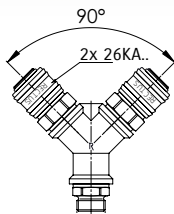

Kod produktu	G	ilość w opak.
ZM 13 A	1/4" z.	10
ZM 17 A	3/8" z.	10
ZM 21 A	1/2" z.	10
ZM 13 I	1/4" w.	10
ZM 17 I	3/8" w.	10
ZM 21 I	1/2" w.	10

DM - TRÓJNIK Z SZYBKOZŁĄCZAMI SERII 26KA

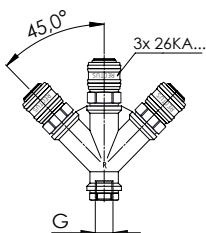

Kod produktu	G	ilość w opak.
DM 13 A	1/4" z.	10
DM 17 A	3/8" z.	10
DM 21 A	1/2" z.	10
DM 13 I	1/4" w.	10
DM 17 I	3/8" w.	10
DM 21 I	1/2" w.	10

WD - ROZDZIELACZ Z SZYBKOZŁĄCZAMI SERII 26KA

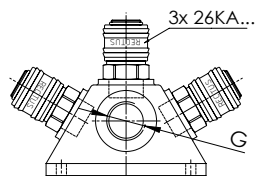

Kod produktu	G	ilość w opak.
WD 17-26	3/8" w.	10
WD 21-26	1/2" w.	10

WD - ROZDZIELACZ Z GWINTAMI WEWNĘTRZNYMI WALCOWYMI BSPP

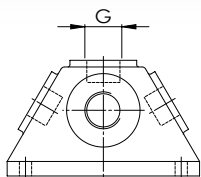

Kod produktu	G	ilość w opak.
WD 17	3/8" w.	10
WD 21	1/2" w.	10







ZAWORY PNEUMATYCZNE



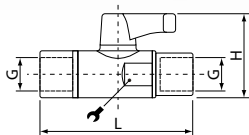

BVC1 F SERIA MIKRO - ZAWÓR KULOWY Z GWINTAMI WEWNĘTRZNYMI WALCOWYMI BSPP

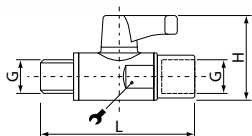

Kod produktu	G		DN	L [mm]	H [mm]
BVC1 F18 B (niebieski)	1/8"	14	5,5	39,5	29
BVC1 F18 R (czerwony)	1/8"	14	5,5	39,5	29
BVC1 F14 B (niebieski)	1/4"	14	5,5	44,5	29
BVC1 F14 R (czerwony)	1/4"	14	5,5	44,5	29

BVC1 MF SERIA MIKRO - ZAWÓR KULOWY Z GWINTEM ZEWNĘTRZNYM WALCOWYM BSPP - WEWNĘTRZNYM WALCOWYM BSPP



Kod produktu	G		DN	L [mm]	H [mm]
BVC1 MF18 B (niebieski)	1/8"	14	5,5	39	29
BVC1 MF18 R (czerwony)	1/8"	14	5,5	39	29
BVC1 MF14 B (niebieski)	1/4"	14	5,5	44,5	29
BVC1 MF14 R (czerwony)	1/4"	14	5,5	44,5	29

BVC2 F SERIA MINI - ZAWÓR KULOWY Z GWINTAMI WEWNĘTRZNYMI WALCOWYMI BSPP

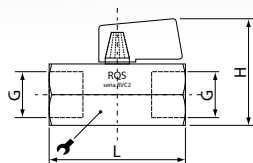

Kod produktu	G		DN	L [mm]	H [mm]
BVC2 F14	1/4"	20	8	39	37
BVC2 F38	3/8"	20	8	42	37
BVC2 F12	1/2"	24	10	47	41

BVC2 MF SERIA MINI - ZAWÓR KULOWY Z GWINTEM ZEWNĘTRZNYM WALCOWYM BSPP - WEWNĘTRZNYM WALCOWYM BSPP

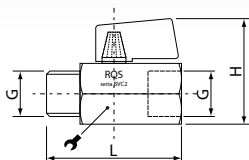

Kod produktu	G		DN	L [mm]	H [mm]
BVC2 MF14	1/4"	20	8	39	37
BVC2 MF38	3/8"	20	8	40	37
BVC2 MF12	1/2"	24	10	45	41



SVB - ZAWÓR SUWAKOWY RĘCZNY 3/2 Z GWINTAMI WEWNĘTRZNYMI WALCOWYMI BSPP

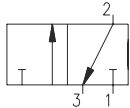
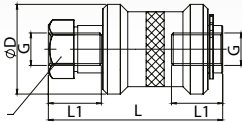

Kod produktu	G		L [mm]	L1 [mm]	D [mm]
SVB F18	1/8"	14	48	15	25
SVB F14	1/4"	19	58	12,5	30
SVB F38	3/8"	22	70	13	35
SVB F12	1/2"	27	75	15	40
SVB F34	3/4"	32	83	16,5	49

BV110 - ZAWÓR KULOWY RĘCZNY MINI ZE STALI NIERDZEWNEJ AISI 316

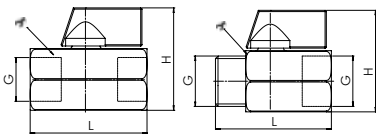

Kod produktu (wew./wew.)	G		L [mm]	H [mm]
BV110 FG02 S6P ...*	1/4"	21	42	38
BV110 FG03 S6P ...*	3/8"	21	42	38
BV110 FG04 S6P ...*	1/2"	24,5	46	40,5

Kod produktu (zew./wew.)	G		L [mm]	H [mm]
BV110 FMG02 S6P ...*	1/4"	21	40	38
BV110 FMG03 S6P ...*	3/8"	21	40	38
BV110 FMG04 S6P ...*	1/2"	24,5	46	40,5

*R – czerwony uchwyt, B – niebieski uchwyt

DRV - ZAWÓR REDUKCJI CIŚNIENIA Z GWINTEM WEWNĘTRZNYM WALCOWYM BSPP - ZEWNĘTRZNYM STOŻKOWYM BSPT

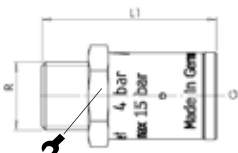

Kod produktu	G	R		L1 [mm]	max. ciśnienie zasilające	stałe ciśnienie zasilające	ilość w opak.
DRV 13/30	1/4	1/4"	17	34	15 bar	3,0 bar	10
DRV 13/40	1/4	1/4"	17	34	15 bar	4,0 bar	10
DRV 13/50	1/4	1/4"	17	34	15 bar	5,0 bar	10
DRV 13/60	1/4	1/4"	17	34	15 bar	6,0 bar	10



INSTRUMENTATION



FLUID
CONNECTORS



PNEUMATIC
AUTOMATION



PROCESS
VALVES

Wersja 08.2021